



RAM



OWNER'S MANUAL

2025 RAM 1500

ROADSIDE ASSISTANCE

24 HOURS, 7 DAYS A WEEK AT YOUR SERVICE.

CALL 1-800-521-2779 OR VISIT CHRYSLER.RSAHELP.COM (USA)

CALL 1-800-363-4869 OR VISIT FCA.ROADSIDEAID.COM (CANADA)

SERVICES: Flat Tire Service, Out Of Gas/Fuel Delivery, Battery Jump Assistance, Lockout Service and Towing Service.

FCA US LLC reserves the right to modify the terms or discontinue the Roadside Assistance Program at any time. The Roadside Assistance Program is subject to restrictions and conditions of use, that are determined solely by FCA US LLC.

Please see the Customer Assistance chapter in this Owner's Manual for further information.

⚠ WARNING: Operating, servicing and maintaining a passenger vehicle or off-highway motor vehicle can expose you to chemicals including engine exhaust, carbon monoxide, phthalates, and lead, which are known to the State of California to cause cancer and birth defects or other reproductive harm. To minimize exposure, avoid breathing exhaust, do not idle the engine except as necessary, service your vehicle in a well-ventilated area and wear gloves or wash your hands frequently when servicing your vehicle. For more information go to: **www.P65Warnings.ca.gov/passenger-vehicle**.

This Owner's Manual illustrates and describes the operation of features and equipment that are either standard or optional on this vehicle. This manual may also include a description of features and equipment that are no longer available or were not ordered on this vehicle. Please disregard any features and equipment described in this manual that are not on this vehicle. FCA US LLC reserves the right to make changes in design and specifications, and/or make additions to or improvements to its products without imposing any obligation upon itself to install them on products previously manufactured.

With respect to any vehicles sold in Canada, the name FCA US LLC shall be deemed to be deleted and the name FCA Canada Inc. used in substitution therefore.

Vehicle images are for illustration purposes only. Actual products sold may vary.

CONTENTS

1	INTRODUCTION	9
2	GETTING TO KNOW YOUR VEHICLE.....	17
3	GETTING TO KNOW YOUR INSTRUMENT PANEL.....	109
4	STARTING AND OPERATING.....	137
5	MULTIMEDIA	227
6	SAFETY	282
7	IN CASE OF EMERGENCY.....	331
8	SERVICING AND MAINTENANCE.....	349
9	TECHNICAL SPECIFICATIONS.....	411
10	CUSTOMER ASSISTANCE.....	418
11	INDEX.....	423

1

2

3

4

5

6

7

8

9

10

11

INTRODUCTION.....		
WELCOME.....	9	
SYMBOLS KEY.....	10	
VAN CONVERSIONS/CAMPERS	10	
CONSUMER INFORMATION – TRUCK- CAMPER LOADING.....	10	
VEHICLE MODIFICATIONS/ALTERATIONS	12	
SYMBOL GLOSSARY.....	12	
GETTING TO KNOW YOUR VEHICLE		
DIGITAL KEY – IF EQUIPPED.....	17	
Owner Digital Key Pairing.....	17	
KEYS	19	
Key Fob.....	19	
SENTRY KEY.....	22	
START BUTTON.....	22	
Keyless Enter 'n Go™ Ignition.....	22	
REMOTE START – IF EQUIPPED.....	23	
How To Use Remote Start.....	24	
To Exit Remote Start Mode.....	24	
Remote Start Front Defrost Activation – If Equipped.....	25	
Remote Start Comfort Systems – If Equipped.....	25	
Remote Start Windshield Wiper De-Icer Activation – If Equipped.....	25	
Remote Start Abort Message.....	25	
VEHICLE SECURITY SYSTEM – IF EQUIPPED....	25	
To Arm The System.....	26	
To Disarm The System.....	26	
Rearming Of The System.....	26	
Security System Manual Override.....	26	
DOORS	26	
Manual Door Locks.....	26	
Power Door Locks – If Equipped	27	
Power Side Steps – If Equipped	27	
Keyless Enter 'n Go™ – Passive Entry – If Equipped.....	28	
Automatic Unlock Doors On Exit – If Equipped.....	29	
Automatic Door Locks – If Equipped	29	
Child-Protection Door Lock System – Rear Doors.....	29	
STEERING WHEEL	30	
Tilt/Telescoping Steering Column	30	
Heated Steering Wheel – If Equipped.....	30	
DRIVER MEMORY SETTINGS – IF EQUIPPED....	31	
Programming The Memory Feature.....	31	
Linking And Unlinking The Key Fob To Memory.....	32	
Memory Position Recall.....	32	
SEATS	32	
Manual Adjustment Front Seats – If Equipped.....	32	
Manual Adjustment Rear Seats.....	33	
Power Adjustment Front Seats – If Equipped.....	34	
Power Seat Massage – If Equipped.....	36	
Heated Seats – If Equipped.....	37	
Ventilated Seats – If Equipped.....	37	
Plastic Grocery Bag Retainers – If Equipped	38	
Head Restraints.....	38	
UCONNECT VOICE RECOGNITION – IF EQUIPPED.....	41	
Introducing Voice Recognition.....	41	
Basic Voice Commands.....	41	
Get Started.....	41	
Additional Information.....	42	
DRIVER ADJUSTABLE PEDALS – IF EQUIPPED	42	
MIRRORS.....	43	
Inside Rearview Mirror.....	43	
Illuminated Vanity Mirror – If Equipped.....	45	
Outside Mirrors	45	
Outside Automatic Dimming Mirrors – If Equipped.....	47	
Power Mirrors.....	47	
Power Folding Outside Mirrors – If Equipped.....	47	
Automatic Power Folding Mirrors – If Equipped.....	48	
Power Convex Mirror Switch – If Equipped..	48	
Forward Utility Lights and Rear Guidance Lights – If Equipped.....	49	
Heated Mirrors – If Equipped	49	
UNIVERSAL GARAGE DOOR OPENER (HOMELINK®) – IF EQUIPPED.....	50	
Before You Begin Programming HomeLink®.....	50	
Erasing All The HomeLink® Channels.....	50	
Identifying Whether You Have A Rolling Code Or Non-Rolling Code Device.....	50	

Programming HomeLink® To A Garage			
Door Opener.....	50		
Programming HomeLink® To A			
Miscellaneous Device.....	51		
Reprogramming A Single HomeLink®			
Button.....	51		
Canadian/Gate Operator Programming.....	52		
Security.....	52		
Troubleshooting Tips.....	52		
EXTERIOR LIGHTS	53		
Headlight Switch	53		
Multifunction Lever	54		
Daytime Running Lights (DRLs).....	54		
High/Low Beam Switch	54		
Automatic High Beam Headlamp			
Control – If Equipped	54		
Flash-To-Pass	54		
Automatic Headlights – If Equipped.....	54		
Parking Lights And Panel Lights.....	55		
Automatic Headlights With Wipers.....	55		
Headlight Illumination On Approach.....	55		
Headlight Delay.....	55		
Lights-On Reminder.....	56		
Fog Lights – If Equipped	56		
Turn Signals	56		
Lane Change Assist – If Equipped.....	56		
Cargo Lights/Trailer Spotter Lights/ Trailer Hitch Light With Bed Lights – If Equipped.....	56		
Battery Saver.....	57		
INTERIOR LIGHTS	57		
Courtesy Lights.....	57		
Illuminated Entry.....	59		
WINDSHIELD WIPERS AND WASHERS	59		
Windshield Wiper Operation.....	59		
Rain Sensing Wipers – If Equipped	60		
CLIMATE CONTROLS	60		
Automatic Climate Control Descriptions			
And Functions.....	60		
Manual Climate Control Descriptions			
And Functions.....	63		
Automatic Temperature Control (ATC) – If Equipped.....	65		
Climate Voice Recognition – If Equipped....	65		
Operating Tips	65		
INTERIOR STORAGE AND EQUIPMENT.....	66		
Storage.....	66		
USB/AUX Control	70		
Electrical Power Outlets	72		
Power Panel – If Equipped.....	73		
Power Inverter – If Equipped	75		
Wireless Charging Pad – If Equipped	76		
WINDOWS	78		
Power Windows.....	78		
Automatic Window Features.....	79		
Reset Auto-Up	79		
Window Lockout Switch.....	79		
Power Sliding Rear Window – If Equipped... 79			
Wind Buffeting	80		
POWER SUNROOF – IF EQUIPPED	80		
Single Pane Power Sunroof.....	80		
Dual Pane Power Sunroof.....	81		
HOOD	82		
To Open The Hood.....	82		
To Close The Hood.....	83		
TAILGATE.....	83		
Opening.....	83		
Closing.....	84		
Power Tailgate– If Equipped.....	84		
Multifunction Tailgate – If Equipped.....	85		
Locking Tailgate.....	86		
Tailgate Removal.....	86		
Installing The Tailgate.....	88		
Power Tailgate Removal.....	90		
Installing The Power Tailgate.....	93		
Bed Step – If Equipped.....	95		
PICKUP BOX	96		
Bed Rail Tie-Down System – If Equipped.... 97			
RAMBOX – IF EQUIPPED	98		
Locking And Unlocking RamBox.....	98		
RamBox Cargo Storage Bins.....	98		
RamBox Safety Warning.....	100		
Bed Divider – If Equipped.....	100		
TRI-FOLD TONNEAU COVER – IF EQUIPPED.... 102			
Tonneau Cover Components.....	102		
Tri-Fold Tonneau Cover Folding For Driving Or Removal.....	103		
Tri-Fold Tonneau Cover Installation.....	106		
Tri-Fold Tonneau Cover Cleaning.....	108		
GETTING TO KNOW YOUR INSTRUMENT PANEL			
BASE INSTRUMENT CLUSTER.....	109		

Base Instrument Cluster Descriptions.....	110
HIGHLINE INSTRUMENT CLUSTER.....	111
Highline Instrument Cluster Descriptions..	111
PREMIUM INSTRUMENT CLUSTER.....	113
Premium Instrument Cluster Descriptions	113
PREMIUM INSTRUMENT CLUSTER – RHO.....	115
Premium Instrument Cluster	
Descriptions – RHO.....	115
INSTRUMENT CLUSTER DISPLAY.....	116
Instrument Cluster Display Location	
and Controls.....	116
Oil Life Reset.....	118
Display Menu Items.....	119
Head Up Display (HUD) – If Equipped.....	124
RHO Drive Mode.....	125
Battery Saver On/Battery Saver Mode	
Message – Electrical Load	
Reduction Actions – If Equipped.....	125
WARNING LIGHTS AND MESSAGES.....	126
Red Warning Lights.....	126
Yellow Warning Lights.....	129
Yellow Indicator Lights.....	132
Green Indicator Lights.....	133
Drive Mode Indicator Lights.....	134
White Indicator Lights.....	134
Blue Indicator Lights.....	134
ONBOARD DIAGNOSTIC SYSTEM – OBD II	135
Onboard Diagnostic System (OBD II)	
Cybersecurity.....	135
EMISSIONS INSPECTION AND	
MAINTENANCE PROGRAMS	135

STARTING AND OPERATING

STARTING THE ENGINE	137
Automatic Transmission.....	137
AutoPark.....	137
Tip Start Feature	138
Keyless Enter 'n Go™ – Ignition.....	138
Normal Starting Using ENGINE START/	
STOP Button	138
Extended Park Starting.....	139
If Engine Fails To Start	139
After Starting.....	140
ENGINE BLOCK HEATER – IF EQUIPPED.....	140
ENGINE BREAK-IN RECOMMENDATIONS.....	140
PARKING BRAKE	140
Electric Park Brake (EPB)	140
AUTOMATIC TRANSMISSION	143
Ignition Park Interlock.....	143
Brake/Transmission Shift Interlock	
(BTSI) System	143
8-Speed Automatic Transmission	144
FOUR-WHEEL DRIVE OPERATION – IF	
EQUIPPED.....	147
Four-Position Electronically Shifted	
Transfer Case – If Equipped.....	147
Five-Position Electronically Shifted	
Transfer Case – If Equipped.....	149
FOUR-WHEEL DRIVE OPERATION – RHO.....	151
Four-Position Electronically Shifted	
Transfer Case.....	151
Selec-Speed Control (SSC)	154
RHO Modes.....	155

ACTIVE-LEVEL FOUR CORNER AIR	
SUSPENSION SYSTEM – IF EQUIPPED	157
Description.....	157
Air Suspension Modes.....	159
Instrument Cluster Display Messages.....	159
Operation.....	159
ACTIVE-LEVEL FOUR CORNER AIR	
SUSPENSION SYSTEM (OFF-ROAD	
GROUP) – IF EQUIPPED	160
Description.....	160
Air Suspension Modes.....	161
Instrument Cluster Display Messages.....	161
Operation.....	161
ACTIVE NOISE CANCELLATION.....	162
AXLE LOCK SYSTEM – IF EQUIPPED.....	162
LIMITED-SLIP DIFFERENTIAL – IF EQUIPPED	163
POWER STEERING.....	163
Electric Power Steering	163
STOP/START SYSTEM – IF EQUIPPED.....	164
Autostop Mode.....	164
Possible Reasons The Engine Does Not	
Autostop.....	164
To Start The Engine While In Autostop	
Mode.....	165
To Manually Turn Off The Stop/Start	
System.....	165
To Manually Turn On The Stop/Start	
System.....	165
System Malfunction.....	165
CRUISE CONTROL SYSTEMS.....	166
Adaptive Cruise Control (ACC).....	166

TRAFFIC SIGN ASSIST SYSTEM — IF EQUIPPED.....	173	Turning Active Driving Assist On Or Off.....	188	REFUELING THE VEHICLE	204
Activation/Deactivation.....	173	Indications On The Display.....	190	VEHICLE LOADING	205
Traffic Sign Assist Modes.....	173	System Status.....	190	Certification Label.....	205
Indications On The Display.....	174	System Operation/Limitations.....	190	TRAILER TOWING	206
ROUGH ROAD CRUISE CONTROL (RRCC) — IF EQUIPPED.....	174	HANDS-FREE ACTIVE DRIVING ASSIST SYSTEM — IF EQUIPPED.....	191	Common Towing Definitions.....	206
Rough Road Cruise Control (RRCC) Operation.....	175	Operation.....	191	Trailer Hitch Type and Maximum Trailer Weight.....	208
PARKSENSE FRONT/REAR PARK ASSIST SYSTEM	175	Hands-Free Sub Features.....	192	Trailer Towing Weights (Maximum Trailer Weight Ratings)	209
ParkSense Sensors.....	176	Turning Active Driving Assist On Or Off.....	194	Trailer And Tongue Weight	209
ParkSense Warning Display.....	176	Indications On The Display.....	196	Trailer Hitch Assist — If Equipped.....	209
ParkSense Display.....	176	System Status.....	196	Trailer Reverse Steering Control — If Equipped.....	211
Enabling And Disabling Front And/Or Rear ParkSense.....	179	System Operation/Limitations.....	196	Towing Requirements	213
Service The ParkSense Park Assist System.....	179	ACTIVE LANE MANAGEMENT SYSTEM — IF EQUIPPED.....	197	Towing Tips	217
Cleaning The ParkSense System.....	179	Active Lane Management Operation.....	197	RECREATIONAL TOWING (BEHIND MOTORHOME).....	218
ParkSense System Usage Precautions.....	179	Turning Active Lane Management On Or Off.....	198	Towing This Vehicle Behind Another Vehicle.....	218
PARKSENSE ACTIVE PARK ASSIST SYSTEM — IF EQUIPPED.....	180	Active Lane Management Warning Message.....	198	Recreational Towing — Two-Wheel Drive Models.....	218
Enabling And Disabling The ParkSense Active Park Assist System.....	181	Changing Active Lane Management Status.....	199	Recreational Towing — Four-Wheel Drive Models.....	219
ParkSense Automatic Park Assist — Assist Mode.....	182	PARKVIEW REAR BACK UP CAMERA — IF EQUIPPED	200	DRIVING TIPS.....	220
ParkSense Automatic Park Assist — Steering-Only Mode.....	185	SURROUND VIEW CAMERA SYSTEM — IF EQUIPPED.....	201	Driving On Slippery Surfaces	220
BASE ACTIVE DRIVING ASSIST SYSTEM — IF EQUIPPED.....	187	Forward Facing Camera With Tire Lines — If Equipped.....	203	Driving Through Water	221
Operation.....	187	Turn Signal Activated Blind Spot Assist — If Equipped.....	204	Off-Road Driving Tips	221
		TRAILER CAMERAS — IF EQUIPPED.....	204	DRIVING TIPS — RHO.....	222
		AUX Camera — If Equipped.....	204	On-Road Driving Tips.....	222
				Off-Road Driving Tips.....	222

MULTIMEDIA

UCONNECT SYSTEMS	227	Regulatory And Safety Information.....	274	Supplemental Restraint Systems (SRS).....	307
CYBERSECURITY	227	OFF-ROAD PAGES — IF EQUIPPED.....	275	Child Restraints	317
UCONNECT SETTINGS.....	227	Off-Road Pages Status Bar	275	SAFETY TIPS	328
Customer Programmable Features	228	Vehicle Dynamics	276	Transporting Passengers.....	328
STEERING WHEEL AUDIO CONTROLS.....	255	Accessory Gauge.....	277	Transporting Pets	328
Radio Operation.....	256	Pitch & Roll.....	277	Connected Vehicles.....	328
Media Mode.....	256	Suspension — If Equipped.....	278	Safety Checks You Should Make Inside	
PASSENGER SCREEN — IF EQUIPPED	256	Forward Facing Camera— If Equipped.....	279	The Vehicle	328
Passenger Screen Permissions.....	256	TRAILER TOW — IF EQUIPPED.....	279	Periodic Safety Checks You Should	
Home Screen.....	256	Trailer Info.....	279	Make Outside The Vehicle.....	329
Audio And Video.....	257	Cameras.....	279	Exhaust Gas	329
HDMI Projecting.....	258	Light Check.....	280	Carbon Monoxide Warnings	330
Device Manager.....	259	Setup.....	281		
Navigation.....	259	SAFETY		IN CASE OF EMERGENCY	
Camera.....	259	SAFETY FEATURES.....	282	HAZARD WARNING FLASHERS	331
PERFORMANCE PAGES — IF EQUIPPED.....	259	Anti-Lock Brake System (ABS)	282	ASSIST AND SOS SYSTEM — IF EQUIPPED.....	332
Timers.....	260	Electronic Brake Control (EBC) System	282	JACKING AND TIRE CHANGING	334
Gauges.....	261	Drowsy Driver Detection (DDD) — If		Preparations For Jacking.....	334
G-Force.....	261	Equipped.....	288	Jack Location.....	335
Dynamometer (Dyno)/Engine.....	261	Audible Pedestrian Warning System - If		Removal Of Jack And Tools.....	335
Vehicle Dynamics.....	262	Equipped.....	288	Removing The Spare Tire.....	336
DRIVE MODES.....	262	Rear Seat Reminder Alert (RSRA).....	289	Jacking Instructions.....	338
On-Road.....	263	AUXILIARY DRIVING SYSTEMS.....	289	To Stow The Flat Or Spare	340
Off-Road.....	265	Blind Spot Monitoring (BSM).....	289	Reinstalling The Jack And Tools.....	341
Custom Mode.....	266	Forward Collision Warning (FCW) With		JUMP STARTING	342
Race Options.....	269	Mitigation — If Equipped.....	294	Preparations For Jump Start.....	342
Guidelines For Track Or Extreme Off-		Tire Pressure Monitoring System (TPMS) .	297	Jump Starting Procedure.....	343
Road Use.....	273	OCCUPANT RESTRAINT SYSTEMS	302	REFUELING IN EMERGENCY.....	344
Valet Mode.....	274	Occupant Restraint Systems Features	302	IF YOUR ENGINE OVERHEATS	344
RADIO OPERATION AND MOBILE PHONES	274	Important Safety Precautions.....	302	MANUAL PARK RELEASE.....	345
		Seat Belt Systems	302	FREEING A STUCK VEHICLE	346
				TOWING A DISABLED VEHICLE	346

Two-Wheel Drive Models.....	347
Four-Wheel Drive Models.....	348
Emergency Tow Hooks – If Equipped.....	348
ENHANCED ACCIDENT RESPONSE	
SYSTEM (EARS).....	348
EVENT DATA RECORDER (EDR).....	348
SERVICING AND MAINTENANCE	
SCHEDULED SERVICING.....	349
Maintenance Plan.....	349
SCHEDULED SERVICING – RHO.....	353
Maintenance Plan.....	354
ENGINE COMPARTMENT	357
3.0L Engine – Standard Output.....	357
3.0L Engine – High Output.....	358
3.6L Engine With Stop/Start	359
Checking Oil Level – 3.0L Engines.....	360
Checking Oil Level – 3.6L Engine.....	361
Adding Washer Fluid	361
Maintenance-Free 12 Volt Battery.....	361
Pressure Washing.....	362
VEHICLE MAINTENANCE.....	362
Engine Oil	362
Engine Oil Filter	363
Engine Air Cleaner Filter.....	363
Air Conditioner Maintenance	363
Accessory Drive Belt Inspection.....	365
Body Lubrication	366
Windshield Wiper Blades	366
Exhaust System	367
Cooling System	368
Brake System	370

Automatic Transmission	371
Rear Axle And 4x4 Front Driving Axle	
Fluid Level	371
Transfer Case	372
Fuses.....	372
Bulb Replacement	389
TIRES.....	391
Tire Safety Information	391
Tires – General Information	397
Tire Types.....	400
Spare Tires – If Equipped	401
Wheel And Wheel Trim Care	402
Snow Traction Devices	403
Tire Rotation Recommendations	405
DEPARTMENT OF TRANSPORTATION	
UNIFORM TIRE QUALITY GRADES.....	405
Treadwear.....	405
Traction Grades.....	406
Temperature Grades.....	406
STORING THE VEHICLE	406
Battery Storage Mode – RHO.....	406
BODYWORK.....	407
Protection From Atmospheric Agents	407
Body And Underbody Maintenance.....	407
Preserving The Bodywork.....	407
INTERIORS	408
Seats And Fabric Parts.....	408
Plastic And Coated Parts.....	409
Leather Surfaces.....	409
Glass Surfaces	410

TECHNICAL SPECIFICATIONS

VEHICLE IDENTIFICATION NUMBER (VIN).....	411
BRAKE SYSTEM	411
WHEEL AND TIRE TORQUE SPECIFICATIONS .	411
Torque Specifications	411
FUEL REQUIREMENTS	412
3.0L Standard Output Engine	412
3.0L High Output Engine – RHO	412
3.6L Engine	412
Clean Air Gasoline.....	412
Reformulated Gasoline	412
Materials Added To Fuel	412
Gasoline/Oxygenate Blends	413
Do Not Use E-85 In Non-Flex Fuel Vehicles.....	413
Compressed Natural Gas (CNG) And	
Liquid Propane (LP) Fuel System	
Modifications.....	413
Methylcyclopentadienyl Manganese	
Tricarbonyl (MMT).....	413
Fuel System Cautions.....	413
FLUID CAPACITIES.....	414
ENGINE FLUIDS AND LUBRICANTS.....	415
CHASSIS FLUIDS AND LUBRICANTS.....	417
CUSTOMER ASSISTANCE	
SUGGESTIONS FOR OBTAINING SERVICE	
FOR YOUR VEHICLE.....	418
Prepare For The Appointment.....	418
Prepare A List.....	418
Be Reasonable With Requests.....	418
IF YOU NEED ASSISTANCE.....	418

Roadside Assistance.....	418
FCA US LLC Customer Assistance Center..	419
FCA Canada Customer Care.....	419
Mexico.....	419
Puerto Rico And US Virgin Islands.....	420
Customer Assistance For The Hearing Or Speech Impaired (TDD/TTY).....	420
Service Contract.....	420
WARRANTY INFORMATION.....	420
MOPAR® PARTS.....	420
REPORTING SAFETY DEFECTS.....	421
In The 50 United States And Washington, D.C.....	421
In Canada.....	421
ORDERING AND ACCESSING ADDITIONAL OWNER'S INFORMATION.....	421
CHANGE OF OWNERSHIP OR ADDRESS.....	421
GENERAL INFORMATION.....	422

INTRODUCTION

WELCOME

Dear Customer,

Congratulations on the purchase of your new Ram vehicle. Be assured that it represents precision workmanship, distinctive styling, and high quality.



This is a specialized utility vehicle. It can go places and perform tasks that are not intended for conventional passenger vehicles. It handles and maneuvers differently from many passenger vehicles both on-road and off-road, so take time to become familiar with your vehicle. If equipped, the two-wheel drive version of this vehicle was designed for on-road use only. It is not intended for off-road driving or use in other severe conditions suited for a four-wheel drive vehicle. Before you start to drive this vehicle, read the Owner's Manual. Be sure you are familiar with all vehicle controls, particularly those used for braking, steering and transmission. Learn how your vehicle handles on different road surfaces. Your driving skills will improve with experience. When driving off-road, or working the vehicle, don't overload the vehicle or expect the vehicle to overcome the natural laws of physics. Always observe federal, state, provincial and local laws wherever you drive. As with other vehicles of this type, failure to operate this vehicle correctly may result in loss of control or a collision ➞ page 220.

This Owner's Manual has been prepared with the assistance of service and engineering specialists to acquaint you with the operation and maintenance of your vehicle. It is supplemented by customer-oriented documents. Within this information, you will find a description of the services that FCA US LLC offers to its customers as well as the details of the terms and conditions for maintaining its validity. Please take the time to read all of these publications carefully before driving your vehicle for the first time. Following the instructions, recommendations, tips, and important warnings in this manual will help ensure safe and enjoyable operation of your vehicle.

This Owner's Manual describes all versions of this vehicle. Options and equipment dedicated to specific markets or versions are not expressly indicated in the text. Therefore, you should only consider the information that is related to the trim level, engine, and version that you have purchased. Any content introduced throughout the Owner's Information, which may or may not be applicable to your vehicle, will be identified with the wording "If Equipped". All data contained in this publication are intended to help you use your vehicle in the best possible way. FCA US LLC aims at a constant improvement of the vehicles produced. For this reason, it reserves the right to make changes to the model described for technical and/or commercial reasons. For further information, contact an authorized dealer.

When it comes to service, remember that authorized dealers know your Ram vehicle best, have factory-trained technicians, genuine Mopar® parts, and care about your satisfaction.

SYMBOLS KEY

WARNING!	These statements apply to operating procedures that could result in a collision, bodily injury and/or death.
CAUTION!	These statements apply to procedures that could result in damage to your vehicle.
NOTE:	A suggestion which will improve installation, operation, and reliability. If not followed, may result in damage.
TIP:	General ideas/solutions/suggestions on easier use of the product or functionality.
 PAGE REFERENCE ARROW	Follow this reference for additional information on a particular feature.
 FOOTNOTE	Supplementary and relevant information pertaining to the topic.

If you do not read the entire Owner's Manual, you may miss important information. Observe all Cautions and Warnings.

VAN CONVERSIONS/CAMPERS

The New Vehicle Limited Warranty does not apply to body modifications or special equipment installed by van conversion/camper manufacturers/body builders. US

residents refer to your Warranty Information book. Canadian residents refer to the "What Is Not Covered" section of the Warranty Information. Such equipment includes video monitors, DVD/Blu-Ray™, heaters, stoves, refrigerators, etc. For warranty coverage and service on these items, contact the applicable manufacturer.

CONSUMER INFORMATION — TRUCK-CAMPER LOADING

This information is provided in fulfillment of the requirement by the United States Government, Department of Transportation, National Highway Traffic Safety Administration, that "every manufacturer of trucks that are capable of accommodating slide-in campers, manufactured on or after April 1, 1973 shall provide... at the time of original purchase to the first person who purchases the truck"... information on Truck Camper Loading.

A slide-in camper document is provided in your vehicle's glove compartment that contains your Vehicle Identification Number, truck model, cargo weight rating, and the forward/rearward limit of a camper. To obtain additional dimensional and technical specifications for your vehicle, please visit <https://www.ramtrucks.com>.

Figure 1 illustrates the dimensions describing the forward and rearward limits of the zone in which the Center of Gravity (CG) of a slide-in camper must be located, to provide satisfactory vehicle handling and to prevent overload of the front and rear axles.

Figure 2 illustrates a proper match between truck and camper.

NOTE:

The camper Center of Gravity falls within the specified zone.

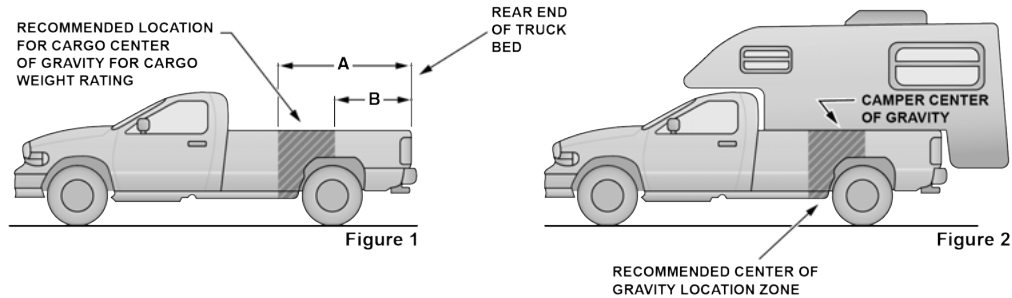

A010500004US

A – Forward Limit of Camper CG
 B – Rearward Limit of Camper CG

When the truck is used to carry a slide-in camper, the total cargo load of the truck consists of the manufacturer's camper weight figure, the weight of installed additional camper equipment not included in the manufacturer's camper weight figure, the weight of camper cargo, and the weight of passengers in the camper. The total cargo load should not exceed the truck's cargo weight rating and the camper's CG should fall within the truck's recommended CG zone when installed.

Secure loose items to prevent weight shifts that could affect the balance of your vehicle. When the truck camper is loaded, drive to a scale and weigh the front and rear wheels separately, to determine axle loads. Individual axle loads should not

exceed either of the Gross Axle Weight Ratings (GAWR). The total of the axle loads should not exceed the Gross Vehicle Weight Rating (GVWR). If weight ratings are exceeded, move or remove items to get the total weight below the ratings.

NOTE:

These ratings are also provided on the Vehicle Certification Label located on the driver's side B-pillar. See ⇨ page 205 for more information.

For any additional instructions, please contact your conversion/camper manufacturer or an authorized dealer.

VEHICLE MODIFICATIONS/ALTERATIONS

WARNING!



Any modifications or alterations to this vehicle could seriously affect its roadworthiness and safety and may lead to a collision resulting in serious injury or death.









SYMBOL GLOSSARY





Some car components have colored labels with symbols indicating precautions to be observed when using this component. It is important to follow all warnings when operating your vehicle. See below for the definition of each symbol → page 126.



NOTE:









Warning and Indicator lights are different based upon equipment options and current vehicle status. Some telltales are optional and may not appear.







Red Warning Lights	
	Air Bag Warning Light → page 126
	Battery Charge Warning Light → page 127
	Brake Warning Light → page 127









Red Warning Lights	
	Door Open Warning Light → page 127
	Electronic Throttle Control (ETC) Warning Light → page 127
	Electric Power Steering (EPS) Fault Warning Light → page 127
	Engine Coolant Temperature Warning Light → page 128
	Hood Open Warning Light → page 128
	Oil Pressure Warning Light → page 128
	Oil Temperature Warning Light → page 128
	Seat Belt Reminder Warning Light → page 128









Red Warning Lights	
	Tailgate Open Warning Light ⇒ page 128
	Trailer Brake Disconnected Warning Light ⇒ page 128
	Transmission Temperature Warning Light ⇒ page 128
	Vehicle Security Warning Light ⇒ page 129









Yellow Warning Lights	
	Adaptive Cruise Control (ACC) Fault Warning Light ⇒ page 129
	Active Driving Assist Fault Warning Light ⇒ page 129
	Air Suspension Fault Warning Light ⇒ page 129







Yellow Warning Lights	
	Anti-Lock Brake System (ABS) Warning Light ⇒ page 129
	Cruise Control Fault Warning Light ⇒ page 131
	Electric Park Brake Warning Light ⇒ page 129
	Electronic Stability Control (ESC) Active Warning Light ⇒ page 129
	Electronic Stability Control (ESC) OFF Warning Light ⇒ page 130
	Engine Check/Malfunction Indicator Warning Light (MIL) ⇒ page 130
	Fuel Level Sensor Failure Warning Light ⇒ page 130
	Low Washer Fluid Warning Light ⇒ page 130







Yellow Warning Lights	
	Low Fuel Warning Light ⇒ page 130
	Rear Axle Locker Fault Warning Light ⇒ page 130
	Service Forward Collision Warning (FCW) Light ⇒ page 130
	Service Stop/Start System Warning Light ⇒ page 130
	Service 4WD Warning Light ⇒ page 131
	Tire Pressure Monitoring System (TPMS) Warning Light ⇒ page 131
Yellow Indicator Lights	
	Air Suspension Payload Protection Indicator Light ⇒ page 132

Yellow Indicator Lights	
	Air Suspension Off-Road 1 Indicator Light ⇒ page 132
	Air Suspension Off-Road 2 Indicator Light ⇒ page 132
	Air Suspension Normal Height Indicator Light ⇒ page 132
	Air Suspension Aerodynamic Height Indicator Light ⇒ page 132
	Air Suspension Ride Height Raising Indicator Light ⇒ page 132
	Air Suspension Ride Height Lowering Indicator Light ⇒ page 132
	Cargo Light Active Indicator Light ⇒ page 132
	Entry/Exit Indicator Light ⇒ page 132

Yellow Indicator Lights	
	Forward Collision Warning (FCW) Off Indicator Light ⇒ page 132
	NEUTRAL Indicator Light ⇒ page 132
	Trailer Merge Assist Indicator Light ⇒ page 133
	TOW/HAUL Indicator Light ⇒ page 133
	Rear Axle Lock Indicator Light ⇒ page 132
	4WD Indicator Light ⇒ page 133
	4WD Low Indicator Light ⇒ page 133
	4WD High Indicator Light ⇒ page 133

Green Indicator Lights	
	Adaptive Cruise Control (ACC) Set With Target Indicator Light ⇒ page 133
	Adaptive Cruise Control (ACC) Set With No Target Detected Indicator Light ⇒ page 133
	Cruise Control SET Indicator Light ⇒ page 133
	ECO Mode Indicator Light ⇒ page 133
	Front Fog Indicator Light ⇒ page 133
	Parking/Headlights On Indicator Light ⇒ page 133
	Stop/Start Active Indicator Light ⇒ page 133
	Turn Signal Indicator Lights ⇒ page 133

Green Indicator Lights	
	4WD AUTO Indicator Light ⇒ page 134
White Indicator Lights	
	Adaptive Cruise Control (ACC) Ready Indicator Light ⇒ page 134
	Cruise Control Ready Indicator Light ⇒ page 134
	Cruise Control SET Indicator Light ⇒ page 134
	Selec-Speed Control (SSC) Indicator Light ⇒ page 134
	Baja Mode Indicator Light ⇒ page 134
	Custom Mode Indicator Light ⇒ page 134

White Indicator Lights	
	Mud/Sand Mode Indicator Light ⇒ page 134
	Rock Mode Indicator Light ⇒ page 134
	Snow Mode Indicator Light ⇒ page 134
	Sport Mode Indicator Light ⇒ page 134
	Tow Mode Indicator Light ⇒ page 134
	Valet Mode Indicator Light ⇒ page 134
Blue Indicator Lights	
	High Beam Indicator Light ⇒ page 134

GETTING TO KNOW YOUR VEHICLE

DIGITAL KEY — IF EQUIPPED

OWNER DIGITAL KEY PAIRING

Your vehicle may be equipped with the ability to use your iPhone® as a Digital Key to lock/unlock and start the vehicle → page 422. To enable this feature, complete the following steps:

Owner Digital Key Pairing Procedure:

1. Ensure your vehicle has been enrolled in Ram Connect and you have created your Owner Account (same credentials used to access your Ram app).
2. Once successfully enrolled with the Ram App, navigate to the home screen and look for the Digital Key menu. This can be found either by swiping left through the tile carousel or by tapping the access tile on the home screen. To begin the owner key pairing process, tap "Start Pairing" or "Continue to Wallet" depending on the version of App in use. Please note that the tile will not be populated until the terms of service and privacy policy have been accepted.
3. Navigate to the Digital Key App in the Uconnect vehicle audio system.
4. Select "Add Owner Key".
5. Follow the prompts in your iPhone® wallet to continue the owner Digital Key pairing process.

6. To pair an iPhone® as your digital key, hold the iPhone® with its NFC antenna against the NFC reader on the vehicle's wireless charging pad until the key is paired successfully.

The Uconnect system will display a success pop-up once the owner key pairing is complete.

Using Your Digital Key

Tap Access

Available on compatible iPhone®s without UWB (ultra-wide band) hardware.

- To unlock the vehicle, tap the iPhone® against the door handle
- To start the vehicle, tap the iPhone® with its NFC antenna against the NFC wireless charger. Then, press the brake pedal and the Start button.

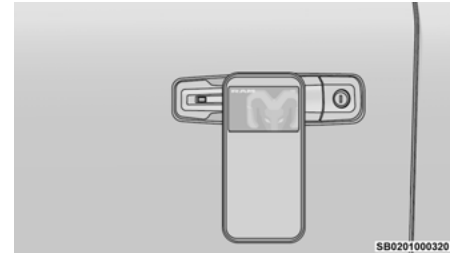

Digital Key On Door Handle

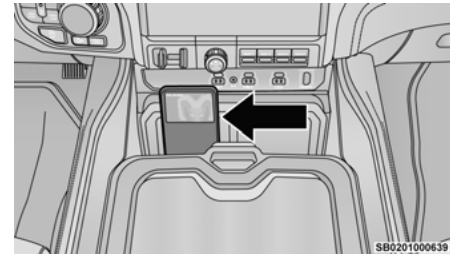

Digital Key On Wireless Charging Pad (NFC Side)

Hands-free Access



Available on compatible iPhone®s with UWB (ultra-wide band) hardware.

- To unlock the vehicle, pull the door handle while carrying your iPhone®.
- To start the vehicle, press the brake pedal and the Start button together while carrying your iPhone®.

In the event that the vehicle does not unlock on grabbing the door handle, move the iPhone® closer to the door handle.

NOTE:

- In order to use Digital Key, the iPhone® must meet certain hardware and software requirements. Please check with your iPhone® manufacturer for regional compatibility requirements and feature availability.

-  **NFC Icon.** To use NFC functionality within the cabin for owner key pairing and vehicle start, ensure the NFC antenna of the iPhone® is placed against the wireless charger  page 76 with the NFC icon.

- For additional safety, it is recommended that you carry the back-up NFC card with you at all times to cover instances such as loss of phone or phone which requires its battery to be charged.
- In case your iPhone® powers off due to lack of charge, the Digital Key will still function for NFC tap access. This power reserve functionality is available for up to 5 hours after the device has powered off. Please note that this feature will not be available if the phone has been manually turned off by the user.
- For any service related activities, users are required to carry along and hand over physical keys to the service dealer.

- If the vehicle detects a key (digital or physical) in the cabin, the doors will not lock. Please check for presence of Digital Keys or key fobs in the cabin.
- Hands-free access for the digital key may be temporarily suspended if the digital key has been present in the vicinity of the doors for an extended period of time.

Key Sharing

As the owner you have the ability to share Digital Keys with iPhone® users. To share a Digital Key complete the following steps:

Sharing A Digital Key

1. Beginning with the owner's iPhone®, navigate to device wallet and select the Digital Key.
2. Locate the sharing icon to select the phone contact you wish to share the Digital Key with.
3. To continue, select the type of access to be provided with the Digital Key (sharing options could include full access or unlock only).
4. It is recommended you share keys with an activation code for maximum security.

Once Digital Key options have been selected and sent to shared contact, they cannot be edited unless access is revoked and re-shared.

Receiving A Digital Key

1. Upon receiving a Digital Key invitation message from the owner, click the message link to proceed.
2. Input activation code from vehicle owner.
3. Digital Key will now be added to your wallet.

NOTE:

In certain instances, the vehicle systems may require additional time to respond to a shared digital key unlock request (e.g. a newly created key approaches the vehicle for the first time).

Key Deletion

iPhone® Procedure Procedure:

1. Navigate to your iPhone® wallet.
2. Tap the Digital Key and proceed to remove the key by using the menu option provided.

Uconnect System Procedure:

1. Within the App drawer, select "Digital Key App".
2. Select which phone you wish to remove by tapping the delete button provided.
3. The owner iPhone® will show a delete authorization pop-up to confirm that it is safe to delete the key. Selecting "Approve" in the pop-up will confirm key deletion and selecting "Deny" will prevent the key from being deleted via the vehicle Uconnect system. Before approving deletion of a digital key, owners must ensure users are not left stranded without a key.

NOTE:

Owners should delete all paired digital keys from the vehicle at the end of ownership. Deleting the connected vehicle APP or the resetting the Uconnect system to factory will not delete paired digital keys. Users are required to delete keys as per the process mentioned above or by reaching out to the call center to perform a 'Return to New' process which will delete all associated connected vehicle information from the cloud servers and delete all owner and shared digital keys.

KEYS

KEY FOB

Your vehicle is equipped with a key fob, or Digital Key (if equipped) which supports Passive Entry, Remote Keyless Entry (RKE), Keyless Enter 'n Go™ (if equipped), remote air suspension lowering (if equipped), and Remote Start (if equipped). The key fob allows you to lock or unlock all doors, tailgate, and the RamBox (if equipped) as well as activate the Panic Alarm from distances up to approximately 66 ft (20 m). The key fob does not need to be pointed at the vehicle to activate the system. The key fob also contains an emergency key, which is stored in the rear of the key fob.

NOTE:

- The key fob's wireless signal may be blocked if the key fob is located next to a mobile phone, laptop, or other electronic device. This may result in poor performance.
- If your vehicle is equipped with a Wireless Charging Pad, the key fob may not be detected if it is placed within 6 inches (15 cm) of the pad ➞ page 76.
- With the ignition in the ON position and the vehicle moving at 2 mph (4 km/h), all RKE commands are disabled.

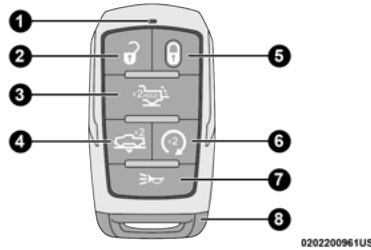

Key Fob

- 1 – LED Indicator Light
- 2 – Unlock
- 3 – Tailgate Lowering (If Equipped)
- 4 – Air Suspension Remote Lowering (If Equipped)
- 5 – Lock
- 6 – Remote Start (If Equipped)
- 7 – Panic
- 8 – Emergency Key

In case the ignition switch does not change with the push of a button, the key fob may have a low or fully depleted battery. A low key fob battery can be verified by referring to the instrument cluster display, which will display a procedure to follow.

NOTE:

A low key fob battery condition may be indicated by a message in the instrument cluster display, or by the LED light on the key fob. If the LED key fob light no longer illuminates from key fob button pushes, then the key fob battery requires replacement ➞ page 422.

To Lock/Unlock The Doors And Tailgate

All doors, liftgate, and RamBox (if equipped) can be programmed to either unlock on the first push of the unlock button, or for the first push to unlock only the driver's door, then twice within five seconds to unlock all doors, liftgate, and RamBox (if equipped). To lock all the doors, liftgate, and RamBox (if equipped), push the lock button once.

When the doors are unlocked, the turn signals will flash and the illuminated entry system will be activated. When the doors are locked, the turn signals will flash and the horn will chirp.

The horn chirp when the lock button is pushed can be programmed on/off within Uconnect Settings ➞ page 227.

Using The Panic Feature

To turn the Panic feature on or off, push the Panic button on the key fob. When the Panic feature is activated, the turn signals will flash, the horn may pulse on and off (if equipped with horn alarm), and the interior lights will turn on.

The Panic feature will stay on for three minutes unless you turn it off by either pushing the Panic button a second time or driving the vehicle at a speed of 15 mph (24 km/h) or greater.

NOTE:

- The interior lights will turn off if you place the vehicle in the ON/RUN position while the Panic feature is activated. However, the exterior lights and horn (if equipped with horn alarm) will remain on.

- You may need to be less than 35 ft (11 m) from the vehicle when using the key fob to turn off the Panic feature due to the radio frequency noises emitted by the system.

Key Left Vehicle Feature

If a valid key fob is no longer detected inside the vehicle while the vehicle's ignition system is in the ON/RUN or START position, the message "Key Fob Has Left The Vehicle" will be shown in the instrument cluster display along with an interior chime. An exterior audible and visual alert will also be activated to warn the driver.

The vehicle's horn will rapidly chirp three times along with a single flash of the vehicle's exterior lights.

NOTE:

- The doors have to be open and then closed in order for the vehicle to detect a key fob. The Key Left Vehicle feature will activate when the first door is closed and no key fob is detected in the vehicle. If the warning has been activated, and the other doors are closed, no other warnings will be issued.
- These alerts will not be activated in situations where either the vehicle's engine is left running with the key fob inside, or the key fob's wireless signals are blocked.

Air Suspension (Remote Lowering Of The Vehicle)



For easy entry and loading, your vehicle can be lowered by pushing the key fob air suspension lowering button two times. When air suspension lowering is requested using the key fob, the vehicle will send a series of

chirps and flashes to alert the customer that the operation has begun and will continue these alerts until it successfully lowers.

The following conditions must be met for the vehicle to lower remotely:

- The vehicle must not already be in Entry/Exit ride height.
- The vehicle battery must be fully charged.
- All doors must be closed.
- The key fob must be out of the vehicle.
- Gear selector must be in PARK.

NOTE:

Ensure the vehicle is clear of all objects, pets, and people prior to remote lowering.

Canceling Remote Lowering

Vehicle lowering can be canceled at anytime. When vehicle lowering is canceled, the vehicle will raise to the next defined level and lock out the remote lowering feature for five seconds until a new request is made.

To cancel vehicle lowering, push the key fob air suspension lowering button one time during the lowering process. When vehicle lowering is canceled, the horn will chirp two times and the turn signal lamps will flash four times. Once raising is completed, the horn will chirp one time.

NOTE:

More information on air suspension is provided later in this manual, see  page 157.

Replacing The Battery In The Key Fob

The replacement battery model is one CR2450 battery.

NOTE:

- Customers are recommended to use a battery obtained from Mopar®. Aftermarket coin battery dimensions may not meet the original OEM coin battery dimensions.
 - Perchlorate Material — special handling may apply. See www.dtsc.ca.gov/hazardouswaste/perchlorate for further information.
 - Do not touch the battery terminals that are on the back housing or the printed circuit board.
 - Do not replace the coin battery if the LED on the key fob above the top row buttons blinks when a button is pressed. The coin battery should last a minimum of three years with normal vehicle usage.
- Remove the emergency key (1) by pushing the emergency key release button (2) on the side of the key fob, and pulling the emergency key out with your other hand.

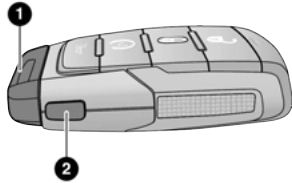

A0204000040US

Emergency Key Removal

- 1 — Emergency Key
2 — Emergency Key Release Button

- Hold the key fob with the button side facing down, and locate the small rectangular gap on the left side between the housing and the back cover of the key fob. Use a small screwdriver (or similar tool) to pry open the left side of the fob cover while applying pressure until the cover snaps open.
- Next, locate the gap on the right side of the key fob, which is positioned farther to the edge than the left side gap. Pry open the right side, and remove the back cover.
- Remove the battery by using your thumb to slide the battery downward and back toward the key ring.

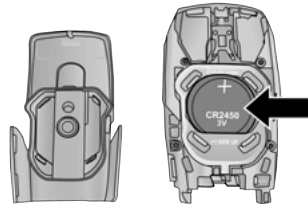

A0204000085US

Key Fob Battery Location

NOTE:

When replacing the battery, ensure the (+) sign on the battery is facing upward. Avoid touching the new battery with your fingers. Skin oils may cause battery deterioration. If you touch a battery, clean it with rubbing alcohol.

- Replace the battery by using your thumb to push down and slide the battery under the small lip on the top edge of the opening.

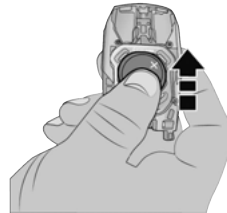

A0204000043US

Key Fob Battery Replacement

- To assemble the key fob case, line up the top edge of the back cover with the top of the fob, and press the edges into the interlocking hinges until all edges snap together with no large visual gaps.
- Reinsert the emergency key until it locks into place.

NOTE:

The key fob battery should only be replaced by qualified technicians. If the battery requires replacement, see an authorized dealer.

WARNING!

- The integrated key fob contains a coin cell battery. Do not ingest the battery; there is a chemical burn hazard. If the coin cell battery is swallowed, it can cause severe internal burns in just two hours and can lead to death.
- If you think a battery may have been swallowed or placed inside any part of the body, seek immediate medical attention.
- Keep new and used batteries away from children. If the battery compartment does not close securely, stop using the product and keep it away from children.

Programming And Requesting Additional Key Fobs

Programming the key fob may be performed by an authorized dealer.

NOTE:

- Once a key fob is programmed to a vehicle, it cannot be repurposed and reprogrammed to another vehicle.
- Only key fobs that are programmed to the vehicle electronics can be used to start and operate the vehicle.

WARNING!

- Always remove the key fobs from the vehicle and lock all doors when leaving the vehicle unattended.
- For vehicles equipped with Keyless Enter 'n Go™ Ignition, always remember to place the ignition in the OFF position when exiting the vehicle.

Duplication of key fobs may be performed at an authorized dealer. This procedure consists of programming a blank key fob to the vehicle electronics. A blank key fob is one that has never been programmed.

NOTE:

- When having the Sentry Key Immobilizer system serviced, bring all vehicle keys with you to an authorized dealer.
- Emergency keys must be ordered to the correct key cut to match the vehicle locks.
- It is not mandatory to replace the key fob if a new emergency key is needed, and vice versa.

SENTRY KEY

The Sentry Key Immobilizer system prevents unauthorized vehicle operation by disabling the engine. The system does not need to be armed or activated. Operation is automatic, regardless of whether the vehicle is locked or unlocked.

The system uses a key fob, keyless push button ignition and a Radio Frequency (RF) receiver to prevent unauthorized vehicle operation. Therefore, only key fobs that are programmed to the vehicle can be used to start and operate the vehicle. The system cannot reprogram a key fob obtained from another vehicle.

After placing the ignition in the ON/RUN position, the Vehicle Security Light will turn on for three seconds for a bulb check. If the light remains on after the bulb check, it indicates that there is a problem with the electronics. In addition, if the light begins to flash after the bulb check, it indicates that someone attempted to start the engine with an invalid key fob. If a valid key fob is used to start the engine but there is an issue with the vehicle electronics, the engine will start and shut off after two seconds.

If the Vehicle Security Light turns on during normal vehicle operation (vehicle running for longer than 10 seconds), it indicates that there is a fault in the electronics. Should this occur, have the vehicle serviced as soon as possible by an authorized dealer.

CAUTION!

The Sentry Key Immobilizer system is not compatible with some aftermarket Remote Start systems. Use of

(Continued)

CAUTION!

these systems may result in vehicle starting problems and loss of security protection.

All of the key fobs provided with your new vehicle have been programmed to the vehicle electronics → page 422.

NOTE:

A key fob that has not been programmed is also considered an invalid key.

START BUTTON**KEYLESS ENTER 'N GO™ IGNITION**

This feature allows the driver to operate the ignition switch with the push of a button as long as the key fob is in the passenger compartment.

The START/STOP ignition button has several operating modes that are labeled and will illuminate when in position. These modes are OFF, ON/RUN, and START.

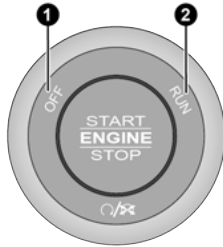

0229200958US

Keyless Push Button Ignition

- 1 – OFF
2 – ON/RUN

The push button ignition can be placed in the following modes:

OFF

- The engine is stopped
- Some electrical devices (e.g. power locks, alarm, etc.) are still available

ON/RUN

- Driving position
- All electrical devices are available (e.g. climate controls, heated seats, etc.)

START

- The engine will start (when foot is on the brake)

NOTE:

If the ignition switch does not change the mode by pushing the button, the key fob may have a low or

depleted battery. In this situation, a backup method can be used to operate the ignition switch. Put the nose side (side opposite of the emergency key) of the key fob against the START/STOP ignition button and push to operate the ignition switch.



0229200962US

Backup Starting Method

WARNING!

- When exiting the vehicle, always remove the key fob from the vehicle and lock your vehicle.
- Never leave children alone in a vehicle, or with access to an unlocked vehicle.
- Allowing children to be in a vehicle unattended is dangerous for a number of reasons. A child or others could be seriously or fatally injured. Children should be warned not to touch the parking brake, brake pedal or the gear selector.
- Do not leave the key fob in or near the vehicle, or in a location accessible to children, and do not leave the Keyless Enter 'n Go™ Ignition in

(Continued)

WARNING!

the ON/RUN position. A child could operate power windows, other controls, or move the vehicle.

- Do not leave children or animals inside parked vehicles in hot weather. Interior heat buildup may cause serious injury or death.

CAUTION!

An unlocked vehicle is an invitation for thieves. Always remove key fob from the vehicle and lock all doors when leaving the vehicle unattended.

NOTE:

- The key fob may not be detected by the vehicle Keyless Enter 'n Go™ system if it is located next to a mobile phone, laptop or other electronic device; these devices may block the key fob's wireless signal and prevent the Keyless Enter 'n Go™ system from starting the vehicle.
- For more information on normal engine starting, see ⇨ page 137.
- When opening the driver's door and the ignition is in the ON/RUN position (engine not running), a chime will sound to remind you to place the ignition in the OFF position. In addition to the chime, the message "Ignition ON" will display in the cluster.

REMOTE START — IF EQUIPPED



This system uses the key fob to start the engine conveniently from outside the vehicle while still maintaining security. The

system has a range of approximately 328 ft (100 m).

Remote Start is used to defrost windows in cold weather and to reach a comfortable climate in all ambient conditions before the customer enters the vehicle.

NOTE:

Obstructions between the vehicle and key fob may reduce this range ➔ page 422.

WARNING!

- Do not start or run an engine in a closed garage or confined area. Exhaust gas contains carbon monoxide which is odorless and colorless. Carbon monoxide is poisonous and can cause serious injury or death when inhaled.
- Keep key fobs away from children. Operation of the Remote Start system, windows, door locks or other controls could cause serious injury or death.

HOW TO USE REMOTE START

Push and release the Remote Start button on the key fob twice within five seconds. The vehicle doors will lock, the parking lights will flash, and the horn will chirp twice (if programmed). Then, the engine will start, and the vehicle will remain in the Remote Start mode for a 15 minute cycle.

Pushing the Remote Start button a third time shuts the engine off.

To drive the vehicle, push the unlock button, and place the ignition in the ON/RUN position.

NOTE:

- With Remote Start, the engine will only run for 15 minutes.
- Remote Start can only be used twice.
- If an engine fault is present or fuel level is low, the vehicle will start and then shut down in 10 seconds.
- The parking lights will turn on and remain on during Remote Start mode.
- Headlight animation (if equipped) will occur when Remote Start is activated, if "Headlight Illumination On Approach" is enabled within Uconnect Settings.
- For security, power window and power sunroof operation (if equipped) are disabled when the vehicle is in the Remote Start mode.
- The ignition must be placed in the ON/RUN position before the Remote Start sequence can be repeated for a third cycle.

All of the following conditions must be met before the engine will remote start:

- Gear selector in PARK
- Doors closed
- Hood closed
- Hazard switch off
- Brake switch inactive (brake pedal not pressed)
- Battery at an acceptable charge level
- Panic button not pushed
- Fuel meets minimum requirement
- System not disabled from previous Remote Start event

- Vehicle Security system not active
- Malfunction Indicator Light (MIL) is not illuminated

WARNING!

- Do not start or run an engine in a closed garage or confined area. Exhaust gas contains carbon monoxide which is odorless and colorless. Carbon monoxide is poisonous and can cause serious injury or death when inhaled.
- Keep key fobs away from children. Operation of the Remote Start system, windows, door locks or other controls could cause serious injury or death.

TO EXIT REMOTE START MODE

To drive the vehicle after a Remote Start, unlock the doors using the key fob or Passive Entry and disarm the Vehicle Security system (if equipped). Then, prior to the end of the 15 minute cycle, press the brake pedal and push and release the START/STOP ignition button.

The Remote Start system will turn the engine off if the Remote Start button on the key fob is pushed again, or if the engine is allowed to run for the entire 15 minute cycle. Once the ignition is placed in the ON/RUN position, the climate controls will resume the previously set operations (temperature, blower control, etc.).

NOTE:

- To avoid unintentional shutdowns, the system will disable for two seconds after receiving a valid Remote Start request.
- For vehicles equipped with the Keyless Enter 'n Go™ — Passive Entry feature, the message "Remote Start Active — Push Start Button" will display in the

instrument cluster display until you push the START/STOP ignition button.

REMOTE START FRONT DEFROST ACTIVATION — IF EQUIPPED

When Remote Start is active, and the outside ambient temperature is 40°F (4.5°C) or below, the system will automatically activate front defrost for 15 minutes or less. The timing is dependent on the ambient temperature. Once the timer expires, the system will automatically adjust the settings depending on ambient conditions. See “Remote Start Comfort Systems — If Equipped” in the next section for detailed operation.

REMOTE START COMFORT SYSTEMS — IF EQUIPPED

When Remote Start is activated, the front and rear defrost will automatically turn on in cold weather conditions. The heated steering wheel and driver heated seat feature will turn on if programmed in the Comfort menu screen within Uconnect Settings  page 227. In warm weather, the driver vented seat feature will automatically turn on when Remote Start is activated, if programmed in the Comfort menu screen. The vehicle will adjust the climate control settings depending on the outside ambient temperature.

NOTE:

If the vehicle is equipped with a rear climate system, it will remain off to allow for optimal front row performance.

Automatic Temperature Control (ATC) — If Equipped

The climate controls will automatically adjust to the optimal temperature and mode setting depending on the outside ambient temperature. This will occur until the ignition is placed in the ON/RUN position where the climate controls will resume their previous settings.

Manual Temperature Control (MTC) — If Equipped

- In ambient temperatures of 40°F (4.5°C) or below, the climate settings will default to maximum heat, with fresh air entering the cabin. If the front defrost timer expires, the vehicle will enter Mix mode.
- In ambient temperatures from 40°F (4.5°C) to 78°F (26°C), the climate settings will be based on the last settings selected by the driver.
- In ambient temperatures of 78°F (26°C) or above, the climate settings will default to MAX A/C, Bi-Level mode, with Recirculation on.

For more information on ATC, MTC, and climate control settings, see  page 60.

NOTE:

These features will stay on through the duration of Remote Start, or until the ignition is placed in the ON/RUN position. The climate control settings will change, and exit the automatic defaults, if manually adjusted by the driver while the vehicle is in Remote Start mode. This includes turning the climate controls off using the OFF button.

REMOTE START WINDSHIELD WIPER DE-ICER ACTIVATION — IF EQUIPPED

When Remote Start is active and the outside ambient temperature is less than 33°F (0.6°C), the Windshield Wiper De-Icer will activate. Exiting Remote Start will resume its previous operation. If the Windshield Wiper De-Icer was active, the timer and operation will continue.

REMOTE START ABORT MESSAGE

One of the following messages will display in the instrument cluster display if the vehicle fails to remote start, or exits Remote Start prematurely:

- Remote Start Canceled — Door Open
- Remote Start Canceled — Hood Open
- Remote Start Canceled — Tailgate Open
- Remote Start Canceled — Fuel Low
- Remote Start Canceled — Time Expired
- Remote Start Canceled — System Fault
- Remote Start Disabled — Start Vehicle to Reset

The instrument cluster display message stays active until the ignition is placed in the ON/RUN position.

VEHICLE SECURITY SYSTEM — IF EQUIPPED

The Vehicle Security system monitors the vehicle doors, hood, tailgate, and the Keyless Enter 'n Go™ Ignition

for unauthorized operation. While the Vehicle Security system is armed, interior switches for door locks and tailgate release are disabled. If something triggers the alarm, the Vehicle Security system will provide the following audible and visible signals:

- The horn will pulse.
- The turn signals will flash.
- The Vehicle Security Light, located in the lower right corner of the instrument cluster display, will flash.

TO ARM THE SYSTEM

Follow these steps to arm the Vehicle Security system:

1. Make sure the vehicle is placed in the OFF position.
 - For vehicles equipped with Keyless Entry, make sure the vehicle is cycled to OFF.
2. Perform one of the following methods to lock the vehicle:
 - Push the lock button on the interior power door lock switch with the driver and/or passenger door open.
 - Push the lock button on the exterior Passive Entry door handle with a valid key fob available in the same exterior zone ➡ page 28.
 - Push the lock button on the key fob.
3. If any doors are open, close them.

TO DISARM THE SYSTEM

The Vehicle Security system can be disarmed using any of the following methods:

- Push the unlock button on the key fob.
- Grab the Passive Entry door handle to unlock the door ➡ page 28.
- Cycle the vehicle out of the OFF position to disarm the system.

NOTE:

- The driver's door key cylinder cannot arm or disarm the Vehicle Security system. Use of the door key cylinder when the system is armed will sound the alarm when the door is opened.
- The Vehicle Security system remains armed when the power tailgate (if equipped) is opened using the tailgate button on the key fob.
- If Passive Entry (if equipped) is used to unlock the tailgate, the Vehicle Security system is disarmed and the rest of the vehicle doors will remain locked unless all doors are set to unlock on first press within Uconnect Settings.
- When the Vehicle Security system is armed, the interior power door lock switches will not unlock the doors.

The Vehicle Security system is designed to protect your vehicle. However, you can create conditions where the system will give you a false alarm. If one of the previously described arming sequences has occurred, the Vehicle Security system will arm regardless of whether you are in the vehicle or not. If you remain

in the vehicle and open a door, the alarm will sound. If this occurs, disarm the Vehicle Security system.

If the Vehicle Security system is armed and the battery becomes disconnected, the Vehicle Security system will remain armed when the battery is reconnected; the exterior lights will flash, and the horn will sound. If this occurs, disarm the Vehicle Security system.

REARMING OF THE SYSTEM

If something triggers the alarm and no action is taken to disarm it, the Vehicle Security system will turn the horn off after a 29 second cycle (with five seconds between cycles and up to eight cycles if the trigger remains active) and then rearm itself.

SECURITY SYSTEM MANUAL OVERRIDE

The Vehicle Security system will not arm if you lock the doors using the manual door lock.

DOORS

MANUAL DOOR LOCKS

The power door locks can be manually locked from inside the vehicle by using the door lock knob. To lock each door, push the door lock knob on each door trim panel downward. To unlock the front doors, pull the inside door handle to the first detent. To unlock the rear doors, pull the door lock knob on the door trim panel upward. If the lock knob is down when the door is closed, the door will lock. Therefore, make sure the key fob is not inside the vehicle before closing the door.

NOTE:

Manually locking the vehicle will not arm the Vehicle Security system.

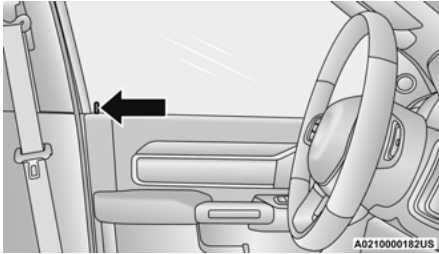

Front Door Lock Knob

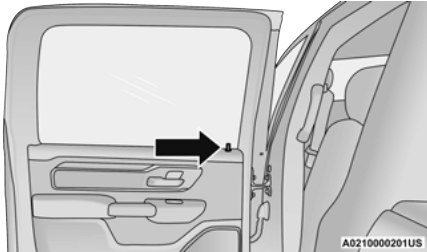

Rear Door Lock Knob

WARNING!

- For personal security and safety in the event of a collision, lock the vehicle doors before you drive as well as when you park and leave the vehicle.
- When exiting the vehicle, always make sure the keyless ignition is in the OFF position, remove the key fob from the vehicle and lock your vehicle.
- Never leave children alone in a vehicle, or with access to an unlocked vehicle. Allowing children to be in a vehicle unattended is dangerous for a number of reasons. A child or others could be seriously or fatally injured. Children should be warned not to touch the parking brake, brake pedal or the gear selector.
- Do not leave the key fob in or near the vehicle, or in a location accessible to children, and do not leave the Keyless Enter 'n Go™ Ignition in the ACC or ON/RUN position. A child could operate power windows, other controls, or move the vehicle.

POWER DOOR LOCKS — IF EQUIPPED

The power door lock switches are located on each front door panel. Push the switch to lock or unlock the doors.

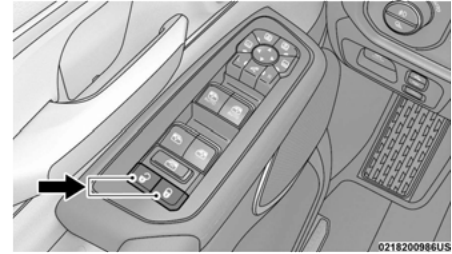

Power Door Lock Switches

The driver's door will unlock automatically if the key fob is detected inside the vehicle when the door lock button on the front door panel is used to lock the door. This will occur for two attempts. Upon the third attempt, the doors will lock even if the key fob is inside.

NOTE:

If the key fob is located next to a mobile phone, laptop, or other electronic device, the wireless signal may get blocked, and the driver's door may not unlock automatically.

If the door lock switch is pushed while the vehicle is in ON/RUN and the driver's door is open, the doors will not lock.

If a rear door is locked, it cannot be opened from inside the vehicle without first unlocking the door. The door may be unlocked manually by raising the lock knob.

POWER SIDE STEPS — IF EQUIPPED

The Power Side Steps will extend a step for easier entry and exit of the vehicle.

When configured for Auto mode, the Power Side Steps will deploy when any of the doors are opened, or when the deploy setting is activated through the touchscreen. When configured for Store mode, the steps will not deploy unless the setting is selected manually through the Controls menu within the touchscreen.

If the vehicle speed exceeds 4 mph (7 km/h), or if the retract setting is selected within Uconnect Settings ➡ page 227, the steps will retract.

KEYLESS ENTER 'n Go™ — PASSIVE ENTRY — IF EQUIPPED

The Passive Entry system is an enhancement to the vehicle's key fob and a feature of Keyless Enter 'n Go™ — Passive Entry. This feature allows you to lock and unlock the vehicle's door(s) without having to push the key fob lock or unlock buttons.

NOTE:

- Passive Entry may be programmed on or off within Uconnect Settings ➡ page 227.
- The key fob may not be detected by the vehicle Passive Entry system if it is located next to a mobile phone, laptop, or other electronic device; these devices may block the key fob's wireless signal and prevent the Passive Entry system from locking/unlocking the vehicle.
- Passive Entry Unlock initiates illuminated approach (low beams, license plate lamp, position lamps) for whichever duration is set between 0, 30, 60 or 90 seconds. Passive Entry Unlock also initiates two flashes of the turn signals.

- If wearing gloves, if it has been raining/snowing, or if there is salt/dirt covering the Passive Entry door handle, the unlock and lock sensitivity can be affected, resulting in a slower response time.
- The doors may unlock and lock when water is sprayed on the Passive Entry door handles, if the key fob is located outside of the vehicle within 5 ft (1.5 m) of the handle.
- If the vehicle is unlocked by Passive Entry and no door is opened within 60 seconds, the vehicle will relock and (if equipped) will arm the Vehicle Security system.

To Unlock From The Driver Or Passenger Side

With a valid Passive Entry key fob within 5 ft (1.5 m) of the door handle, grab the handle to unlock the vehicle. Grabbing the driver's door handle will unlock the driver door automatically. Grabbing the passenger door handle will unlock all doors and the tailgate automatically.

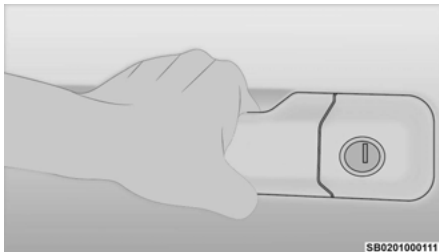

Grab The Door Handle To Unlock

NOTE:

- Either the driver door only or all doors will unlock when you grab hold of the front driver's door handle, depending on the selected setting in the Uconnect system ➡ page 227.
- All doors will unlock when the front passenger door handle is grabbed regardless of the driver's door unlock preference setting.

Frequency Operated Button Integrated Key (FOBIK-Safe)

To minimize the possibility of unintentionally locking a Passive Entry key fob inside your vehicle, the Passive Entry system is equipped with an automatic door unlock feature which will function if the ignition is in the OFF position.

There are five situations that trigger a FOBIK-Safe search in any Passive Entry vehicle:

- A lock request is made by a valid Passive Entry key fob while a door is open.
- A lock request is made by the Passive Entry door handle while a door is open.
- A lock request is made by the door panel switch while the door is open.
- When the Vehicle Security system is in pre-arm or armed status and the tailgate transitions from open to closed.
- When the tailgate transitions from opened to closed and Remote Start is active.

When any of these situations occur, after all open doors are shut, the FOBIK-Safe search will be executed. If it detects a Passive Entry key fob inside the vehicle, the vehicle will unlock and alert the customer.

NOTE:

The vehicle will only unlock the doors when a valid Passive Entry key fob is detected inside the vehicle. The vehicle will not unlock the doors when any of the following conditions are true:

- The doors are manually locked using the door lock knobs.
- Three attempts are made to lock the doors using the door panel switch and then the doors are closed.
- There is a valid Passive Entry key fob outside the vehicle within 5 ft (1.5 m) of a Passive Entry door handle.

To Lock The Vehicle's Doors And Tailgate

With one of the vehicle's Passive Entry key fobs within 5 ft (1.5 m) of either front door handle, touching the Passive Entry lock icon on the door handle will lock the vehicle.

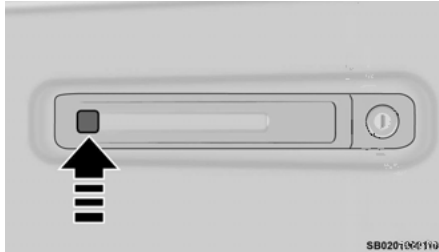

Touch The Door Handle Icon To Lock

NOTE:

DO NOT grab the door handle when touching the lock icon. This could unlock the door(s).

**Do NOT Touch The Lock Icon When Locking****NOTE:**

- After touching the door handle lock icon, you must wait two seconds before you can lock or unlock the doors, using either Passive Entry door handle. This is done to allow you to check if the vehicle is locked by pulling the door handle without the vehicle unlocking.
- If Passive Entry is disabled using the Uconnect Settings, the key fob protection described in "Frequency Operated Button Integrated Key (FOB/IK-Safe)" remains active/functional.
- The Passive Entry system will not operate if the key fob battery is depleted.
 - The LED light on the key fob will not blink if the key fob battery is low or fully depleted, but a low key fob battery condition will still support the Passive Entry system functionality. When the

key fob battery is low, the instrument cluster will display a message indicating that the key fob battery is low → page 422.

AUTOMATIC UNLOCK DOORS ON EXIT — IF EQUIPPED

The doors will unlock automatically on vehicles with power door locks after the following sequence of actions:

1. The Automatic Unlock Doors On Exit feature is enabled within the Uconnect system.
2. All doors are closed.
3. The gear selector was not in PARK, then is placed in PARK.
4. Any door is opened.

AUTOMATIC DOOR LOCKS — IF EQUIPPED

The auto door lock feature default condition is enabled. When enabled, the door locks will lock automatically when the vehicle speed exceeds 15 mph (24 km/h). The auto door lock feature is enabled/disabled in the Uconnect Settings → page 227.

CHILD-PROTECTION DOOR LOCK SYSTEM — REAR DOORS

To provide a safer environment for small children riding in the rear seats, the rear doors are equipped with a Child-Protection Door Lock system.

To use the system, open each rear door, use a flat-blade screwdriver, and rotate the dial to the lock or

unlock position. When the system on a door is engaged, that door can only be opened by using the outside door handle even if the inside door lock is in the unlocked position.

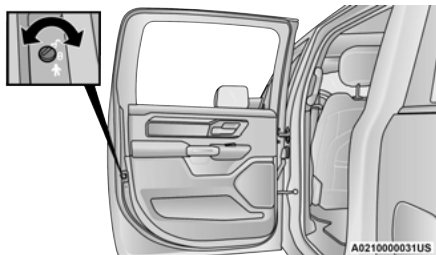

Child Lock Control

NOTE:

- When the Child-Protection Door Lock system is engaged, the door can be opened only by using the outside door handle even though the inside door lock is in the unlocked position.
- After disengaging the Child-Protection Door Lock system, always test the door from the inside to make certain it is in the unlocked position.
- After engaging the Child-Protection Door Lock system, always test the door from the inside to make certain it is in the locked position.
- For emergency exit with the system engaged, pull up on the door lock knob (unlocked position), lower the window, and open the door with the outside door handle.

WARNING!

Avoid trapping anyone in the vehicle in a collision. Remember that the rear doors cannot be opened from the inside door handle when the Child Protection Door Locks are engaged.

NOTE:

Always use this device when carrying children. After engaging the Child-Protection Door Lock system on both rear doors, check for effective engagement by trying to open a door with the internal handle. Once the Child-Protection Door Lock system is engaged, it is impossible to open the doors from inside the vehicle. Before getting out of the vehicle, be sure to check that there is no one left inside.

STEERING WHEEL

TILT/TELESCOPING STEERING COLUMN

This feature allows you to tilt the steering column upward or downward. It also allows you to lengthen or shorten the steering column. The tilt/telescoping lever is located on the steering column, below the multifunction lever.



Tilt/Telescoping Lever

To unlock the steering column, push the control downward (toward the floor). To tilt the steering column, move the steering wheel upward or downward as desired. To lengthen or shorten the steering column, pull the steering wheel outward or push it inward as desired. To lock the steering column in position, push the control upward until fully engaged.

WARNING!

Do not adjust the steering column while driving. Adjusting the steering column while driving or driving with the steering column unlocked, could cause the driver to lose control of the vehicle. Failure to follow this warning may result in serious injury or death.

HEATED STEERING WHEEL — IF EQUIPPED



The steering wheel contains a heating element that helps warm your hands in cold weather. Depending on trim level, the heated steering wheel has one or three

temperature settings. Once the heated steering wheel has been turned on, it will stay on until the operator turns it off. The heated steering wheel may not turn on when it is already warm.

The heated steering wheel control button is located on the left side of the radio screen or within the Uconnect system. You can gain access to the control button on the top left side of the screen by tapping the temperature controls, which will provide a quick drop-down menu containing the controls, or through the Controls menu of the touchscreen. If your vehicle is not equipped with the button on the side of the radio, you can also access the control button through the Climate menu.

One Temperature Setting:

- Press the heated steering wheel button once to turn the heating element on
- Press the heated steering wheel button a second time to turn the heating element off.

Three Temperature Settings:

- Press the heated steering wheel button once to turn the HI setting on.
- Press the heated steering wheel button a second time to turn the MED setting on.
- Press the heated steering wheel button a third time to turn the LO setting on.
- Press the heated steering wheel button a fourth time to turn the heating elements off.

NOTE:

The engine must be running for the heated steering wheel to operate.

For information on use with the Remote Start system, see ⇨ page 25.

WARNING!

- Persons who are unable to feel pain to the skin because of advanced age, chronic illness, diabetes, spinal cord injury, medication, alcohol use, exhaustion, or other physical conditions must exercise care when using the steering wheel heater. It may cause burns even at low temperatures, especially if used for long periods.
- Do not place anything on the steering wheel that insulates against heat, such as a blanket or steering wheel covers of any type or material. This may cause the steering wheel heater to overheat.

DRIVER MEMORY SETTINGS — IF EQUIPPED

This feature allows the driver to save up to two different memory profiles for easy recall through a memory switch. Each memory profile saves desired position settings for the following features:

- Driver's seat position
- Easy Entry/Exit seat operation (if equipped)
- Power adjustable pedals (if equipped)
- Side mirrors
- A set of desired radio station presets

NOTE:

Your vehicle is equipped with two key fobs, each can be linked to either memory position 1 or 2.

The memory settings switches are located on the front door panels, next to the door handle, and consists of two or three buttons, depending on trim level:

- The seat massage button (three button configuration only), which is used to activate the massage function.
- The (1) and (2) buttons which are used to recall either of two saved memory profiles.

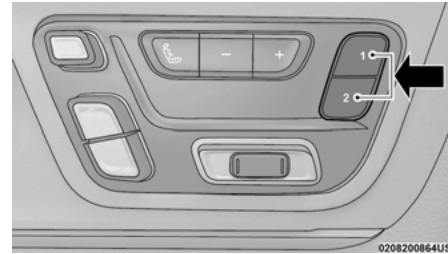

Memory Settings Switch

PROGRAMMING THE MEMORY FEATURE

To create a new memory profile, perform the following:

NOTE:

Saving a new memory profile will erase the selected profile from memory.

1. Place the vehicle in the ON/RUN position (do not start the vehicle).
2. Adjust all memory profile settings to desired preferences (i.e., driver's seat, outside mirrors, adjustable pedals (if equipped), and radio station presets).
3. Push the the desired memory button (1 or 2) within five seconds. The instrument cluster display will display which memory position has been set.

NOTE:

Memory profiles can be set without the vehicle in PARK, but the vehicle must be in PARK to recall a memory profile.

LINKING AND UNLINKING THE KEY FOB TO MEMORY

Your key fob can be programmed to recall one of two saved memory profiles.

NOTE:

Before programming your key fob you must select the "Personal Settings Linked to Key Fob" feature through the Uconnect system ➡ page 227.

To program your key fob, perform the following:

1. Place the vehicle's ignition in the OFF position.
2. Select a desired memory profile 1 or 2.
3. Once the profile has been recalled, push and release button (1) or (2) accordingly. "Memory Profile Set" (1 or 2) will display in the instrument cluster.
4. Push and release the lock button on the key fob within 10 seconds.

NOTE:

Your key fob can be unlinked from your memory settings by pushing and holding either memory profile 1 or 2, followed by pushing the unlock button on the key fob within 10 seconds.

MEMORY POSITION RECALL

NOTE:

If a recall is attempted when the vehicle is not in PARK, a message will display in the instrument cluster display.

To recall the memory settings for driver one or two, push the desired memory button number (1 or 2) or the unlock button on the key fob linked to the desired memory position.

A recall can be canceled by pushing any of the memory buttons (1 or 2) during a recall. When a recall is canceled, the driver seat will stop moving. A delay of one second will occur before another recall can be selected.

SEATS

Seats are a part of the Occupant Restraint system of the vehicle.

WARNING!

- It is dangerous to ride in a cargo area, inside or outside of a vehicle. In a collision, people riding in these areas are more likely to be seriously injured or killed.

(Continued)

WARNING!

- Do not allow people to ride in any area of your vehicle that is not equipped with seats and seat belts. In a collision, people riding in these areas are more likely to be seriously injured or killed.
- Be sure everyone in your vehicle is in a seat and using a seat belt properly.

MANUAL ADJUSTMENT FRONT SEATS — IF EQUIPPED

WARNING!

- Adjusting a seat while the vehicle is moving is dangerous. The sudden movement of the seat could cause you to lose control. The seat belt might not be adjusted properly and you could be injured. Adjust the seat only while the vehicle is parked.
- Do not ride with the seatback reclined so that the shoulder belt is no longer resting against your chest. In a collision you could slide under the seat belt and be seriously or even fatally injured. Use the recliner only when the vehicle is parked.

Manual Front Seat Forward/Rearward Adjustment

Both front seats are adjustable forward or rearward. The manual seat adjustment handle is located under the seat cushion at the front edge of each seat.

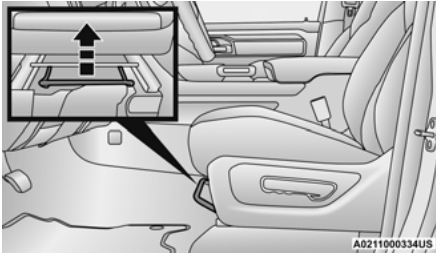

Manual Seat Adjustment Bar

While sitting in the seat, pull up on the handle and slide the seat forward or rearward. Release the bar once you have reached the desired position. Then, using body pressure, move forward and rearward on the seat to be sure that the seat adjusters have latched.

WARNING!

- Adjusting a seat while driving may be dangerous. Moving a seat while driving could result in loss of control which could cause a collision and serious injury or death.
- Seats should be adjusted before fastening the seat belts and while the vehicle is parked. Serious injury or death could result from a poorly adjusted seat belt.

Manual Front Seat Recline Adjustment

The recline lever is located on the outboard side of the seat. To recline the seat, lean forward slightly, lift the lever, lean back to the desired position and release

the lever. To return the seatback to its normal upright position, lean forward and lift the lever. Release the lever once the seatback is in the upright position.

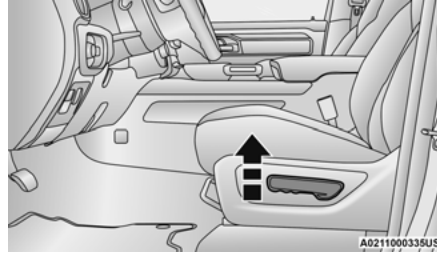

Manual Recline Lever

WARNING!

- Do not stand or lean in front of the seat while actuating the handle. The seatback may swing forward and hit you causing injury.
- To avoid injury, place your hand on the seatback and actuate the handle, then position the seatback in the desired position.

Front Bench Seat — If Equipped

The seat is divided into three segments. The outboard seat portions are each 40% of the total width of the seat. If equipped, the back of the center portion (20%) easily folds down to provide an armrest/center storage compartment.

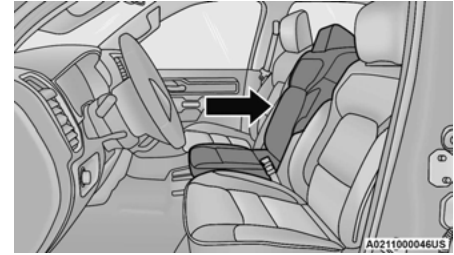

Center Portion Of Front Bench Seat



Center Portion Folded Forward

MANUAL ADJUSTMENT REAR SEATS

WARNING!

Do not place luggage or cargo higher than the top of the seatback. This could impair visibility or become a dangerous projectile in a sudden stop or collision.

Reclining Rear Seats — If Equipped

The recliner handle is located on the front of the rear outboard seat cushions. To adjust the seatback, lift upward on the handle, and slide the seat bottom forward. The lower portion of the seatback will tilt rearward. When you reach the desired position, release the handle.

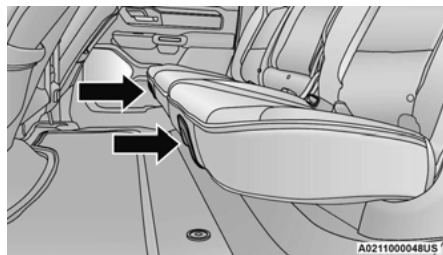

Rear Seat Recliner Handle Locations

NOTE:

This feature is not available if vehicle is equipped with rear bench seat.

WARNING!

Do not ride with the seatback reclined so that the shoulder belt is no longer resting against your chest. In a collision you could slide under the seat belt, which could result in serious injury or death.

Second Row 60/40 Folding Seat

To provide additional storage area, each rear seat can be folded up. This allows for extended cargo space, and can still maintain some rear seating room if needed.

Lift upward on one, or both portions of the seat cushion until it is flat against the seatback.



Rear Seats Folded

Fold the seat cushion down into its original position by pushing the seat cushion downward into place.

POWER ADJUSTMENT FRONT SEATS — IF EQUIPPED

Some models may be equipped with 8-way or 24-way power driver and passenger seats.

The 8-way power seat switches are located on the outboard side of the driver and passenger seat cushions. There are two power seat switches that are used to control the movement of the seat cushion and the seatback.

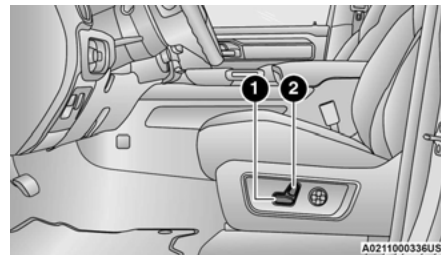

8-way Power Seat Switches

- 1 — Power Seat Switch
- 2 — Power Seatback Switch

The 24-way power seat switches are located on the driver and front passenger door panels near the door handles. These switches control the movement of the seat cushion and the seatback.

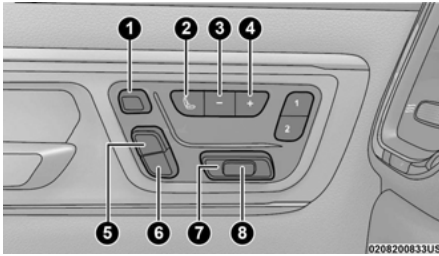

24-way Power Seat Switches

- 1 – Front Headrest Adjustment Switch
- 2 – Power Massage Switch
- 3 – Decrease Back/Thigh Bolster & Lumbar Switch
- 4 – Increase Back/Thigh Bolster & Lumbar Switch
- 5 – Upper Seatback Switch
- 6 – Seatback Recline Switch
- 7 – Seat Switch (Multiple Functions)
- 8 – Cushion Extender Switch

Adjusting The Seat Forward Or Rearward

The seat can be adjusted both forward and rearward by using the power seat switch. The seat will move in the direction of the switch. Release the switch when the desired position has been reached.

Adjusting The Seat Up Or Down

The height of the seats can be adjusted up or down by using the power seat switch. The seat will move in the direction of the switch. Release the switch when the desired position has been reached.

Tilting The Seat Up Or Down

The angle of the seat cushion can be adjusted up or down using the power seat switch. The front of the seat cushion will move in the direction of the switch. Release the switch when the desired position has been reached.

Reclining The Seatback

The angle of the seatback can be adjusted forward or rearward by using the power seat switch. The seat will move in the direction of the switch. Release the switch when the desired position is reached.

WARNING!

- Adjusting a seat while driving may be dangerous. Moving a seat while driving could result in loss of control which could cause a collision and serious injury or death.
- Seats should be adjusted before fastening the seat belts and while the vehicle is parked. Serious injury or death could result from a poorly adjusted seat belt.
- Do not ride with the seatback reclined so that the shoulder belt is no longer resting against your chest. In a collision you could slide under the seat belt, which could result in serious injury or death.

CAUTION!

Do not place any article under a power seat or impede its ability to move as it may cause damage to the seat controls. Seat travel may become limited if movement is stopped by an obstruction in the seat's path.

Power Lumbar – If Equipped

Vehicles equipped with power driver or passenger seats may also be equipped with a 2-way or a 4-way power lumbar adjustment. The power lumbar switch is located on the outboard side of the power seat or on the door panel, depending on trim level. Push the switch forward to increase the lumbar support. Push the switch rearward to decrease the lumbar support. If equipped with a 4-way adjustment, pushing upward or downward on the switch will raise and lower the position of the support.

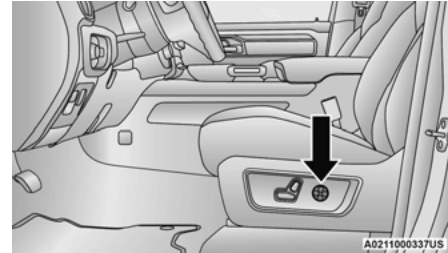

Outboard Side Power Lumbar Switch

The 24-way power seat adjustment lumbar switches that are located on the door trim. The (+) and (-) switches can be used to adjust lumbar support in/out and up/down. The power lumbar can also be adjusted directly in the Uconnect display.

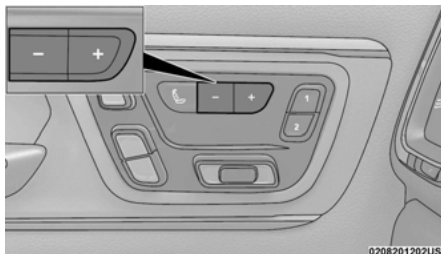

Door Trim Power Lumbar Adjustment Switch

Easy Entry/Exit Seat — If Equipped

This feature provides automatic driver's seat positioning to enhance driver mobility when entering and exiting the vehicle.

The distance the driver's seat moves depends on where you have the driver's seat positioned when you place the vehicle's ignition in the OFF position.

- When you place the vehicle's ignition in the OFF position, the driver's seat will move about 2.4 inches (6 cm) rearward if the driver's seat position is greater than or equal to 2.7 inches (6.77 cm) forward of the rear stop. The seat will return to its previously set position when you place the ignition into the ON/RUN position.
- When you remove the key fob from the ignition, the driver's seat will move to a position 0.3 inches (0.77 cm) forward of the rear stop if the driver's seat position is between 0.9 inches and 2.7 inches (2.27 cm and 6.77 cm) forward of the rear stop. The seat

will return to its previously set position when you place the ignition to the ON/RUN position.

- The Easy Entry/Easy Exit feature is disabled when the driver's seat position is less than 0.9 inches (2.27 cm) forward of the rear stop. At this position, there is no benefit to the driver by moving the seat for Easy Exit or Easy Entry.

When enabled in Uconnect Settings, Easy Entry and Easy Exit positions are stored in each memory setting profile → page 31.

NOTE:

The Easy Entry/Exit feature is enabled or disabled through the programmable features in the Uconnect system → page 227.

POWER SEAT MESSAGE — IF EQUIPPED

In some models, the driver's and front passenger's seats may be equipped with power massage.

The seat massage feature can be turned on/off through the massage button located on the door panel near the handle, or through the Comfort menu on the radio screen.

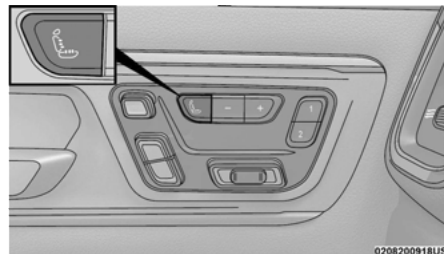

Door Panel Massage Button (Driver's Side)

Once activated by either method, the massage controls screen can be viewed on the Uconnect display. "Massage Type" and "Intensity Level" can be selected for the activated seat.

There are four intensity levels and five massage types that can be selected.

Intensity Levels:

- High
- Med
- Low
- Off

Massage Types:

- Waterfall
- Lower Back
- Extend
- Low Extend
- Shoulder

The massage type and intensity level status will be synchronized between the main Uconnect display and through the massage button located on the door panel.

The selected settings will save in the system's memory when turned off, and will resume the next time the system is turned on.

NOTE:

- For vehicles equipped with a selectable back/cushion feature for massage seats, the massage feature can be deselected for either the seatback or seat cushion. If both options are deselected, massage will turn off.
- The vehicle must be running for the power seatback massage to operate.
- The massage feature will turn off after 20 minutes of use. However, if the massage type or intensity level is changed, the timer then resets.

HEATED SEATS — IF EQUIPPED

WARNING!

- Persons who are unable to feel pain to the skin because of advanced age, chronic illness, diabetes, spinal cord injury, medication, alcohol use, exhaustion or other physical condition must exercise care when using the seat heater. It may cause burns even at low temperatures, especially if used for long periods of time.
- Do not place anything on the seat or seatback that insulates against heat, such as a blanket

(Continued)

WARNING!

or cushion. This may cause the seat heater to overheat. Sitting in a seat that has been overheated could cause serious burns due to the increased surface temperature of the seat.

Front Heated Seats — If Equipped



The heated seat control buttons are located on the center stack below the radio screen, or within the Uconnect system.

- Press the heated seat button once to turn the HI setting on.
- Press the heated seat button a second time to turn the MED setting on.
- Press the heated seat button a third time to turn the LO setting on.
- Press the heated seat button a fourth time to turn the heating elements off.

NOTE:

- Once a heat setting is selected, heat will be felt within two to five minutes.
- The engine must be running for the heated seats to operate.
- The level of heat selected will stay on until the operator changes it.

For information on use with the Remote Start system, see  page 25.

Rear Heated Seats — If Equipped



On some models, the two rear outboard seats may be equipped with heated seats. There are two heated seat switches that allow the rear passengers to operate the seats independently. The heated seat switches for each heater are located on the rear of the center console.

You can choose from HI, MED, LO, or OFF heat settings. Indicator lights in each switch indicate the level of heat in use.

- Push the heated seat button once to turn the HI setting on.
- Push the heated seat button a second time to turn the MED setting on.
- Push the heated seat button a third time to turn the LO setting on.
- Push the heated seat button a fourth time to turn the heating elements off.

NOTE:

The level of heat selected will stay on until the operator changes it.

VENTILATED SEATS — IF EQUIPPED

Front Ventilated Seats



The ventilated seat control buttons are located on the center stack below the radio screen, or within the Uconnect system. The fans operate at three speeds: HI, MED and LO.

- Press the ventilated seat button once to choose HI.
- Press the ventilated seat button a second time to choose MED.
- Press the ventilated seat button a third time to choose LO.
- Press the ventilated seat button a fourth time to turn the ventilation off.

NOTE:

The engine must be running for the ventilated seats to operate.

For information on use with the Remote Start system, see ➔ page 25.

Rear Ventilated Seats — If Equipped

If equipped, the two outboard rear seats will have ventilated seats. The rear ventilated seat control switches are located on the rear of the center console.

The fans operate at three speeds: HI, MED, and LO. Push the ventilated seat buttons to toggle through the speeds, or to turn the feature off.

NOTE:

The vehicle must be running for the ventilated seats to operate.

PLASTIC GROCERY BAG RETAINERS — IF EQUIPPED

Retainer hooks which will hold plastic grocery bag handles are attached to the underside of the rear

seat cushion. To access these hooks, lift the rear seat cushion upward.

HEAD RESTRAINTS

Head restraints are designed to reduce the risk of injury by restricting head movement in the event of a rear impact. Head restraints should be adjusted so that the top of the head restraint is located above the top of your ear.

WARNING!

- All occupants, including the driver, should not operate a vehicle or sit in a vehicle's seat until the head restraints are placed in their proper positions in order to minimize the risk of neck injury in the event of a crash.
- Head restraints should never be adjusted while the vehicle is in motion. Driving a vehicle with the head restraints improperly adjusted or removed could cause serious injury or death in the event of a collision.

NOTE:

Do not reverse the head restraints (making the rear of the head restraint face forward) in an attempt to gain additional clearance to the back of your head.

Front Head Restraints

Your vehicle is equipped with one of two available front four-way driver and passenger head restraints.

Four-Way Head Restraints With Bottom Adjustment Button

To raise the head restraint, pull upward on the head restraint. To lower the head restraint, push the adjustment button, located at the base of the head restraint, and push downward on the head restraint.

NOTE:

The head restraints should only be removed by qualified technicians, for service purposes only. If either of the head restraints require removal, see an authorized dealer.

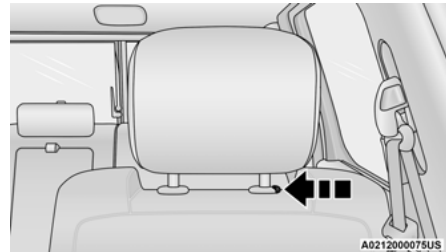
**Head Restraint Adjustment Button Location**

To adjust the head restraint forward, pull the top of the head restraint toward the front of the vehicle as desired and release. To adjust the head restraint rearward, pull the top of the head restraint to the forward most position and release. The head restraint will return to the rear most position.

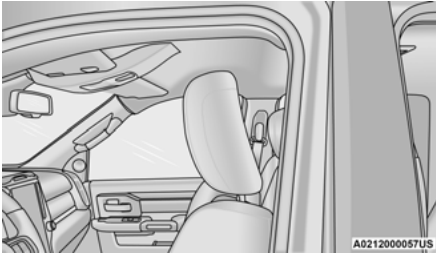

Upright Position



Forward Adjustment

NOTE:

If your vehicle is equipped with a front bench seat, the center head restraint is not adjustable or removable.

Four-Way Head Restraints With Side Adjustment Button

If your vehicle is equipped with manual front head restraints, to raise the head restraint, push the adjustment button, located on the left side of the head

restraint, and pull upward on the head restraint. To lower the head restraint, push the adjustment button, and push downward on the head restraint.

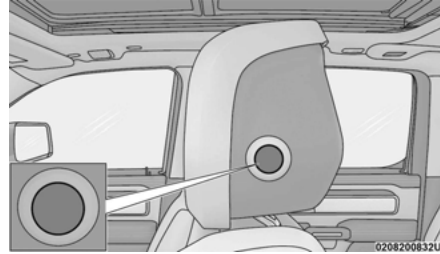
**Manual Head Restraint Adjustment Button**

To adjust the head restraint forward, press the adjustment button on the left side of the head restraint, and pull the top of the head restraint toward the front of the vehicle as desired and release. To adjust the head restraint rearward, press the adjustment button, and push the top of the head restraint toward the rear of the vehicle as desired and release.



Upright Position (Manual Head Restraint)

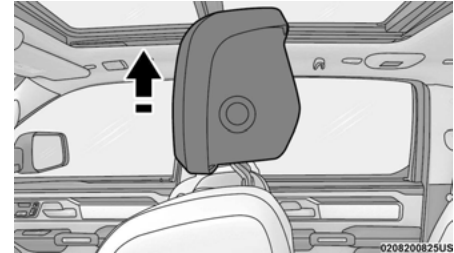

Upward Adjustment (Manual Head Restraint)

Power Four-Way Head Restraints

If your vehicle is equipped with power front head restraints, push upward or push downward on the head restraint adjustment switch, located on the door trim panel, to raise or lower the head restraint. The head restraint will move in the direction of the switch. Release the switch when the desired position has been reached.



Power Four-Way Head Restraint Adjustment Switch

The head restraint can also be adjusted both forward and rearward. Push the head restraint switch forward or rearward. The head restraint will move in the direction of the switch. Release the switch when the desired position has been reached.

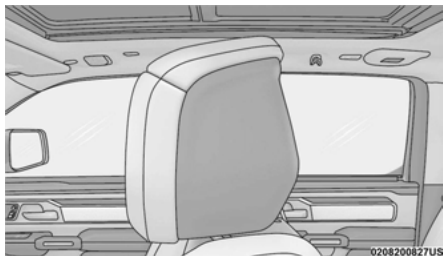

Upright Position (Power Head Restraint)



Forward Adjustment (Power Head Restraint)

The front power head restraints are also equipped with adjustable wings, located on the outer left-hand and right-hand front face of the head restraint.

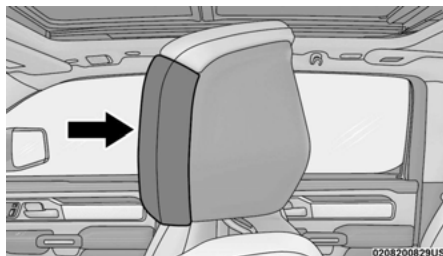

Adjustable Wing (Left-Hand Side Shown)

To adjust the wings for additional comfort and support, pull forward on the wings. To return the wings, push the wings rearward to the flat position.

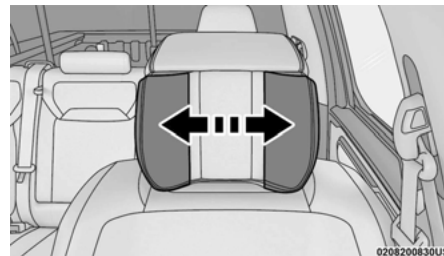

Wing Adjustment

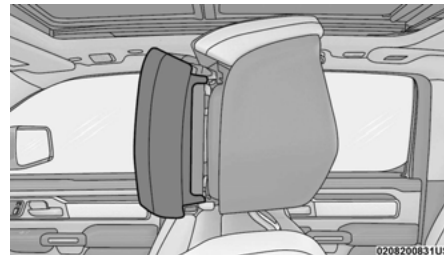

Wing Extended (Left-Hand Side Shown)

NOTE:

The head restraints should only be removed by qualified technicians, for service purposes only. If either of the head restraints require removal, see an authorized dealer.

Rear Head Restraints

The outboard head restraints are non-adjustable, but can be folded down for improved rearward visibility. Push the button on the outboard side of the head restraint to release. To return the head restraint to its upright position, push up on the head restraint until it locks back into place.

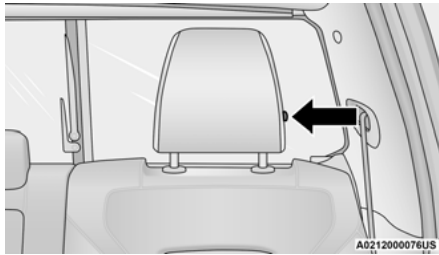

Release Button

WARNING!

Sitting in a seat with the head restraint in its lowered position could result in serious injury or death in a collision. Always make sure the outboard head restraints are in their upright positions when the seat is to be occupied.

The center head restraint is not adjustable or removable.

NOTE:

The head restraints should only be removed by qualified technicians, for service purposes only. If any of

the head restraints require removal, see an authorized dealer.

For child restraint tethering, see ⇨ page 302.

UCONNECT VOICE RECOGNITION — IF EQUIPPED

INTRODUCING VOICE RECOGNITION

Start using Uconnect Voice Recognition with these helpful quick tips. It provides the key Voice Commands and tips you need to know to control your vehicle's Voice Recognition (VR) system.

BASIC VOICE COMMANDS

The following basic Voice Commands can be given at any point while using your Uconnect system.

Push the VR button or say the vehicle's "Wake Up" word, "Hey Uconnect". After the beep, say:

- **"Cancel"** to stop a current voice session.
- **"Help"** to hear a list of suggested Voice Commands.
- **"Repeat"** to listen to the system prompts again.

Notice the visual cues that inform you of your Voice Recognition system's status.

NOTE:

On Uconnect 5 systems, the factory default "Wake Up" word is set to "Hey Uconnect" and can be reprogrammed through the Uconnect Settings.

GET STARTED

The  VR button is used to activate/deactivate your Voice Recognition system.

Helpful hints for using Voice Recognition:

1. Visit UconnectPhone.com to check mobile device and feature compatibility and to find phone pairing instructions.
2. Reduce background noise. Wind noise and passenger conversations are examples of noise that may impact recognition.
3. Speak clearly at a normal pace and volume while facing straight ahead. The microphone is located in the headliner and aimed at the driver.
4. Each time you give a Voice Command, you must first push either the VR or Phone button, wait until after the beep, then say your Voice Command. You can also say the vehicle "Wake Up" word and state your command. Some examples of "Wake Up" words include "Hey Uconnect" or "Hey Ram".
5. You can interrupt the help message or system prompts by pushing the VR or Phone button and saying a Voice Command from the current category.

NOTE:

If your vehicle is not equipped with Voice Recognition, you may still have voice recognition buttons. These buttons will work with Android Auto™ and Apple CarPlay® by initiating a Siri or Google Assistant voice recognition session. Depending on your device, you may need to press and hold the VR button for one second to begin a voice recognition session.



Uconnect Voice Command Buttons

1 — For The Uconnect 5/5 NAV System Vehicles Equipped With Navigation: Push The Phone Button To Begin Radio, Media, Navigation, Climate, Start Or Answer A Phone Call, And Send Or Receive A Text. For Systems without Navigation: Push the Phone button to answer an incoming call.

2— Push The Hang Up Button To End A Call Currently In Progress

ADDITIONAL INFORMATION

© 2024 FCA US LLC. All rights reserved. Mopar and Uconnect are registered trademarks and Mopar Owner Connect is a trademark of FCA US LLC. SiriusXM® and all related marks and logos are trademarks of SiriusXM® Radio Inc.

Uconnect System Support:

- US residents visit www.driveuconnect.com or call: 1-877-855-8400 (24 hours a day 7 days a week)

- Canadian residents visit www.driveuconnect.ca or call: 1-800-465-2001 (English) or 1-800-387-9983 (French)

Brand Connect services support:

- US residents visit www.driveuconnect.com or call: 1-800-777-3600
- Canadian residents visit <https://www.driveuconnect.ca/en> or call: 1-800-777-3600

DRIVER ADJUSTABLE PEDALS — IF EQUIPPED

The adjustable pedals system is designed to allow a greater range of driver comfort for steering wheel tilt and seat position. This feature allows the brake and accelerator pedals to move toward or away from the driver to provide improved position with the steering wheel.

The adjustable pedal switch is located on the instrument panel, below the headlight switch.

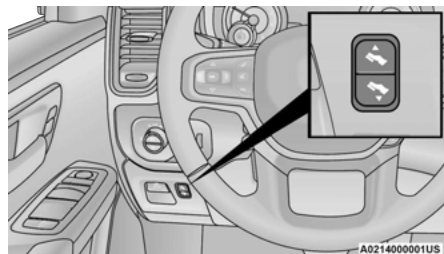

Adjustable Pedals Switch

The pedals **cannot** be adjusted when the vehicle is in REVERSE or when the Adaptive Cruise Control system is on. If there is an attempt to adjust the pedals when the system is locked out, one of the following messages will appear (on vehicles equipped with an instrument cluster):

- Adjustable Pedal Disabled — Adaptive Cruise Control Engaged
- Adjustable Pedal Disabled — Vehicle In Reverse

NOTE:

- Always adjust the pedals to a position that allows full movement of the pedal.
- Further small adjustments may be necessary to find the best possible seat/pedal position.
- For vehicles equipped with Driver Memory Settings ➞ page 31, you can use your key fob or the memory switch on the driver's door trim panel to return the adjustable pedals to saved positions.

WARNING!

- Do not adjust the pedals while the vehicle is moving. You could lose control and have an accident. Always adjust the pedals while the vehicle is parked.
- Do not allow anything to be placed under the adjustable pedals that could impede their movement. Failure to follow this warning could interfere with the accelerator, brake, or clutch pedals and cause damage to the pedals or a loss of control which could result in serious injury or death.

MIRRORS**INSIDE REARVIEW MIRROR****Manual Mirror – If Equipped**

The mirror head can be adjusted up, down, left, and right. The mirror should be adjusted to center on the view through the rear window.

Headlight glare from vehicles behind you can be reduced by moving the small control under the mirror to the night position (toward the rear of the vehicle). The mirror should be adjusted while set in the day position (toward the windshield).

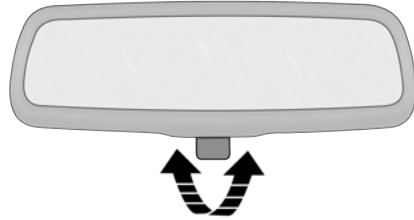
**Adjusting Rearview Mirror****Automatic Dimming Mirror – If Equipped**

The rearview mirror can be adjusted up, down, left, and right. The mirror should be adjusted to center on the view through the rear window.

This mirror automatically adjusts for headlight glare from vehicles behind you.

NOTE:

The Automatic Dimming Mirror feature is disabled when the vehicle is in REVERSE to improve the driver's rear view.

The Automatic Dimming feature can be turned on or off through the touchscreen.

**Automatic Dimming Mirror****CAUTION!**

To avoid damage to the mirror during cleaning, never spray any cleaning solution directly onto the mirror. Apply the solution onto a clean cloth and wipe the mirror clean.

Digital Rearview Mirror – If Equipped

The Digital Rearview Mirror provides a high definition, wide and unobstructed view of the road and traffic behind the vehicle, as well as a trailer when Tow Mode Camera is equipped, while driving forward (not recommended for use as a Back Up Camera).

Position the mirror in the regular Automatic Dimming Mirror mode, then activate the Digital Rearview Mirror mode.

To activate the Digital Rearview Mirror, pull the on/off control lever on the bottom of the mirror rearward toward the driver.

When Digital Rearview Mode is not in use, push the on/off control lever forward toward the windshield to return the mirror to the regular Automatic Dimming Mirror.

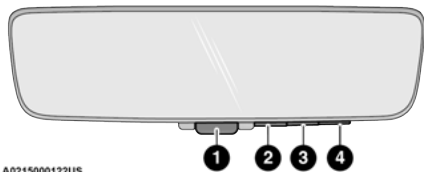

A021500012ZUS

Digital Rearview Mirror

- 1 — On/Off Control/Toggle
- 2 — Menu Button
- 3 — Left Scroll Button
- 4 — Right Scroll Button

Use the left and right buttons to scroll through available camera view options.

Rearview Camera (Back Of Vehicle)

This is the default view of the Digital Rearview Camera. It displays a wide screen view of the back of the vehicle.

Tow Mode (Back Of Trailer) — If Equipped

The Tow Mode will display a wide screen view of the back of the trailer using an auxiliary camera.

Push the Menu button next to the on/off control to access the following mirror adjustment options:

- Tilt (up/down)
- Pan (left/right)
- Rotate
- Zoom
- Brightness

Push the Menu button to scroll through the menu options and use left and right scroll buttons to change settings.

The menu will lockout when vehicle is traveling above 8 mph (12 km/h). Once this happens, the menu options cannot be changed (view can still be changed).

NOTE:

The Digital Rearview Mirror is not as effective during nighttime driving in low light applications due to low ambient light levels. In the event that it provides the user with less than expected vision, the mirror can be reverted to a normal reflective Automatic Dimming Mirror by pushing the on/off control lever toward the windshield and putting the mirror into Automatic Dimming Mirror mode.

Tow Mode — If Equipped

Your vehicle may be equipped with an additional auxiliary trailer camera to be mounted on the rear of a trailer. When the camera is connected, the display in the Digital Rearview Mirror automatically switches to the trailer camera.

To return to the Rearview Camera display toggle through the menu options using the control buttons on the mirror.

The following indications may be displayed on the Digital Rearview Mirror:

Digital Mode



This indication will appear when the Rearview Camera is utilizing the cameras on the vehicle.

Tow Mode



This indication will appear when the Rearview Camera is utilizing an auxiliary camera attached to the trailer.

View Switching In Progress



This indication will appear when camera view switching is in progress.

Camera Signal Lost (Single View)



This indication will appear when the Rearview Camera has lost its signal.

Camera Signal Lost (Multi-View)



This indication will appear when the camera affected has lost its signal in either Split Screen or Tri-View.

Communication Lost

This indication will appear when the Digital Rearview Camera has lost communication with the vehicle.

If a camera signal is lost, switch to Automatic Dimming Mirror mode.

For more information on trailer camera options, see page 204.

WARNING!

The Digital Rearview Mirror mode has a limited view. Portions of the road, vehicles, and other objects may not be seen, especially while backing up.

ILLUMINATED VANITY MIRROR — IF EQUIPPED

To access an illuminated vanity mirror, flip down one of the visors and lift the cover.

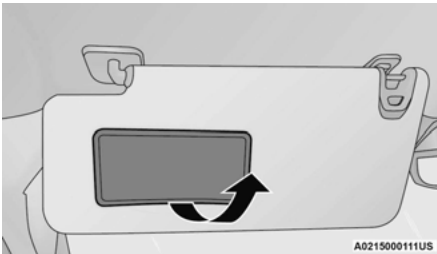

Lift Cover For Illuminated Mirror

Slide-On-Rod Features Of Sun Visor — If Equipped

The sun visor Slide-On-Rod feature allows for additional flexibility in positioning the sun visor to block out the sun.

1. Fold down the sun visor.
2. Unclip the visor from the corner clip.
3. Pivot the sun visor toward the side window.
4. Extend the sun visor for additional sun blockage.

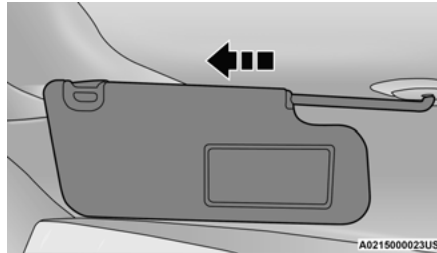

Slide-On-Rod Extender

NOTE:

The sun visor can also be extended while the sun visor is against the windshield for additional sun blockage through the front of the vehicle.

OUTSIDE MIRRORS

The outside mirror(s) can be adjusted to the center of the adjacent lane of traffic to achieve the optimal view.

NOTE:

If your vehicle is equipped with puddle lamps under the outside mirrors, they can be turned off through the Uconnect system page 227.

WARNING!

Vehicles and other objects seen in an outside convex mirror will look smaller and farther away than they really are. Relying too much on side convex mirrors could cause you to collide with another vehicle or other object. Use your inside mirror when judging the size or distance of a vehicle seen in a side convex mirror.

Trailer Tow Telescoping Mirrors

Your vehicle may be equipped with manual or power trailer telescoping mirrors. These mirrors are designed with an adjustable mirror head that can be extended when trailering to provide a greater vision range when towing extra-wide loads.

Power Telescoping Mirrors

The Power Telescoping Mirror Switch is located on the door trim panel, above the power mirror controls. The switch enables the driver to extend or retract the mirror head.

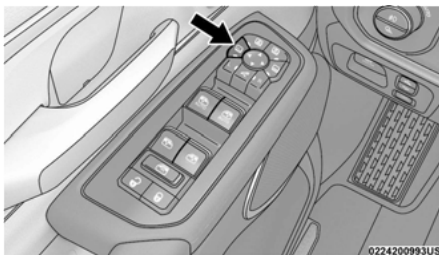

Power Telescoping Mirror Switch

To adjust the outside mirrors, push the Telescoping Mirror Switch. Pressing left on the directional pad extends the mirrors outward, pressing right on the directional pad retracts the mirrors back to the inward position.

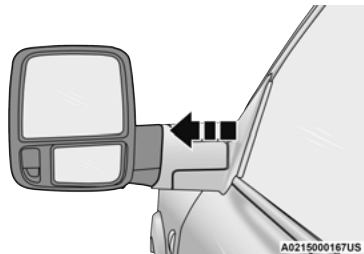

Power Telescoping Mirror (Extended Position)

To return the control to the large mirror, push the Power Telescoping Mirror Switch a second time.

Manual Telescoping Mirrors

To extend the Manual Telescoping Mirrors pull the mirror outward to desired position. To return to normal position, push the mirror inward all the way.

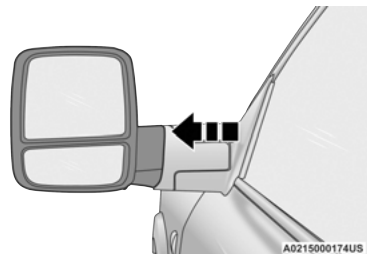

Manual Telescoping Mirror (Extended Position)

NOTE:

Be sure to fold the mirrors prior to entering an automated car wash.

Outside Mirrors Folding Feature

All outside mirrors are hinged and may be moved either forward or rearward to resist damage. The hinges have three positions:

- Full forward position
- Full rearward position
- Normal position

CAUTION!

It is recommended to fold the mirrors into the full rearward position to resist damage when entering a car wash or a narrow location.

Outside Mirrors With Turn Signal And Approach Lighting — If Equipped

Driver and passenger outside mirrors with turn signal and approach lighting contain LEDs, which are located on the bottom of the mirror head and, if equipped, your vehicle may contain logo lights which are located under the mirror base.

The outer LEDs are turn signal indicators, which flash with the corresponding turn signal lights in the front and rear of the vehicle. Turning on the Hazard Warning flashers will also activate these LEDs.

The approach lighting, which turns on in both mirrors when you use the key fob or open any door is located on the underside of the mirror.

The illuminated entry lighting fades to off after about 30 seconds or it will fade to off immediately once the vehicle is placed in the ON/RUN position.

NOTE:

The approach lighting will not function when the gear selector is moved out of the PARK position.

OUTSIDE AUTOMATIC DIMMING MIRRORS — IF EQUIPPED

The driver's outside mirror and, if equipped, the passenger's outside mirror, will automatically dim for glare from vehicles behind you. This feature is controlled by the inside automatic dimming mirror. The mirrors will automatically adjust for headlight glare when the inside mirror adjusts.

POWER MIRRORS

The power mirror switch is located on the driver's side door trim panel.

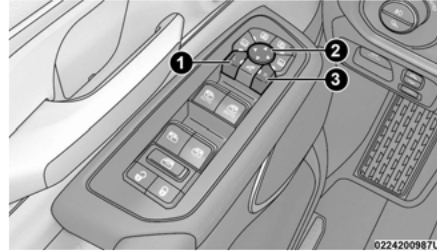

Power Mirror Controls

- 1 — Left Mirror Selection
- 2 — Mirror Direction Control
- 3 — Right Mirror Selection

The power mirror controls consist of mirror select buttons and a four-way mirror control switch. To adjust a mirror, push the mirror select button for the mirror that you want to adjust. Using the mirror control switch, push on any of the four arrows for the direction that you want the mirror to move.

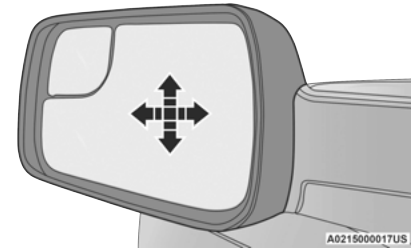

Power Mirror Movement

Power mirror preselected positions can be controlled by the optional Driver Memory Settings feature → page 31.

POWER FOLDING OUTSIDE MIRRORS — IF EQUIPPED

The power folding mirrors can be folded rearward and unfolded into the normal driving position.

The switch for the power folding mirrors is located between the power mirror switches L (left) and R (right). Push the switch once and the mirrors will fold in, push the switch a second time and the mirrors will return to the normal driving position.

If the mirror is manually folded after a powered cycle, a potential extra button push is required to get the mirrors back to the normal driving position. If the mirror does not fold automatically, check for ice or dirt buildup at the pivot area, which can cause excessive drag.

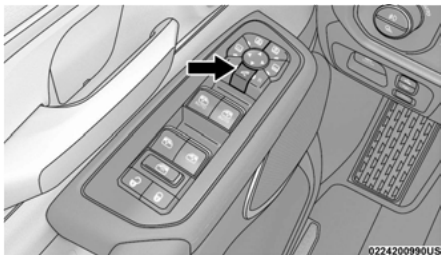

Power Folding Mirror Switch

Resetting The Power Folding Outside Mirrors

You may need to reset the power folding mirrors if the following occurs:

- The mirrors are accidentally blocked while folding.
- The mirrors are accidentally manually folded/unfolded (by hand or by pushing the power folding mirror switch).
- The mirrors come out of the unfolded position.
- The mirrors shake and vibrate at normal driving speeds.

To reset the power folding mirrors: Fold and unfold them by pushing the button (this may require multiple attempts). This resets them to their normal driving position.

AUTOMATIC POWER FOLDING MIRRORS — IF EQUIPPED

When enabled within Uconnect Settings ⇨ page 227, the exterior mirrors will automatically fold when the vehicle is placed in the OFF position, and after the doors are locked and closed.

The exterior mirrors will auto-fold in the following situations after the vehicle is placed in the OFF position:

- Pushing the lock button on the door panel before the door is opened.

NOTE:

If the doors are already locked, push the lock button again.

- Opening the door, then pushing the lock button on the door panel, followed by closing the door.
- After exiting the vehicle, close the doors then push the lock button on the key fob.
- After exiting the vehicle, close the doors then touch the lock icon on the Passive Entry door handle.

Automatic Unfolding

If the exterior mirrors were folded automatically, they will unfold based on the selection with the Uconnect system:

- When the vehicle is unlocked using the key fob
- When the vehicle is unlocked using a Passive Entry door handle

- When Proximity Wake-Up is activated ⇨ page 55
- When the vehicle is placed in the ON/RUN position

NOTE:

If the mirrors were folded manually by using the power folding mirror switch on the driver's door panel, they will not automatically unfold.

POWER CONVEX MIRROR SWITCH — IF EQUIPPED

The Power Convex Mirror Switch is located on the door trim panel, above the power mirror controls. The switch enables the movement of the convex portion of both the driver and passenger outside mirrors.

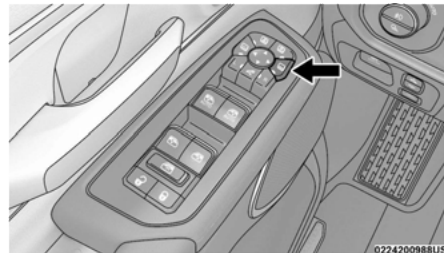

Power Convex Mirror Switch

To adjust the convex portion of the outside mirrors, push the Power Convex Mirror Switch. Then, select the mirror you want to adjust by using the L (left) or R (right) buttons. Using the mirror control switch, push any of the four arrows for the direction you want the mirror to move.

To return the control to the large mirror, push the Power Convex Mirror Switch a second time.

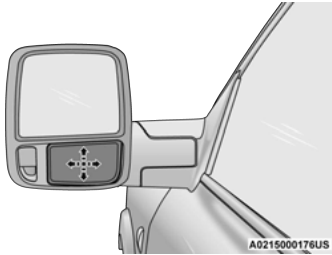

Trailer Tow Power Convex Mirror

NOTE:

If the Power Convex Mirror Switch is not pushed a second time, the switch will automatically default back to the larger portion of the outside mirrors after a period of time.

FORWARD UTILITY LIGHTS AND REAR GUIDANCE LIGHTS — IF EQUIPPED

The forward utility lights and reverse guidance lights switches are located on the drivers door trim panel, above the power mirror controls. These switches enable the forward or reverse lights located on the driver and passenger outside mirrors.

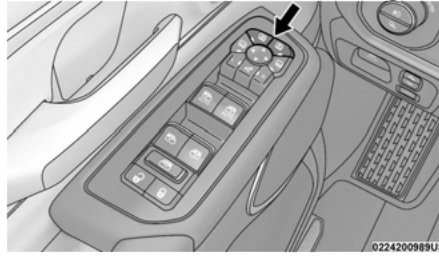

Forward and Reverse Light Switches

When either button is pressed the corresponding light on the outside mirror will remain on for ten minutes. The vehicle must be in the ON/RUN or ACC position. When the light is active, the switch on the door panel will illuminate. Pushing the switch a second time will turn the lights off.

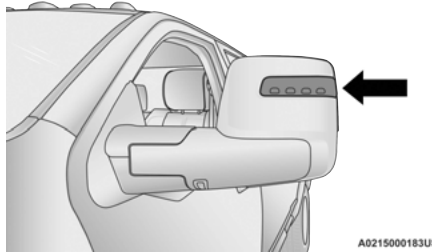

Forward Utility Light

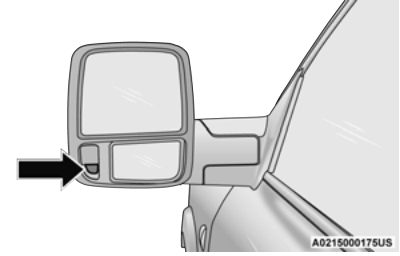

Reverse Guidance Light

When the lights are activated using the switch on the door panel, the reverse guidance lights will illuminate when the vehicle transmission is in PARK, NEUTRAL, or REVERSE and the forward utility lights will illuminate in all ignition positions. The rear guidance lights will turn off when the vehicle transmission is placed in DRIVE.

The rear guidance lights will also illuminate when the cargo light switch is pressed on the headlight switch panel. This feature is programmable through the Uconnect system → page 227

HEATED MIRRORS — IF EQUIPPED



These mirrors are heated to melt frost or ice. This feature will be activated whenever you turn on the rear window defroster (if equipped) → page 60.

NOTE:

If equipped, mirrors may be installed with Electrochromic (EC) glass. EC glass may defrost slower than non-EC glass due to the thickness of the material.

UNIVERSAL GARAGE DOOR OPENER (HOMELINK®) — IF EQUIPPED

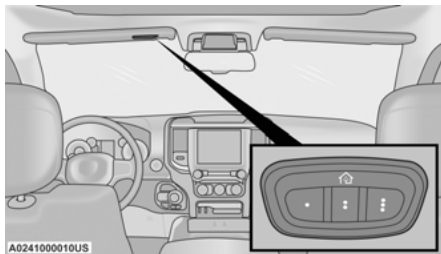

HomeLink® Buttons

Scan this QR code to learn more about HomeLink® (Garage Door Opener)



- HomeLink® replaces up to three hand-held transmitters that operate devices such as garage door openers, motorized gates, lighting, or home security systems. The HomeLink® unit is powered by your vehicle's 12 Volt battery.
- The HomeLink® buttons that are located in the overhead console or sun visor designate the three different HomeLink® channels.
- To operate HomeLink®, push and release any of the programmed HomeLink® buttons. These buttons will

activate the devices they are programmed to with each press of the corresponding HomeLink® button.

- The HomeLink® indicator light is located above the center button.

NOTE:

HomeLink® is disabled when the Vehicle Security system is active ➔ page 422.

BEFORE YOU BEGIN PROGRAMMING HOMELINK®

For efficient programming and accurate transmission of the Radio Frequency (RF) signal, it is recommended that a new battery be placed in the hand-held transmitter of the device that is being programmed to the HomeLink® system. Make sure your hand-held transmitter is programmed to activate the device you are trying to program your HomeLink® button to.

Ensure that your vehicle is parked outside of the garage before you begin programming.

It is recommended that you erase all the channels of your HomeLink® before you use it for the first time.

ERASING ALL THE HOMELINK® CHANNELS

To erase the channels, follow this procedure:

1. Place the ignition switch into the ON/RUN position.
2. Push and hold the two outside HomeLink® buttons (I and III) for up to 20 seconds, or until the HomeLink® indicator light flashes.

NOTE:

Erasing all channels should only be performed when programming HomeLink® for the first time. Do not erase channels when programming additional buttons.

IDENTIFYING WHETHER YOU HAVE A ROLLING CODE OR NON-ROLLING CODE DEVICE

Before programming a device to one of your HomeLink® buttons, you must determine whether the device has a rolling code or non-rolling code.

Rolling Code Devices

To determine if your device has a rolling code, a good indicator is its manufacturing date. Typically, devices manufactured after 1995 have rolling codes. A device with a rolling code will also have a "LEARN" or "TRAIN" button located where the antenna is attached to the device. The button may not be immediately visible when looking at the device. The name and color of the button may vary slightly by manufacturer.

NOTE:

The "LEARN" or "TRAIN" button is not the button you normally use to operate the device.

Non-rolling Code Devices

Most devices manufactured before 1995 will not have a rolling code. These devices will also not have a "LEARN" or "TRAIN" button.

PROGRAMMING HOMELINK® TO A GARAGE DOOR OPENER

To program any of the HomeLink® buttons to activate your garage door opener motor, proceed as follows:

NOTE:

All HomeLink® buttons are programmed using this procedure. You do not need to erase all channels when programming additional buttons.

1. Place the ignition switch into the ON/RUN position.
2. Place the garage door opener transmitter 1 to 3 inches (3 to 8 cm) away from the HomeLink® button you wish to program, while keeping the HomeLink® indicator light in view.
3. Push and hold the HomeLink® button you want to program while you push and hold the garage door opener transmitter button you are trying to replicate.
4. Continue to hold both buttons and observe the HomeLink® indicator light. The HomeLink® indicator light will flash slowly and then rapidly. Once this happens, release both buttons.

NOTE:

Make sure the garage door opener motor is plugged in before moving on to the rolling code/non-rolling code final steps.

Rolling Code Garage Door Opener Final Steps**NOTE:**

You have 30 seconds in which to initiate rolling code final step 2, after completing rolling code final step 1.

1. At the garage door opener motor (in the garage), locate the "LEARN" or "TRAIN" button. This can usually be found where the hanging antenna wire is attached to the garage door opener motor. Firmly push and release the "LEARN" or "TRAIN" button.

2. Return to the vehicle and push the programmed HomeLink® button three times (holding the button for two seconds each time). If the garage door opener motor operates, programming is complete.
3. Push the programmed HomeLink® button to confirm that the garage door opener motor operates. If the garage door opener motor does not operate, repeat the final steps for the rolling code procedure.

Non-Rolling Code Garage Door Opener Final Steps

1. Push and hold the programmed HomeLink® button and observe the HomeLink® indicator light. If the HomeLink® indicator light stays on constantly, programming is complete.
2. Push the programmed HomeLink® button to confirm that the garage door opener motor operates. If the garage door opener motor does not operate, repeat the steps from the beginning.

WARNING!

- Your motorized door or gate will open and close while you are programming the universal transmitter. Do not program the transmitter if people or pets are in the path of the door or gate.
- Do not run your vehicle in a closed garage or confined area while programming the transmitter. Exhaust gas from your vehicle contains carbon monoxide which is odorless and colorless. Carbon monoxide is poisonous when inhaled and can cause you and others to be severely injured or killed.

PROGRAMMING HOMELINK® TO A MISCELLANEOUS DEVICE

The procedure on how to program HomeLink® to a miscellaneous device follows the same procedure as programming to a garage door opener → page 50. Be sure to determine if the device has a rolling code, or non-rolling code before beginning the programming process.

NOTE:

Canadian Radio Frequency (RF) laws require transmitter signals to time-out (or quit) after several seconds of transmission, which may not be long enough for HomeLink® to pick up the signal during programming. Similar to this Canadian law, some U.S. gate operators are designed to time-out in the same manner. The procedure may need to be performed multiple times to successfully pair the device to your HomeLink® buttons.

REPROGRAMMING A SINGLE HOMELINK® BUTTON

To reprogram a single HomeLink® button that has been previously trained, without erasing all the channels, refer to the following procedure. Be sure to determine whether the new device you want to program the HomeLink® button to has a rolling code, or non-rolling code.

1. Place the ignition in the ON/RUN position, without starting the vehicle.

2. Push and hold the desired HomeLink® button until the HomeLink® indicator light begins to flash after 20 seconds. **Do not release the button.**
3. **Without releasing the button**, proceed with Step 2 in “Programming HomeLink® To A Garage Door Opener” ➔ page 50, and follow all remaining steps.

CANADIAN/GATE OPERATOR PROGRAMMING

For programming transmitters in Canada/United States that require the transmitter signals to “time-out” after several seconds of transmission:

Canadian Radio Frequency (RF) laws require transmitter signals to time-out (or quit) after several seconds of transmission, which may not be long enough for HomeLink® to pick up the signal during programming. Similar to this Canadian law, some U.S. gate operators are designed to time-out in the same manner.

It may be helpful to unplug the device during the cycling process to prevent possible overheating of the garage door or gate motor.

1. Place the ignition in the ON/RUN position.

NOTE:

For vehicles equipped with Keyless Enter 'n Go™, place the ignition in the RUN position. Make sure while programming HomeLink® with the engine on that your vehicle is outside of your garage, or that the garage door remains open at all times.

2. Place the hand-held transmitter 1 to 3 inches (3 to 8 cm) away from the HomeLink® button you wish

to program while keeping the HomeLink® indicator light in view.

3. Continue to push and hold the HomeLink® button while you push and release (cycle) your hand-held transmitter every two seconds until HomeLink® has successfully accepted the frequency signal. The indicator light will flash slowly and then rapidly when fully trained.
4. Watch for the HomeLink® indicator to change flash rates. When it changes, it is programmed. It may take up to 30 seconds or longer in rare cases. The garage door may open and close while you are programming.
5. Push and hold the programmed HomeLink® button and observe the indicator light.

NOTE:

- If the indicator light stays on constantly, programming is complete and the garage door/device should activate when the HomeLink® button is pushed.
- To program the two remaining HomeLink® buttons, repeat each step for each remaining button. DO NOT erase the channels.

If you unplugged the garage door opener/device for programming, plug it back in at this time.

Reprogramming A Single HomeLink® Button (Canadian/Gate Operator)

To reprogram a channel that has been previously trained, follow these steps:

1. Place the ignition in the ON/RUN position.

2. Press and hold the desired HomeLink® button until the indicator light begins to flash after 20 seconds. Do not release the button.
3. Without releasing the button, proceed with “Canadian/Gate Operator Programming” Step 2 and follow all remaining steps.

SECURITY

It is advised to erase all channels before you sell or turn in your vehicle.

To do this, push and hold the two outside buttons for 20 seconds until the indicator flashes. Note that all channels will be erased. Individual channels cannot be erased.

The HomeLink® universal transmitter is disabled when the Vehicle Security system is active.

TROUBLESHOOTING TIPS

If you are having trouble programming HomeLink®, here are some of the most common solutions:

- Replace the battery in the garage door opener hand-held transmitter.
- Push the LEARN button on the garage door opener to complete the training for a rolling code.
- Did you unplug the device for programming and remember to plug it back in?

If you have any problems, or require assistance, please call toll-free 1-800-355-3515 or, on the Internet at HomeLink.com for information or assistance.

WARNING!

- Vehicle exhaust contains carbon monoxide, a dangerous gas. Do not run your vehicle in the garage while programming the transmitter. Exhaust gas can cause serious injury or death.
- Your motorized door or gate will open and close while you are programming the universal transmitter. Do not program the transmitter if people, pets or other objects are in the path of the door or gate. Only use this transmitter with a garage door opener that has a “stop and reverse” feature as required by Federal safety standards. This includes most garage door opener models manufactured after 1982. Do not use a garage door opener without these safety features.

EXTERIOR LIGHTS**HEADLIGHT SWITCH**

The headlight switch is located on the left side of the instrument panel. This switch controls the operation of the headlights, parking lights, automatic headlights (if equipped), instrument panel light dimming, cargo light/trailer spotter lights (if equipped), and fog lights (if equipped).

For RHO Models: The headlight switch also controls the clearance lamps and the front and rear identification lamps. The clearance lamps and the front and rear identification lamps will turn on when the switch is in the On, AUTO, or parking lights position. These lamps are activated to allow other drivers to spot and identify the vehicle.

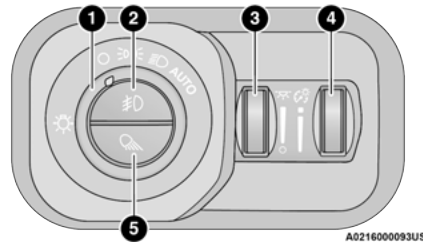
**Headlight Switch**

- 1 — Rotate Headlight Control
- 2 — Push Fog Light Switch
- 3 — Ambient Light Dimmer Control
- 4 — Instrument Panel Dimmer Control
- 5 — Push Cargo Light Switch

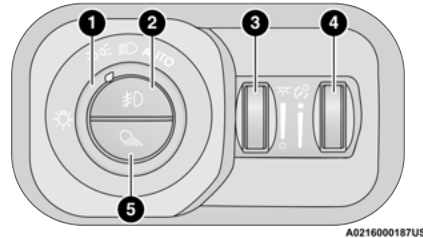
**Headlight Switch (Vehicles Sold In Canada)**

- 1 — Rotate Headlight Control
- 2 — Push Fog Switch
- 3 — Ambient Light Dimmer Control
- 4 — Instrument Panel Dimmer Control
- 5 — Push Cargo Light Switch

NOTE:

Vehicles sold in Canada are equipped with a headlight switch with an AUTO and ON detent but without an OFF detent. Headlights will be deactivated when the headlight switch is placed in the parking lights position. However, the Daytime Running Lights (DRLs) will be activated along with the front and rear marker lights. The DRLs may be deactivated when the parking brake is engaged.

To turn on the headlights, rotate the headlight switch clockwise. When the headlight switch is on, the parking lights, taillights, license plate light and instrument panel lights are also turned on. To turn off the headlights, rotate the headlight switch back to the O (off) position.

NOTE:

For vehicles sold in Canada, rotate the headlight switch clockwise from the parking lights and instrument panel lights position to the first detent to turn on headlights, parking lights, and instrument panel lights. Rotate the headlight switch to the second detent for the AUTO position.

CAUTION!

Do not use abrasive cleaning components, solvents, steel wool or other abrasive materials to clean the lenses.

NOTE:

- Your vehicle is equipped with plastic headlight and fog light (if equipped) lenses that are lighter and less susceptible to stone breakage than glass lights. Plastic is not as scratch resistant as glass and therefore different lens cleaning procedures must be followed.
- To minimize the possibility of scratching the lenses and reducing light output, avoid wiping with a dry cloth. To remove road dirt, wash with a mild soap solution followed by rinsing.

MULTIFUNCTION LEVER

The multifunction lever is located on the left side of the steering column.

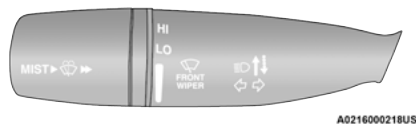

Multifunction Lever

DAYTIME RUNNING LIGHTS (DRLs)

The Daytime Running Lights (DRLs) come on whenever the vehicle is running, and the low beams are not on. The lights will remain on until the power button is placed in the OFF position, or the parking brake is engaged.

NOTE:

- For vehicles sold in Canada, the Daytime Running Lights will automatically deactivate when the front fog lights are turned on.
- If allowed by law in the country in which the vehicle was purchased, the Daytime Running Lights can be turned on and off using the Uconnect system ➞ page 227.
- On some vehicles, the Daytime Running Lights may deactivate, or reduce intensity, on one side of the vehicle (when a turn signal is activated on that side), or on both sides of the vehicle (when the hazard warning lights are activated).

HIGH/LOW BEAM SWITCH

Push the multifunction lever toward the instrument panel to switch the headlights to high beams. Pulling the multifunction lever back will turn the low beams on.

AUTOMATIC HIGH BEAM HEADLAMP CONTROL — IF EQUIPPED

The Automatic High Beam Headlamp Control system provides increased forward lighting at night by automating high beam control through the use of a camera mounted on the inside rearview mirror or a windshield mounted camera. These cameras detect vehicle specific light and automatically switch from high beams to low beams until the approaching vehicle is out of view.

NOTE:

- The Automatic High Beam Headlamp Control can be turned on or off by selecting “ON” under “Auto Dim High Beams” within your Uconnect Settings ➞

page 227, as well as turning the headlight switch to the AUTO position.

- Broken, muddy, or obstructed headlights and taillights of vehicles in the field of view will cause headlights to remain on longer (closer to the vehicle). Also, dirt, film, and other obstructions on the windshield or camera lens will cause the system to function improperly.
- If the windshield or Automatic High Beam Headlamp Control mirror is replaced, the mirror must be re-aimed to ensure proper performance. See a local authorized dealer.
- To opt out of the Advanced Auto High Beam Sensitivity Control (default) and enter Reduced High Beam Sensitivity Control (not recommended), toggle the high beam lever six full on/off cycles within 10 seconds of placing the vehicle in the ON position. The system will return to the default setting upon placing the vehicle in the OFF position.

FLASH-TO-PASS

You can signal another vehicle with your headlights by lightly pulling the multifunction lever toward you. This will cause the high beam headlights to turn on, and remain on, until the lever is released.

AUTOMATIC HEADLIGHTS — IF EQUIPPED

This system automatically turns the headlights on or off according to ambient light levels. To turn the system on, rotate the headlight switch to the AUTO position.

When the system is on, the Headlight Delay feature is also on. This means the headlights will stay on for up to 90 seconds after you place the vehicle into the OFF

position. To turn the automatic headlights off, turn the headlight switch out of the AUTO position.

NOTE:

The vehicle must be running before the headlights will turn on in the Automatic Mode.

PARKING LIGHTS AND PANEL LIGHTS

To turn on the parking lights and instrument panel lights, rotate the headlight switch clockwise. To turn off the parking lights, rotate the headlight switch back to the O (off) position.

NOTE:

Vehicles sold in Canada are equipped with a headlight switch with an AUTO and ON detent but without an OFF detent. Headlights will be deactivated when the headlight switch is placed in the parking lights position. However, the Daytime Running Lights (DRLs) will be activated along with the front and rear marker lights. The DRLs may be deactivated when the parking brake is engaged.

AUTOMATIC HEADLIGHTS WITH WIPERS

If your vehicle is equipped with Automatic Headlights, it also has this customer-programmable feature. When your headlights are in the automatic mode and the vehicle is running, they will automatically turn on when the wiper system is on. This feature is programmable through the Uconnect system ➞ page 227.

If your vehicle is equipped with the Rain Sensing Wiper system ➞ page 60, and it is activated, the headlights will automatically turn on after the wipers complete five wipe cycles within approximately one

minute. They will turn off approximately four minutes after the wipers completely stop.

NOTE:

When your headlights come on during the daytime, the instrument panel lights will automatically dim to the lower nighttime intensity.

HEADLIGHT ILLUMINATION ON APPROACH

When enabled, the headlights, exterior door handle pocket lights (if equipped), and interior lights will illuminate when the unlock button on the key fob is pushed as the operator is approaching the vehicle. This feature can be turned on/off, and the length of time the headlights stay on can be programmed for up to 90 seconds within Uconnect Settings ➞ page 227.

Proximity Wake-Up — If Equipped

This feature is enabled/disabled within the Uconnect system, and is activated when the operator approaches the driver's door, passenger's door, or liftgate with a valid key fob on their person. Some exterior and interior lights will illuminate in order to provide an increased sense of welcome and security as the operator approaches the vehicle in the dark. "Headlight Illumination On Approach" must be selected and set to a time value other than zero within Uconnect Settings for Proximity Wake-Up to activate.

The doors may be locked or unlocked for this feature to activate, as long as the ignition is in the OFF position, or during a Remote Start event. It will not activate if the doors are locked and the ignition was placed in the ON/RUN position.

NOTE:

Proximity Wake-Up may not activate under the following conditions:

- After numerous consecutive activations, in order to conserve the vehicle's battery
- After the vehicle's engine has been off for several days

Headlight Animation — If Equipped

When "Headlight Illumination On Approach" is turned on, and set to a time value above zero, the exterior lights illuminate in a theatrical manner during approach to the vehicle. This feature is activated in the following situations:

- Proximity Wake-Up (if equipped) is activated
- Remote Start is activated
- The unlock button on the key fob is pushed

NOTE:

For Headlight Animation to activate with Remote Start or with the push of the unlock button, "Greeting Lights" must also be selected within the Uconnect system.

HEADLIGHT DELAY

To assist when exiting the vehicle, the headlight delay feature will leave the headlights on for up to 90 seconds. This delay is initiated when the vehicle is placed in the OFF position while the headlight switch is on, and then the headlight switch is cycled off. Headlight delay can be canceled by either turning the headlight switch on then off, or by placing the vehicle in the ON position.

NOTE:

- This feature can be programmed through the Uconnect system → page 227.
- The headlight delay feature is automatically activated if the headlight switch is left in the AUTO position when the vehicle is placed in the OFF position.

LIGHTS-ON REMINDER

If the headlights, parking lights, or cargo lights are left on after the vehicle is placed in the OFF position, the vehicle will chime when the driver's door is opened.

FOG LIGHTS — IF EQUIPPED

To activate the front fog lights, turn on the parking lights or low beam headlights and push the fog light switch located within the headlight switch. Pushing the fog light switch a second time will turn the front fog lights off.

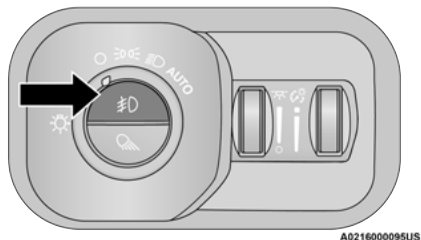
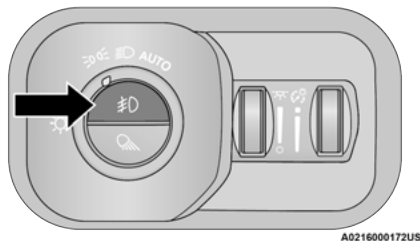
**Fog Light Button****Fog Light Switch (Vehicles Sold In Canada Only)**

The fog lights will operate only when the parking lights are on or when the vehicle headlights are on low beam. An indicator light located in the instrument cluster will illuminate when the fog lights are on. The fog lights will turn off when the button is pushed a second time, when the headlight switch is rotated to the O (off) position, or the high beam is selected.

If the fog lights are off, one of the fog lights will illuminate depending on the direction in which the vehicle is turning. This will provide increased visibility while turning, depending on the angle of the steering wheel.

TURN SIGNALS

Move the multifunction lever up or down to activate the turn signals. The arrows on each side of the instrument cluster flash to show proper operation.

NOTE:

- If either light remains on and does not flash, or there is a very fast flash rate, check for a defective outside light bulb.
- For information on Turn Signal Activated Blind Spot Assist (if equipped), see → page 292.

LANE CHANGE ASSIST — IF EQUIPPED

Lightly push the multifunction lever up or down, without moving beyond the detent, and the turn signal will flash three times then automatically turn off.

**CARGO LIGHTS/TRAILER SPOTTER LIGHTS/
TRAILER HITCH LIGHT WITH BED LIGHTS —
IF EQUIPPED**

The cargo light, bed lights, trailer spotter lights, and trailer hitch light are turned on by pushing the cargo light button located on the lower half of the headlight switch.

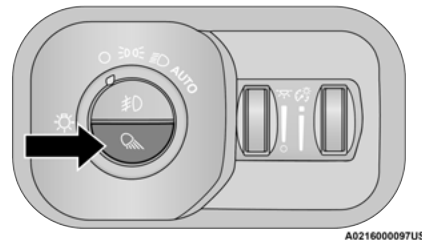
**Cargo/Bed Lights Button On Headlight Switch**

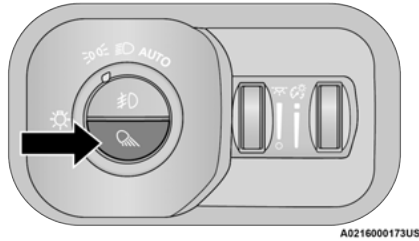

Cargo/Bed Lights Button On Headlight Switch (Vehicles Sold In Canada)

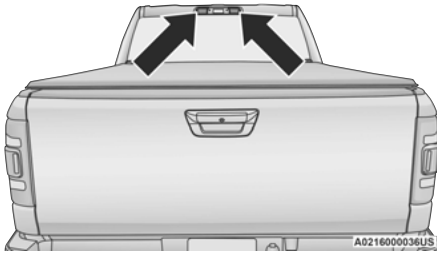

Cargo Lights

When the vehicle is stationary, these lights can also be turned on using the switch located just inside the pickup box, on the lower part of the bed light lens. A telltale will illuminate in the instrument cluster display when these lights are on. Pushing the switch a second time will turn the lights off.

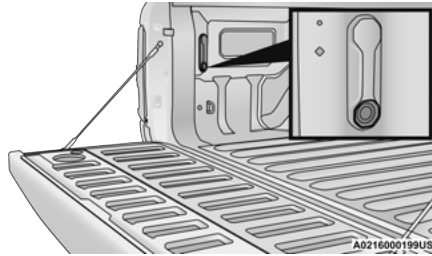

Bed Light Switch (Without RamBox)

The cargo light and bed lights (if equipped) will turn on for approximately 60 seconds when a key fob unlock button is pushed, as part of the Illuminated Entry feature.

When these lights are activated using the button on the headlight switch the cargo lights, trailer spotter lights, and trailer hitch light will remain illuminated when the vehicle transmission is in PARK, NEUTRAL, or REVERSE. The lights will turn off when the vehicle transmission is placed in DRIVE.

When the vehicle is placed in the REVERSE position, the trailer hitch light will turn on automatically. The trailer hitch light will turn off when the vehicle is placed in the DRIVE position.

NOTE:

The bed lights are not affected by gear selection.

NOTE:

For vehicles shipped to or sold in the states of California or Mississippi, the cargo, bed, and mirror spotter lights will not work while the vehicle is in

motion. In every other state, the cargo and mirror spotter lights will turn off when the vehicle is in motion, but the bed light will remain on.

BATTERY SAVER

Timers are set to both the interior and exterior lights to protect the life of your vehicle's battery.

After 10 minutes, if the vehicle is OFF and any door is left open or the dimmer control is rotated all the way up to the topmost position, the interior lights will automatically turn off.

NOTE:

Battery saver mode is canceled if the vehicle is ON.

The headlights will automatically turn off after eight minutes while the vehicle is in the OFF position.

INTERIOR LIGHTS

COURTESY LIGHTS

Courtesy and dome lights are turned on when the doors are opened or the Dome ON button is pushed on the overhead console. If your vehicle is equipped with Remote Keyless Entry and the unlock button is pushed on the key fob, the courtesy and dome lights will turn on. When a door is open and the interior lights are on, and the Dome Defeat button on the overhead console is pressed, the interior lights will turn off.

Front Map/Reading Lights

The overhead console lights can also be operated individually as reading lights by pushing the corresponding buttons.

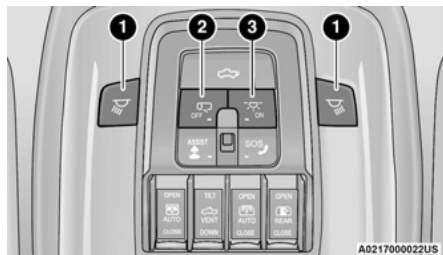

Front Courtesy/Reading Lights

- 1 — Reading Light On/Off Buttons
- 2 — Dome Defeat Button
- 3 — Dome ON Button

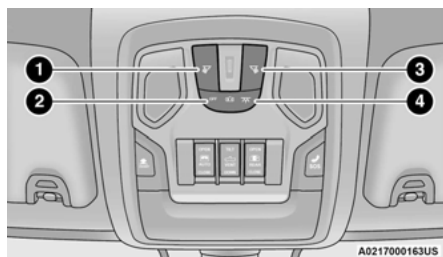

Front Courtesy/Reading Lights

- 1 — Driver's Reading Light On/Off Button
- 2 — Dome Defeat Button
- 3 — Passenger's Reading Light On/Off Button
- 4 — Dome On Button

Three types of rear courtesy/reading lights are available for your vehicle.

- Push button on/off
- Push lens on/off
- Push round puck lens on/off (if equipped with Dual Pane Sunroof)

NOTE:

The courtesy/reading lights will remain on until the switch is pushed a second time, so be sure they have been turned off before exiting the vehicle. If the interior lights are left on after the vehicle is turned off, they will automatically turn off after 10 minutes.

Dimmer Controls

The dimmer controls are inboard and adjacent to the headlight switch located on the left side of the instrument panel.

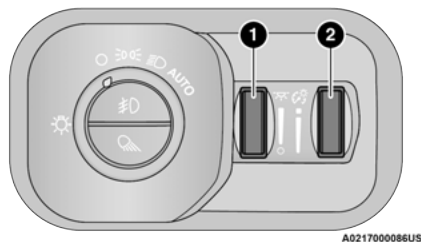

Dimmer Controls

- 1 — Ambient Light Control (If Equipped)
- 2 — Instrument Panel Dimmer Control

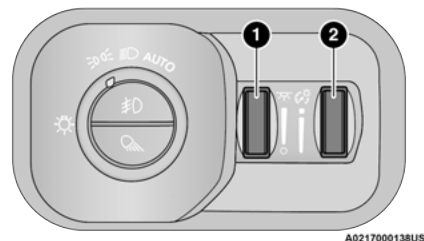

Dimmer Controls (Vehicles Sold In Canada Only)

- 1 — Ambient Light Control
- 2 — Instrument Panel Dimmer Control

With the parking lights or headlights on, rotating the instrument panel dimmer control upward will increase the brightness of the instrument panel lights. Rotating the ambient dimmer control will adjust the interior and ambient light levels when the headlights are on.

Dimming Of The Uconnect Touchscreen

The brightness of the Uconnect touchscreen can be dimmed using the instrument panel dimmer control when the parking lights or headlights are on.

When Display Mode is set to Auto within the Uconnect system, the brightness will automatically adjust from daytime intensity to nighttime intensity (and vice versa) based on ambient light levels outside of the vehicle.

NOTE:

The brightness of the Uconnect touchscreen cannot be adjusted when the instrument panel dimmer control is rotated to the upper most detent, even when Display Mode is set to Auto within the Uconnect Settings.

When Display Mode is set to Manual, the brightness of the Uconnect touchscreen will adjust to the set brightness (1 - 6) when the headlights are either on or off. For more information on these Uconnect Settings, see  page 227.

ILLUMINATED ENTRY

The courtesy lights will turn on when you use the key fob to unlock the doors or open any door.

This feature also turns on the approach lamps located beneath the outside mirrors (if equipped).

The lights will fade to off after approximately 30 seconds, or they will immediately fade to off once the vehicle is placed in the ON/RUN position from the OFF position.

The front courtesy overhead console and door courtesy lights will not turn off if the Dome ON button on the overhead console is pushed. The overhead and door courtesy lights will turn off after 10 minutes when the vehicle is placed in the OFF position to protect the battery.

The illuminated entry system will not operate if the Dome Defeat button on the overhead console is pushed.

NOTE:

If your vehicle is equipped with Illuminated Approach lights under the outside mirrors, they will also be turned off by pushing the Dome Defeat button.

WINDSHIELD WIPERS AND WASHERS

The windshield wiper/washer controls are located on the multifunction lever on the left side of the steering column. The front wipers are operated by rotating a switch, located on the end of the lever.

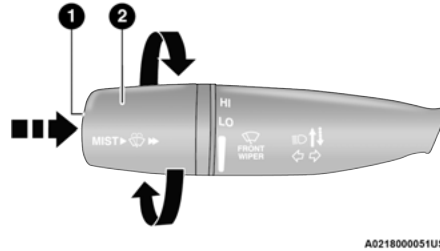

Windshield Wiper/Washer Lever

- 1 — Push End Inward (Hold For Washer Or Short Press For Mist)
- 2 — Rotate For Front Wiper Operation

WINDSHIELD WIPER OPERATION

NOTE:

Prior to activating the wiper system, manually clear excessive and unusually heavy snow/ice from windshield and cowl area.

Intermittent Wipers

The intermittent feature of this system was designed for use when weather conditions make a single wiping cycle, with a variable pause between cycles, desirable.

For maximum delay between cycles, rotate the control knob upward to the first detent.

The delay interval decreases as you rotate the knob until it enters the low continual speed position. The delay can be regulated from a maximum of about 18 seconds between cycles, to a cycle every one second. The delay intervals will double in duration when the vehicle speed is 10 mph (16 km/h) or less.

Windshield Washers

To use the windshield washer, push the washer knob, located on the end of the multifunction lever, inward and hold. Washer fluid will be sprayed and the wipers will operate for two to three cycles after the washer knob is released.

If the washer knob is pushed while in the delay range, the wipers will operate for several seconds after the washer knob is released. It will then resume the intermittent interval previously selected. If the washer knob is pushed while in the off position, the wipers will turn on and cycle approximately three times after the washer knob is released.

To prevent freeze-up of your windshield washer system in cold weather, select a solution or mixture that meets or exceeds the temperature range of your climate. This rating information can be found on most washer fluid containers.

WARNING!

Sudden loss of visibility through the windshield could lead to a collision. You might not see other vehicles or other obstacles. To avoid sudden icing

(Continued)

WARNING!

of the windshield during freezing weather, warm the windshield with the defroster before and during windshield washer use.

Mist

When a single wipe to clear off road mist or spray from a passing vehicle is needed, push the washer knob, located on the end of the multifunction lever, inward briefly and release. The wipers will cycle one time and automatically shut off.

NOTE:

The mist feature does not activate the washer pump; therefore, no washer fluid will be sprayed on the windshield. The washer function must be used in order to spray the windshield with washer fluid.

For information on wiper care and replacement, see  page 366.

RAIN SENSING WIPERS — IF EQUIPPED

This feature senses rain or snowfall on the windshield and automatically activates the wipers. Rotate the end of the multifunction lever to one of four detent positions to activate this feature.

The sensitivity of the system can be adjusted with the multifunction lever. Wiper delay position one is the least sensitive, and wiper delay detent position four is the most sensitive.

Wiper delay position three should be used for normal rain conditions.

Positions one and two can be used if the driver desires less wiper sensitivity. Position four can be used if the driver desires more sensitivity. Place the wiper switch in the O (off) position when not using the system.

NOTE:

- The Rain Sensing feature will not operate when the wiper switch is in the low or high-speed position.
- The Rain Sensing feature may not function properly when ice, or dried salt water is present on the windshield.
- Use of products containing wax or silicone may reduce Rain Sensing performance.
- The Rain Sensing feature can be turned on and off using the Uconnect system  page 227.

The Rain Sensing system has protection features for the wiper blades and arms, and will not operate under the following conditions:

- **Low Ambient Temperature** — When the vehicle is first placed in the ON position, the Rain Sensing system will not operate until the wiper switch is moved, vehicle speed is greater than 3 mph (5 km/h), or the outside temperature is greater than 32 °F (0 °C).
- **Transmission In NEUTRAL Position** — When the vehicle is ON, and the automatic transmission is in the NEUTRAL position, the Rain Sensing system will not operate until the wiper switch is moved, vehicle speed is greater than 3 mph (5 km/h), or the gear selector is moved out of the NEUTRAL position.
- **Remote Start Mode Inhibit** — On vehicles equipped with a Remote Start system, Rain Sensing wipers are not operational when the vehicle is in the Remote Start mode.

CLIMATE CONTROLS

The Climate Control system allows you to regulate the temperature, air flow, and direction of air circulating throughout the vehicle. The controls are located on the touchscreen, on the sides of the touchscreen, or on the instrument panel below the radio.

AUTOMATIC CLIMATE CONTROL DESCRIPTIONS AND FUNCTIONS

Uconnect 5 or 5 NAV With 8.4-inch Display Automatic Temperature Controls



**Uconnect 5 NAV With 12-inch
Display Automatic Temperature Controls**



**Uconnect 5 NAV With 14.5-inch
Display Automatic Temperature Controls**

NOTE:

Icons and descriptions can vary based upon vehicle equipment.

MAX A/C Button



Press and release the MAX A/C button on the touchscreen to change the current setting to the coldest output of air. The MAX A/C indicator illuminates when MAX A/C is on. Pressing the button again will cause the MAX A/C operation to exit.

NOTE:

- MAX A/C sets the control for maximum cooling performance.
- The MAX A/C button is only available on the touchscreen.

A/C Button



Press and release this button on the touchscreen, or push the button on the faceplate to change the current setting. The A/C indicator illuminates when A/C is on.

Recirculation Button



Press and release this button on the touchscreen, or push the button on the faceplate, to change the system between Recirculation mode and outside air mode.

The Recirculation indicator and the A/C indicator illuminate when the Recirculation button is pressed. Recirculation can be used when outside conditions, such as smoke, odors, dust, or high humidity are present. Recirculation can be used in all modes. Recirculation may be unavailable (button on the touchscreen greyed out) if conditions exist that could create fogging on the inside of the windshield. The A/C can be deselected manually without disturbing

the mode control selection. Continuous use of the Recirculation mode may make the inside air stuffy and window fogging may occur. Extended use of this mode is not recommended. Recirculation mode may automatically adjust to optimize customer experience for warming, cooling, dehumidification, etc.

In cold weather, use of Recirculation mode may lead to excessive window fogging. The recirculation feature may be unavailable if conditions exist that could create fogging on the inside of the windshield.

Auto Button



Set your desired temperature and press AUTO. AUTO will achieve and maintain your desired temperature by automatically adjusting the blower speed and air distribution. Air Conditioning (A/C) may be active during AUTO operation to improve performance. AUTO mode is highly recommended for efficiency.

You can turn AUTO on in one of two ways:

- Press and release this button on the touchscreen.
- Push the button on the faceplate.

toggling this function will cause the system to switch between manual mode and automatic mode → page 65.

Front Defrost Button



Press and release the Front Defrost button on the touchscreen, or push and release the button on the faceplate, to change the current airflow setting to Defrost mode. The Front Defrost indicator illuminates when Front Defrost

is on. Air comes from the windshield and side window demist outlets. When the defrost button is selected, the blower level may increase. Use Defrost mode with maximum temperature settings for best windshield and side window defrosting and defogging. When toggling the front defrost mode button, the climate system will return to the previous setting.

Rear Defrost Button



Press and release the Rear Defrost button on the touchscreen, or push and release the button on the faceplate, to turn on the rear window defroster and the heated outside mirrors (if equipped). The Rear Defrost indicator illuminates when the rear window defroster is on. The rear window defroster automatically turns off after 10 minutes.

CAUTION!

Failure to follow these cautions can cause damage to the heating elements:

- Use care when washing the inside of the rear window. Do not use abrasive window cleaners on the interior surface of the window. Use a soft cloth and a mild washing solution, wiping parallel to the heating elements. Labels can be peeled off after soaking with warm water.
- Do not use scrapers, sharp instruments, or abrasive window cleaners on the interior surface of the window.
- Keep all objects a safe distance from the window.

Driver And Passenger Temperature Up And Down Buttons

These buttons provide the driver and passenger with independent temperature control.



Push the red button (or rotate knob if equipped) on the faceplate, press the red button on the touchscreen, or press and slide the temperature bar towards the red arrow button on the touchscreen for warmer temperature settings.



Push the blue button (or rotate knob if equipped) on the faceplate, press the blue button on the touchscreen, or press and slide the temperature bar towards the blue arrow button on the touchscreen for cooler temperature settings.

NOTE:

- The numbers within the temperature display will only appear if the system is equipped with an automatic climate control system.
- Up and down buttons are only available on vehicles equipped with a 12-inch display.

SYNC Button



Press the SYNC button on the touchscreen to toggle the SYNC feature on/off. The SYNC indicator illuminates when SYNC is on. SYNC synchronizes the passenger temperature setting with the driver temperature setting. Changing the passenger's temperature setting while in SYNC will automatically exit this feature.

NOTE:

The SYNC button is only available on the touchscreen.

Blower Control



Blower Control regulates the amount of air forced through the climate control system. There are seven blower speeds available.

Adjusting the blower will cause automatic mode to switch to manual operation. The speeds can be selected using either the blower control knob on the faceplate or the buttons on the touchscreen.

Faceplate

The blower speed increases as you turn the blower control knob clockwise from the lowest blower setting. The blower speed decreases as you turn the blower control knob counterclockwise.

Touchscreen

Use the small blower icon to reduce the blower setting and the large blower icon to increase the blower setting. Blower can also be selected by pressing the blower bar area between the icons.

Mode Control



Select Mode by pressing one of the Mode buttons on the touchscreen, or pushing the Mode button on the faceplate, to change the airflow distribution mode. The airflow distribution mode can be adjusted so air comes from the instrument panel outlets, floor outlets, defrost outlets, and demist outlets.

Panel Mode



Air comes from the outlets in the instrument panel. Each of these outlets can be individually adjusted to direct the flow of air. The air vanes of the center outlets and outdoor outlets can be moved up and down or side to side to regulate airflow direction. There is a shut-off wheel located below the air vanes to shut off or adjust the amount of airflow from these outlets.

Bi-Level Mode



Air comes from the instrument panel outlets and floor outlets. A slight amount of air is directed through the defrost and side window demister outlets.

NOTE:

Bi-Level mode is designed under comfort conditions to provide cooler air out of the panel outlets and warmer air from the floor outlets.

Floor Mode



Air comes from the floor outlets. A slight amount of air is directed through the defrost and side window demister outlets.

Mix Mode



Air is directed through the floor, defrost, and side window demister outlets. This setting works best in cold or snowy conditions that require extra heat to the windshield. This setting is good for maintaining comfort while reducing moisture on the windshield.

Climate Control OFF Button



Press and release the OFF button on the touchscreen, or push the OFF button on the faceplate (if equipped) to turn the Climate Control on/off.

MANUAL CLIMATE CONTROL DESCRIPTIONS AND FUNCTIONS



Uconnect 5 With 8.4-inch Display Manual Temperature Controls

MAX A/C Setting



Set the temperature control knob to the MAX A/C setting to change the current setting to the coldest output of air. Moving the temperature control knob away from the MAX A/C setting causes the MAX A/C operation to exit.

A/C Button



Push the A/C button to engage the Air Conditioning (A/C). The A/C indicator illuminates when A/C is on.

NOTE:

- For Manual Climate Controls, if the system is in Mix, Floor or Defrost mode, the A/C can be turned off, but the A/C system shall remain active to prevent fogging of the windows.
- If fog or mist appears on the windshield or side glass, select Defrost mode, and increase blower speed if needed.
- If your air conditioning performance seems lower than expected, check the front of the A/C condenser (located in front of the radiator), for an accumulation of dirt or insects. Clean with a gentle water spray from the front of the radiator and through the condenser.

Recirculation Button



Push the Recirculation button to change the system between recirculation mode and outside air mode. The Recirculation indicator and the A/C indicator illuminate when the Recirculation button is pressed. Recirculation can be used when outside conditions, such as smoke, odors, dust, or humidity are present. Recirculation can be used in all modes except for Defrost. Recirculation may be unavailable if conditions exist that could create fogging on the inside of the windshield. The A/C can be deselected manually without disturbing the mode control selection. Continuous use of the Recirculation mode may make the inside air stuffy and window

fogging may occur. Extended use of this mode is not recommended.

On systems with Manual Climate Controls, the Recirculation mode is not allowed in Defrost mode to improve window cleaning operation. Recirculation is disabled automatically if this mode is selected. Attempting to use Recirculation while in this mode causes the LED in the control button to blink and then turn off.

Front Defrost Setting



Turn the mode control knob to the Front Defrost mode setting. Air comes from the windshield and side window demist outlets. When the defrost button is selected, the blower level may increase. Use Defrost mode with maximum temperature settings for best windshield and side window defrosting and defogging.

Rear Defrost Button



Push and release the Rear Defrost Control button to turn on the rear window defroster and the heated outside mirrors (if equipped). The Rear Defrost indicator illuminates when the rear window defroster is on. The rear window defroster automatically turns off after 10 minutes.

CAUTION!

Failure to follow these cautions can cause damage to the heating elements:

- Use care when washing the inside of the rear window. Do not use abrasive window cleaners on the interior surface of the window. Use a soft cloth and a mild washing solution, wiping parallel to the heating elements. Labels can be peeled off after soaking with warm water.
- Do not use scrapers, sharp instruments, or abrasive window cleaners on the interior surface of the window.
- Keep all objects a safe distance from the window.

Temperature Control

Temperature Control regulates the temperature of the air forced through the climate system.



The temperature increases as you turn the temperature control knob clockwise.



The temperature decreases as you turn the temperature control knob counterclockwise.

Blower Control



Blower Control regulates the amount of air forced through the climate control system. There are seven blower speeds available. The blower speed increases as you turn the

blower control knob clockwise from the lowest blower setting. The blower speed decreases as you turn the blower control knob counterclockwise.

Mode Control



Turn the mode control knob or press the mode control button (if equipped) to adjust airflow distribution. The airflow distribution mode can be adjusted so air comes from the instrument panel outlets, floor outlets, defrost outlets and demist outlets.

Panel Mode



Air comes from the outlets in the instrument panel. Each of these outlets can be individually adjusted to direct the flow of air. The air vanes of the center outlets and outboard outlets can be moved up and down or side to side to regulate airflow direction. There is a shut-off wheel located below the air vanes to shut off or adjust the amount of airflow from these outlets.

Bi-Level Mode



Air comes from the instrument panel outlets and floor outlets. A slight amount of air is directed through the defrost and side window demister outlets.

NOTE:

Bi-Level mode is designed under comfort conditions to provide cooler air out of the panel outlets and warmer air from the floor outlets.

Floor Mode



Air comes from the floor outlets. A slight amount of air is directed through the defrost and side window demister outlets.

Mix Mode



Air is directed through the floor, defrost, and side window demister outlets. This setting works best in cold or snowy conditions that require extra heat to the windshield. This setting is good for maintaining comfort while reducing moisture on the windshield.

AUTOMATIC TEMPERATURE CONTROL (ATC) — IF EQUIPPED

Automatic Operation

1. Push the AUTO button on the faceplate, or the AUTO button on the touchscreen on the Automatic Temperature Control (ATC) Panel.
2. Next, adjust the temperature that you would like the system to maintain by adjusting the driver and passenger temperature control buttons. Once the desired temperature is displayed, the system will achieve and automatically maintain that temperature.
3. When the system is set up for your comfort level, it is not necessary to change the settings. You will experience the greatest efficiency by simply allowing the system to function automatically.

NOTE:

- It is not necessary to move the temperature settings for cold or hot vehicles. The system automatically adjusts the temperature, mode, and blower speed to provide comfort as quickly as possible.
- The temperature can be displayed in US or Metric units by selecting the US/Metric customer-programmable feature within Uconnect Settings ➞ page 227.

To provide you with maximum comfort in the Automatic mode during cold start-ups, the blower fan will remain on low until the engine warms up. The blower will increase in speed and transition into Auto mode.

Manual Operation Override

This system offers a full complement of manual override features. The AUTO symbol in the front ATC display will be turned off when the system is being used in the manual mode.

CLIMATE VOICE RECOGNITION — IF EQUIPPED

Adjust vehicle temperatures hands-free and keep everyone comfortable while you keep moving ahead.

Push the VR button on the steering wheel. After the beep, say one of the following commands:

- “Set driver temperature to [Desired Temperature] degrees”
- “Set passenger temperature to [Desired Temperature] degrees”

Voice Command for Climate may only be used to adjust the interior temperature of your vehicle. Voice

Command will not work to adjust the heated seats or steering wheel if equipped.

OPERATING TIPS

Refer to the chart at the end of this section for suggested control settings for various weather conditions.

Summer Operation

The engine cooling system must be protected with a high-quality antifreeze coolant to provide proper corrosion protection and to protect against engine overheating. OAT coolant (conforming to MS.90032) is recommended.

Winter Operation

To ensure the best possible heater and defroster performance, make sure the engine cooling system is functioning properly and the proper amount, type, and concentration of coolant is used. Use of the Air Recirculation mode during Winter months is not recommended, because it may cause window fogging.

Vacation/Storage

For information on maintaining the Climate Control system when the vehicle is being stored for an extended period of time, see ➞ page 406.

Window Fogging

Vehicle windows tend to fog on the inside in mild, rainy, and/or humid weather. To clear the windows, select Defrost or Mix mode and increase the front blower

speed. Do not use the Recirculation mode without A/C for long periods, as fogging may occur.

Outside Air Intake

Make sure the air intake, located directly in front of the windshield, is free of obstructions, such as leaves. Leaves collected in the air intake may reduce airflow, and if they enter the air distribution box, they could plug the water drains. In Winter months, make sure the air intake is clear of ice, slush, and snow.

Cabin Air Filter





The Climate Control system filters out dust and pollen from the air. Contact an authorized dealer to service your cabin air filter, and to have it replaced when needed.

Stop/Start System — If Equipped

While in an Autostop, the Climate Control system may automatically adjust airflow to maintain cabin comfort. Customer settings will be maintained upon return to an engine running condition.

Operating Tips Chart

WEATHER	CONTROL SETTINGS
Hot Weather And Vehicle Interior Is Very Hot	Set the mode control to  (Panel Mode), Δ C (A/C) on, and blower on high. Roll down the windows for a minute to flush out the hot air. Adjust the controls as needed to achieve comfort.

WEATHER	CONTROL SETTINGS
Warm Weather	Turn Δ C (A/C) on and set the mode control to  (Panel Mode).
Cool Sunny	Operate in  (Bi-Level Mode).
Cool & Humid Conditions	Set the mode control to  (Floor Mode) and turn Δ C (A/C) on to keep windows clear.
Cold Weather	Set the mode control to  (Floor Mode). If windshield fogging starts to occur, move the control to  (Mix Mode).

INTERIOR STORAGE AND EQUIPMENT

STORAGE

Glove Compartment

The glove compartment is located on the passenger side of the instrument panel and features both an upper and lower storage area.

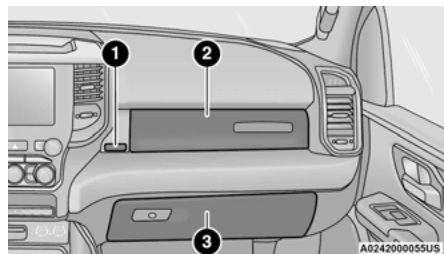

Glove Compartment

- 1 — Upper Glove Compartment Release Button (If Equipped)
- 2 — Upper Glove Compartment
- 3 — Lower Glove Compartment

If equipped with a covered upper glove compartment, push the release button to open.

To open the lower glove compartment, pull the release handle.

WARNING!

Do not operate this vehicle with a glove compartment in the open position. Driving with the glove compartment open may result in injury in a collision.

Door Storage — If Equipped

Front Door Storage

Storage areas are located in the door trim panels.

Rear Door Storage

Storage areas are located in the door trim panels.

Center Storage Compartment – If Equipped

The center storage compartment is located between the driver and passenger seats. The storage compartment provides an armrest and contains both an upper and lower storage area.

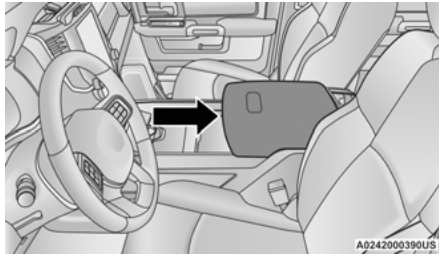

Center Storage Compartment

WARNING!

- This armrest is not a seat. Anyone seated on the armrest could be seriously injured during vehicle operation, or a collision.
- In a collision, the latch may open if the total weight of the items stored exceeds about 10 lb (4.5 kg). These items could be thrown about endangering occupants of the vehicle. Items stored should not exceed a total of 10 lb (4.5 kg).

Pull on the upper handle on the front of the armrest to raise the cover. The upper storage area contains a USB power outlet that can be used to power small electrical devices.

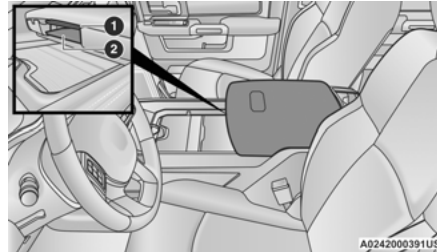

Center Storage Compartment

- 1 – Upper Console Handle
- 2 – Lower Console Handle

With the upper lid closed, pull on the lower handle to open the lower storage bin. The lower bin contains a power inverter. There is also a fill line located along the rear inside wall of the lower bin. Contents above the fill line may interfere with cupholder placement if equipped with a premium center console.

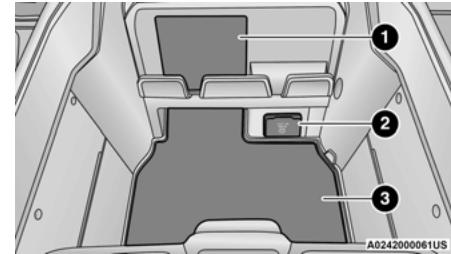

Forward Portion Of Lower Storage Bin

- 1 – Wireless Charging Pad
- 2 – Power Inverter
- 3 – Storage Area

WARNING!

Do not operate this vehicle with a console compartment lid in the open position. Driving with the console compartment lid open may result in injury in a collision.

Premium Center Console – If Equipped

The premium center console is equipped with two front storage bins located in front of the center storage compartment. These storage bins may be equipped with tandem doors. Push the front bin to access the cupholders. Or push the rear bin to access the coin holder/small storage bin.

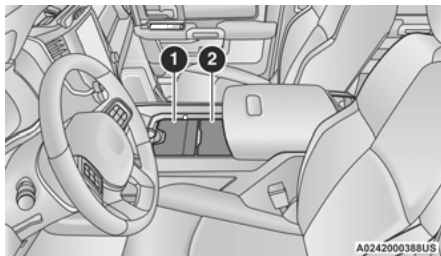

Center Console Tandem Doors— If Equipped

- 1 — Push Front Bin Access
- 2 — Push Rear Bin Access

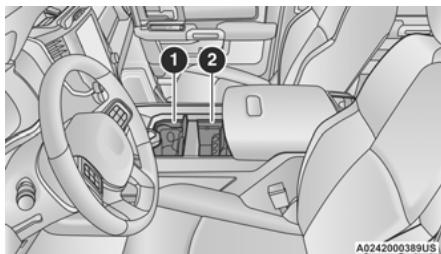

Tandem Doors Open Position

- 1 — Front Bin Open
- 2 — Rear Bin Open

Push the release button at the front of the cupholder bin to slide tray rearward to access the front lower storage bin, or forward to access the rear lower storage bin.

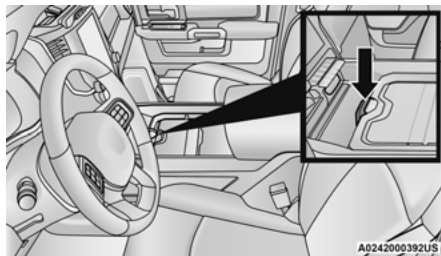

Push Release Button To Slide Tray

Center Console Storage Area — RHO Only

The center console storage area consists of a cubby bin (located in front of the gear selector) and two cupholders (located to the right of the gear selector). If equipped with a wireless charging pad, it will be located within the cubby bin.

To access the cupholders, push on the cover to open it.

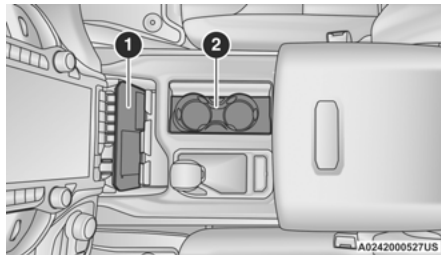

Center Console Storage Area

- 1 — Cubby Bin (With Wireless Charging Pad)
- 2 — Cupholders

NOTE:

The metal badge on the top of the center console lid will get hot to the touch if the console lid is exposed to direct sunlight, or if the vehicle is exposed to an extremely high temperature environment.

Overhead Sunglass Storage

At the front of the overhead console, a compartment is provided for the storage of one pair of sunglasses.

From the closed position, push the door latch to open the compartment.

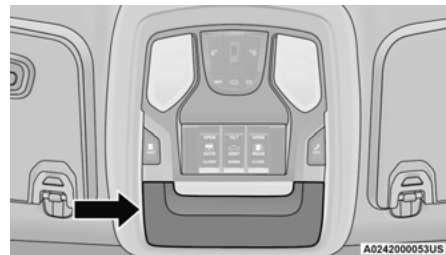

Overhead Sunglass Door

Front Bench Seat Storage — If Equipped

If your vehicle is equipped with a front bench seat, storage can be found by folding down the center seatback. A console storage area and cupholders are available.

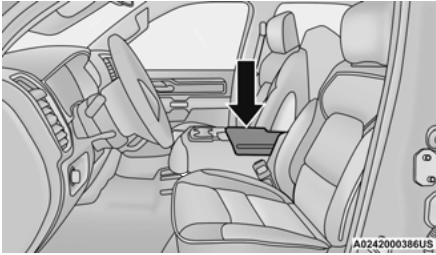

Front Bench Seat Storage

With the seatback in the upright position, lift the center seat bottom to access additional storage underneath the seat.

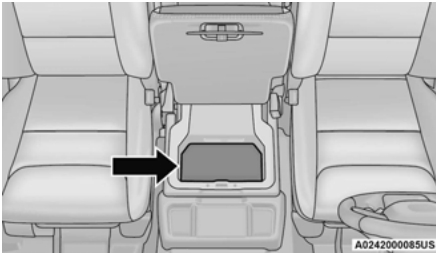

Below Seat Bottom Storage

Rear Console Storage — If Equipped

The center portion of the 40/20/40 rear seat will fold forward for rear seat cupholders and a storage

compartment. Lift up on the console latch to access the storage compartment.

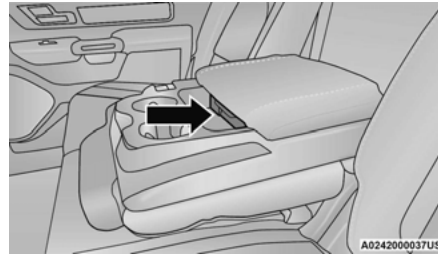

Rear Console Latch Location

Seatback Storage

Located in the back of both the driver and passenger front seats are pockets that can be used for storage.

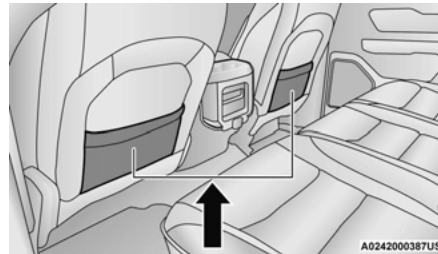

Seatback Storage

Second Row In-Floor Storage Bin — If Equipped

In-floor storage bins are located in front of the second row seats and can be used for extra storage. The storage bins have removable liners that can be easily removed for cleaning.

To open the in-floor storage bin, lift upward on the handle of the latch and open the lid.

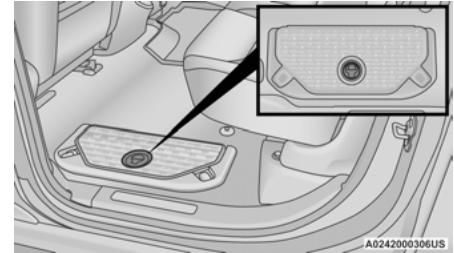

In-Floor Storage Bin Latch

NOTE:

The front seat may have to be moved forward to fully open the lid.

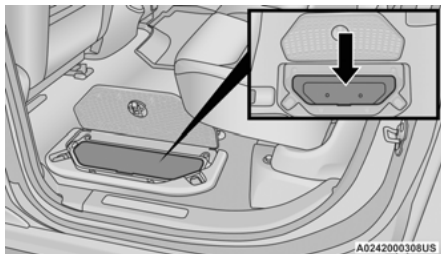

Opened Storage Bin

Each storage bin also contains two hooks for securing cargo. These hooks should be used to secure loads safely when the vehicle is moving.

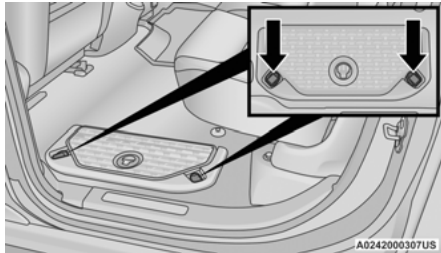

In-Floor Storage Bin Hooks

NOTE:

The maximum load limit for each hook is 250 lb (113 kg).

Storage Under Rear Seat – If Equipped

To access the storage under the rear seats, unlatch the lock mechanism in the center of the seat base by rotating it to either side, and fold the front of the seat base forward.

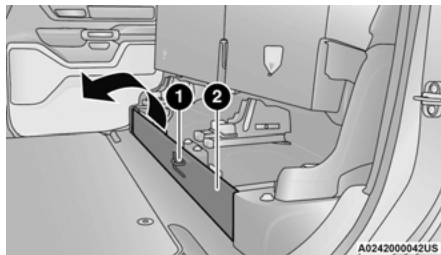

Folding Down Front Of Seat Base

- 1 – Lock Mechanism
- 2 – Front Of Seat Base

Flip the inside of the base upward into the upright position, locking into place, creating an extended storage area.

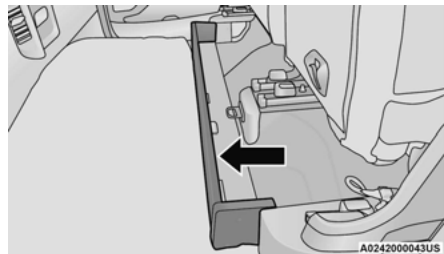

Fully Extended Storage Area

NOTE:

The rear seats do not need to be folded up to access this feature.

USB/AUX CONTROL

Located on the center stack, just below the instrument panel, is the main media hub. There may be four total USB ports: Two Mini-USBs (Type C) and two Standard USBs (Type A). There is also an AUX port located in the middle of the USB ports. For vehicles equipped with a passenger screen, an additional Mini-USB, Standard USB and HDMI port will be included.

Plugging in a smartphone device to a USB port may activate Android Auto™ or Apple CarPlay® features, if equipped. For further information, refer to “Android Auto™” or “Apple CarPlay®” in the Uconnect Radio Instruction Manual.

NOTE:

Two devices can be plugged in at the same time, and both ports will provide charging capabilities. Only one

port can transfer data to the system at a time. A pop-up will appear and allow you to select the device transferring data.

For example, if a device is plugged into the Type A USB port and another device is plugged into the Type C USB port, a message will appear and allow you to select which device to use.

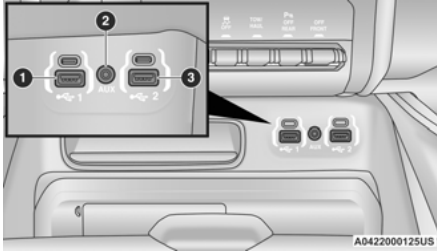

Center Stack USB/AUX Media Hub

- 1 – Standard USB Type A Port #1
- 2 – AUX Port
- 3 – Standard USB Type A Port #2

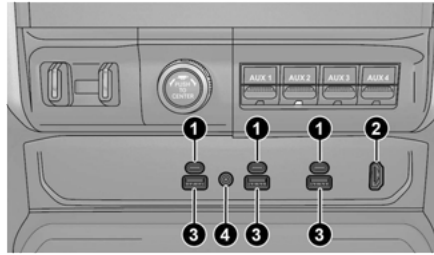

Center Stack USB/AUX Media Hub with Passenger Screen (If Equipped)

- 1 – USB C Port
- 2 – HDMI Port
- 3 – USB A Port
- 4 – AUX Port

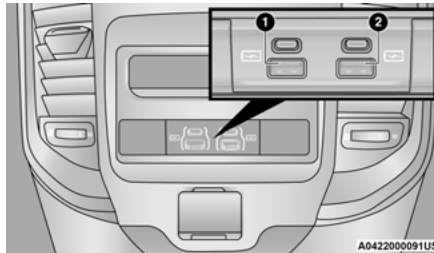

Rear USB Ports

- 1 – Rear Charge Only USB Ports 1
- 2 – Rear Charge Only USB Ports 2

The third and fourth USB ports are located behind the center console, above the power inverter. Both are charge only.

Applicable to only Uconnect 5/5 NAV With 8.4-inch Display, and Uconnect 5 NAV With 12-inch Display radios, different scenarios are listed as follows when a non-phone device is plugged into the smaller and larger USB ports, and when a phone device is plugged into the smaller and larger USB ports:

- “A new device is now connected. Previous connection was lost”.
- “(Phone Name) now connected. Previous connection was lost”.
- “Another device is in use through the same USB port. Please disconnect the first device to use the second device”.

NOTE:

Charge unsupported devices with the Charge Only USB ports. If an unsupported device is plugged into a Media USB port, a message will display on the touchscreen that the device is not supported by the system.

Plugging in a phone or another USB device may cause the connection to a previous device to be lost.

If equipped, your vehicle may also contain a USB port located in the upper tray of the vehicle’s center console.

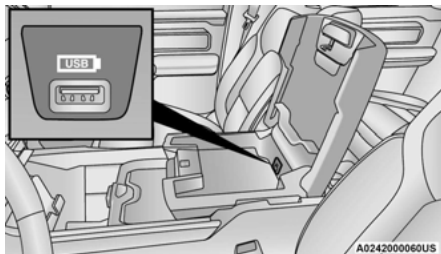

Upper Storage USB Outlet

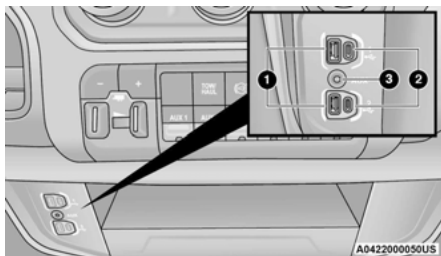

Center Console USB/AUX Media Hub

- 1 — Standard USB Type A Ports
- 2 — Mini-USB Type C Ports
- 3 — AUX Port

If equipped, two Mini-USB ports (Type C), two Standard USB ports (Type A), and one AUX port may be located to the left of the center stack, just below the climate controls.

Some USB ports support media and charging. You can use features, such as Apple CarPlay®, Android Auto™, Pandora®, and others while charging your phone.

NOTE:

Plugging in a phone or another USB device may cause the connection to a previous device to be lost.

For further information, refer to the Uconnect Radio Instruction Manual or visit UconnectPhone.com.

ELECTRICAL POWER OUTLETS

The auxiliary 12 Volt (13 Amp) power outlet can provide power for in-cab accessories designed for use with the standard “cigarette lighter” style plug. The 12 Volt power outlets and 5 Volt (2.5 Amp) USB Port (Charge Only) have a cap attached to the outlet indicating “12V DC”, together with either a key symbol, battery symbol, or USB symbol.

CAUTION!

- Do not exceed the maximum power of 160 Watts (13 Amps) at 12 Volts. If the 160 Watts (13 Amps) power rating is exceeded, the fuse protecting the system will need to be replaced.
- Power outlets are designed for accessory plugs only. Do not insert any other object in the power outlets as this will damage the outlet and blow the fuse. Improper use of the power outlet can cause damage not covered by your New Vehicle Limited Warranty.

An auxiliary power outlet can be found in the tray on top of the center stack. This power outlet works when the ignition is in the ON/RUN or OFF position.

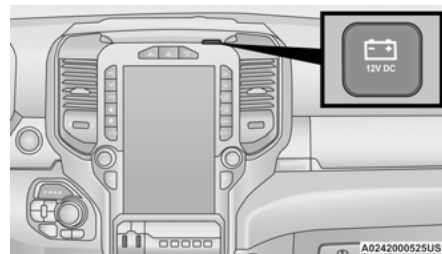

Power Outlet — Top Of Center Stack

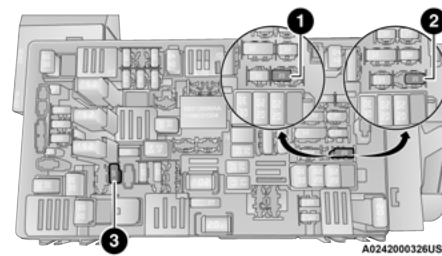

Power Outlet Fuse Locations

- 1 — F54 Fuse 20 A Yellow Power Outlet Battery Fed Position
- 2 — F54 Fuse 20 A Yellow Power Outlet Ignition Fed Position
- 3 — F62 Fuse 10 A Red Port Power or Rear USB (Charge Only)

When the vehicle is turned off, be sure to unplug any equipment as to not drain the battery of the vehicle.

All accessories connected to the outlet(s) should be removed or turned off when the vehicle is not in use to protect the battery against discharge.

WARNING!

To avoid serious injury or death:

- Only devices designed for use in this type of outlet should be inserted into any 12 Volt outlet.
- Do not touch with wet hands.
- Close the lid when not in use and while driving the vehicle.
- If this outlet is mishandled, it may cause an electric shock and failure.

CAUTION!

- Many accessories that can be plugged in draw power from the vehicle's battery, even when not in use (i.e., cellular phones, etc.). Eventually, if plugged in long enough, the vehicle's battery will discharge sufficiently to degrade battery life and/or prevent the engine from starting.
- Accessories that draw higher power (i.e., coolers, vacuum cleaners, lights, etc.), will discharge the battery even more quickly. Only use these intermittently and with greater caution.
- After the use of high power draw accessories, or long periods of the vehicle not being started (with accessories still plugged in), the vehicle must be driven a sufficient length of time to allow the generator to recharge the vehicle's battery.

POWER PANEL — IF EQUIPPED

The Power Panel enables the transfer of energy to power 120V AC items.

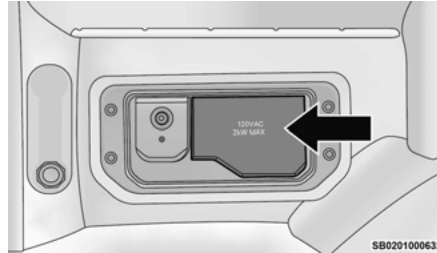

Power Panel

Please read all Cautions and Safety procedures within these Power Panel instructions before operating.

NOTE:

- For vehicles with "e-torque", the vehicle must be in PARK to use the Power Panel. If the vehicle is shifted out of PARK while the Power Panel is in use, a message will display on the Uconnect System, and the Power Panel will shut off. Non-essential functions (Uconnect Systems, Heated Seats, etc.) may be turned off while using the Power Panel.
- Vehicles with "e-torque" will have access to Generator Mode.
- While using the Power Panel, vehicles without "e-torque" will have limitations.
- Attempting to use or access the Power Panel App while the vehicle is in motion will display "Feature

Unavailable While The Vehicle Is In Motion" in the Uconnect System.

- The vehicle must be running for the Power Panel to function.

The Power Panel will have produce 2 kilowatts at peak power with 1750 watts while stationary.

For vehicles equipped with "e-torque", the Power Panel can produce 750W from the outlets while driving.

WARNING!

To avoid serious injury or death:

- Do not insert any objects into the receptacles.
- Do not touch with wet hands.
- Close the lid when not in use.
- If this outlet is mishandled, it may cause an electric shock and failure.

Accessing The Power Panel App From the Uconnect System

NOTE:

Vehicles equipped with a Uconnect 5 with 8.4-inch radio will not have a Power Management app. The Power Panel can be turned On from the switch at the outlet.

To use the power panel, plug a device into the Panel outlet, located in the truck bed and/or front of the vehicle. The Power Panel can be turned on via the switch at the Outlet or from the Uconnect System using the Power Management App.

The Power Panel App can be accessed from the Uconnect System:

1. Press the "Vehicle" button on the touchscreen and select Dashboard.
2. Select "Power Management".

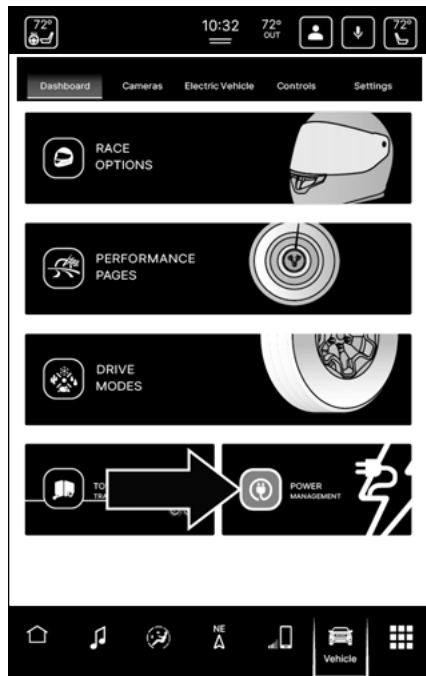

Power Management Select Screen

NOTE:

If any of the available modes are not available, they will gray out, state they are unavailable, and not be selectable.

Power Management Screen

The Power Management Screen will allow you to view the status of your Power Panel, which outlets are available, and the amount of charge available on the vehicle.

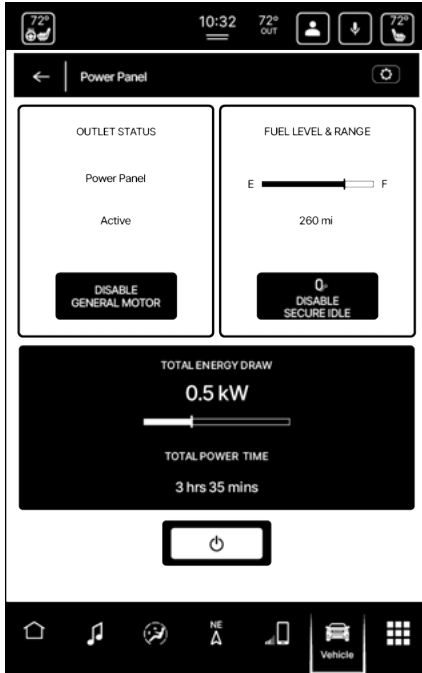

Power Management Screen

Information Button

On the Power Management page, an information icon is available to press. An information pop-up will display

and explain the purpose of the Power Panel and show the positions of the outlets.

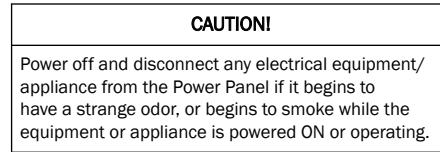

Turning The Power Panel Outlets On And Off

The Power Panel outlets can be turned on and off from two locations: the Uconnect system and the hard button on the vehicle.

The vehicle must be running for the Power Panel outlets to function. Pressing them On/Off" button will turn the Power Panel on or off. When on, the vehicle will enter Generator Mode. Pushing the On/Off button again will turn off the Power Panel, and the vehicle will exit Generator Mode. Generator Mode will disable all nonessential functions of the vehicle. A pop up will display stating "Vehicle Is Running".

The screen provides information related to vehicle charge and outlet status. The information provided is shown below:

- **Outlet Status:** Shows the current status of the Power Panel outlets (Active or Unavailable).
- **Total Power Time:** Shows the amount of time the Power Panel outlets can supply power. Days, Hours, and Minutes will only display on the EV version of the vehicle.

- **Total/Instant Energy Draw:** Shows the amount of power being drained from the vehicle.
- **Fuel Level & Range:** Shows the amount of fuel charge left in the vehicle.

When fuel level is low, the pop-up "Low Fuel Level" will display.

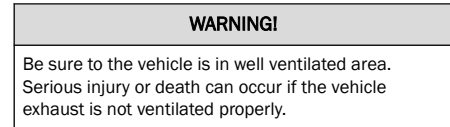

Power Panel Settings

On the Power Management Screen, press the Setting Gear icon in the upper right of the touchscreen. The following settings are available.

Setting Name	Description
Visual Warning	This setting will enable or disable visual warnings of Power Panel usage.
Audible Warning	This setting will enable or disable audio warnings of Power Panel usage.

POWER INVERTER — IF EQUIPPED

A 115 Volt (400 Watts maximum) inverter may be located inside the center console towards the right hand side. This inverter can power cellular phones,

electronics and other low power devices requiring power up to 400 Watts. Certain video game consoles exceed this power limit, as will most power tools.

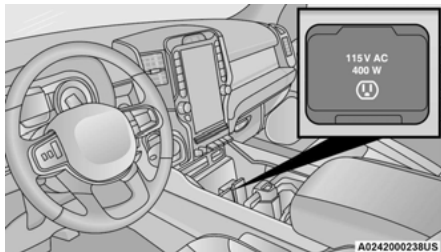

Center Console Power Inverter Outlet

NOTE:

For RHO Models: A 115 Volt (400 Watt maximum) inverter may be located inside the center console storage area. This inverter can power cellular phones, electronics and other low-power devices requiring power up to 400 Watts. Certain video game consoles exceed this power limit, as will most power tools. The outlet remains off when no device is plugged in. To turn on the power outlet, simply plug in a device.

There is also a second 115 Volt (400 Watts maximum) power inverter located on the rear of the center console. This inverter can power cellular phones, electronics and other low power devices requiring power up to 400 Watts. Certain video game consoles exceed this power limit, as will most power tools.

All power inverters are designed with built-in overload protection. If the power rating of 400 Watts is exceeded, the power inverter shuts down. Once the

electrical device has been removed from the outlet the inverter should reset.



Rear Center Console Power Inverter Outlet

NOTE:

400 Watts is the maximum for the inverter, not each outlet. If three outlets are in use, 400 Watts is shared amongst the devices plugged in.

If equipped with a front bench seat, there may be a 115 Volt (400 Watts maximum) inverter located to the right of the center stack, just below the climate controls. This inverter can power cellular phones, electronics and other low power devices requiring power up to 400 Watts. Certain video game consoles exceed this power limit, as will most power tools.

To turn on the power outlet, simply plug in a device. The outlet turns off when the device is unplugged.

NOTE:

- The Center Stack Power Inverter is only available on vehicles equipped with a front bench seat.
- The power inverter only turns on if the ignition is in the ON/RUN position.

- Due to built-in overload protection, the power inverter shuts down if the power rating is exceeded.

WARNING!

To avoid serious injury or death:

- Do not insert any objects into the receptacles.
- Do not touch with wet hands.
- Close the lid when not in use.
- If this outlet is mishandled, it may cause an electric shock and failure.

WIRELESS CHARGING PAD — IF EQUIPPED



Wireless Charging Pad (Single)

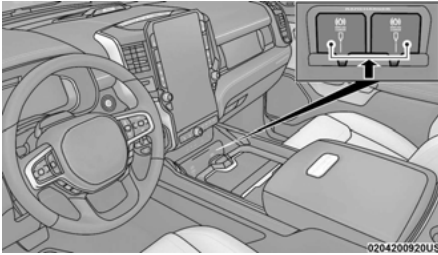

Wireless Charging Pad (Dual)

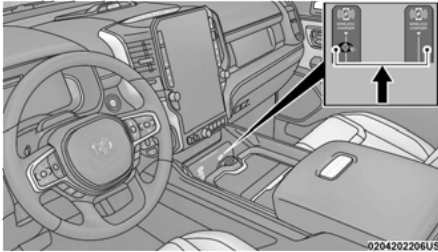

Wireless Charging Pad (Dual with NFC)

NOTE:

For vehicles equipped with NFC capabilities, the wireless charging pad on the left includes a NFC transceiver which is used for NFC tap access and start functionality → page 422. The wireless charging pad on the right does not include a NFC transceiver.

Your vehicle may be equipped with a single or dual 15W 3A Qi® wireless charging pad located below the center

stack, within the storage compartment. This charging pad is designed to wirelessly charge your Qi® enabled mobile phone. Qi® is a standard that allows wireless charging of your mobile phone.

Your mobile phone must be designed for Qi® wireless charging. If the phone is not equipped with Qi® wireless charging functionality, an aftermarket sleeve or a specialized back plate can be purchased from your mobile phone provider or a local electronics retailer. Please see your phone's Owner's Manual for further information.

Place the device inside the prepared area delimited in the mat as shown in the image. Incorrect positioning will prevent the phone from charging.

NOTE:

If your vehicle comes with a Wireless Charging pad, you'll notice a clear indication on the rubber mat with the text "Wireless Charger" and accompanying phone and charging icon graphics. The charger is available on the left side for single charging pads, and on the left and right side for dual charging pads.

Alternatively, if you have a phone holder in your vehicle, it has a rubber surface with textured grip for secure placement, and a designated slot for your charging cord.

LED Indicator Status:

- No Light: Charging pad is idle or searching for a device, or Device may not be compatible with the Qi® standard.
- Blue Light: Device is detected and is charging.

- Red Light/Flashing: Internal error, or foreign object is detected.
- Green Light: Device has completed battery charging (if device is equipped to transmit this information).

Important Notes Regarding This Vehicle's Wireless Charging Pad:

- The presence of the Near-Field Communication (NFC) function active on a smartphone could signal malfunction anomalies.
- The vehicle must be in the ON/RUN position and all doors are closed in order for the phone to charge.
- To avoid interference with the key fob search, the wireless charging pad will stop charging when any door or liftgate is opened, even if the vehicle is running.
- Be sure to place the mobile device correctly (display facing upward, and phone not covering the LED) on the wireless charging pad.
- If the phone moves on the pad causing the red light to illuminate, the phone will have to be picked up and placed back on the charging pad to resume charging.
- Wireless charging is not as fast as when the phone is connected to a wired charger.
- Some phone's protective case may impact charging. If a phone is not charging due to thick or not certified phone case, it is recommended to remove the phone case before placing on the wireless charging pad.

- iPhones® equipped with Magsafe® may affect the charging function, and may cause higher phone temperature.
- Phones must always be placed on the wireless charging pad within the outline shown on the pad so that its charging parts connect with the charging coils of the system. Movement of the phone during charging may prevent or slow the rate of charge.
- Having multiple applications open on the phone while charging may cause the phone to overheat and will reduce the charging rate, and may even shut down an application that is actively running (i.e. Android Auto™ or Apple CarPlay®).
- The charging rate may slow down or stop to prevent the phone from overheating. If this happens, it does not mean there is a fault with the wireless charging pad. This may just be a protective measure requested by the phone to prevent damage.
- The use of multiple wireless functions at the same time (wireless charging, Apple CarPlay®, Android Auto™) could cause the device to overheat, resulting in limitation of the functions or it turning off. In this case, it is recommended to connect the system using the USB port.
- Do not place the key fob or any other type of metal/ magnetized object in the phone case or near the wireless charging pad.

CAUTION!

The key fob should not be placed on the charging pad or within 6 inches (15 cm) of it. Doing so can

(Continued)

CAUTION!

cause excessive heat buildup and damage to the fob. Placing the fob in close proximity of the charging pad blocks the fob from being detected by the vehicle and prevents the vehicle from starting.

To prevent malfunction or burns:

- Do not insert any metallic materials (such as Coins, Keys, Metal Cards, Paper Clips) or Key Card between the charging pad and the phone while charging.
- Do not attach metallic materials (such as aluminum sticker) to the device side placing the charging area.

WINDOWS**POWER WINDOWS**

The window controls on the driver's door control all the door windows.

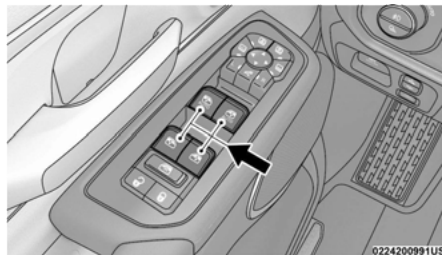
**Power Window Switches**

The passenger door windows can also be operated by using the single window controls on the passenger door trim panel. The window controls will operate only when the ignition is in the ON/RUN position.

To open the window part way (manually), push the window switch down briefly and release.

NOTE:

The power window switches will remain active for up to 10 minutes after the ignition is placed in the OFF position. Opening either front door will cancel this feature. The time is programmable within Uconnect Settings ➞ page 227.

WARNING!

Never leave children unattended in a vehicle. Do not leave the key fob in or near the vehicle or in a location accessible to children, and do not leave the Keyless Enter 'n Go™ Ignition in the ACC or ON/RUN position. Occupants, particularly unattended

(Continued)

WARNING!

children, can become entrapped by the windows while operating the power window switches. Such entrapment may result in serious injury or death.

AUTOMATIC WINDOW FEATURES**Auto-Down Feature**

The driver and front passenger door power window switches have an Auto-Down feature. Push the window switch down for a short period of time, then release, and the window will go down automatically.

To stop the window from going all the way down during the Auto-Down operation, pull up or push down on the switch briefly.

Auto-Up Feature With Anti-Pinch Protection

Lift the window switch up for a short period of time and release; the window will go up automatically.

To stop the window from going all the way up during the Auto-Up operation, push down on the switch briefly.

To close the window part way, lift the window switch briefly and release it when you want the window to stop.

If the window runs into any obstacle during auto-closure, it will reverse direction and then go back down. Remove the obstacle and use the window switch again to close the window.

NOTE:

Any impact due to rough road conditions may trigger the auto-reverse function unexpectedly during auto-closure. If this happens, pull the switch lightly and hold to close the window manually.

WARNING!

There is no anti-pinch protection when the window is almost closed. To avoid personal injury be sure to clear your arms, hands, fingers and all objects from the window path before closing.

RESET AUTO-UP

Should the Auto-Up feature stop working, the window probably needs to be reset. To reset Auto-Up:

1. Pull the window switch up to close the window completely and continue to hold the switch up for an additional two seconds after the window is closed.
2. Push the window switch down firmly to open the window completely and continue to hold the switch down for an additional two seconds after the window is fully open.

WINDOW LOCKOUT SWITCH

The window lockout switch on the driver's door trim panel allows you to disable the window controls on the rear passenger doors. To disable the window controls, push and release the window lockout button (the indicator light on the button will turn on). To enable the window controls, push and release the window lockout button again (the indicator light on the button will turn off).

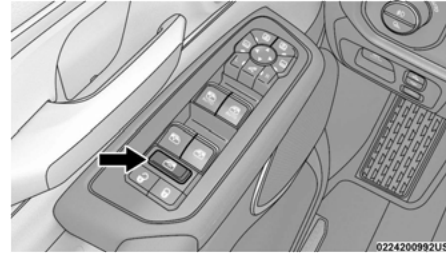
**Window Lockout Switch****POWER SLIDING REAR WINDOW — If EQUIPPED**

The switch for the power sliding rear window is located on the overhead console. Push the switch rearward to open the glass. Push the switch forward to close the glass.

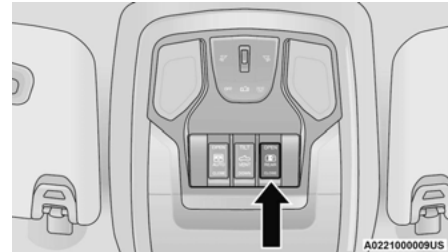
**Rear Window Switch**

WIND BUFFETING

Wind buffeting can be described as the perception of pressure on the ears or a helicopter-type sound in the ears. Your vehicle may exhibit wind buffeting with the windows down, or the sunroof (if equipped) in certain open or partially open positions. This is a normal occurrence and can be minimized. If the buffeting occurs with the rear windows open, open the front and rear windows together to minimize the buffeting. If the buffeting occurs with the sunroof open, adjust the sunroof opening to minimize the buffeting or open any window.

POWER SUNROOF — IF EQUIPPED

SINGLE PANE POWER SUNROOF

The power sunroof switches are located on the overhead console between the courtesy/reading lights.

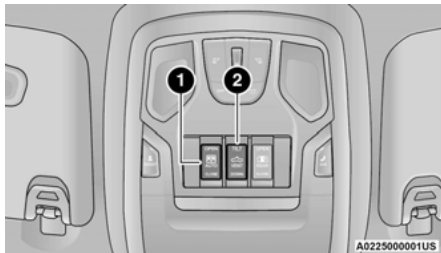

Power Sunroof Switches

- 1 — Opening/Closing Sunroof
- 2 — Venting Sunroof

WARNING!

- Never leave children unattended in a vehicle, or with access to an unlocked vehicle. Never leave the key fob in or near the vehicle, or in a location accessible to children. Do not leave the Keyless Enter 'n Go™ Ignition in the ACC or ON/RUN position. Occupants, particularly unattended children, can become entrapped by the power sunroof while operating the power sunroof switch. Such entrapment may result in serious injury or death.
- In a collision, there is a greater risk of being thrown from a vehicle with an open sunroof. You could also be seriously injured or killed. Always fasten your seat belt properly and make sure all passengers are also properly secured.
- Do not allow small children to operate the sunroof. Never allow your fingers, other body parts, or any object, to project through the sunroof opening. Injury may result.

Opening And Closing The Sunroof

Express Open/Close

Push the switch rearward and release it within one-half second and the sunroof will open automatically from any position. The sunroof will open fully and stop automatically.

Push the switch forward and release it within one-half second and the sunroof will close automatically from

any position. The sunroof will close fully and stop automatically.

During Express Open or Express Close operation, any other movement of the sunroof switch will stop the sunroof.

Manual Open/Close

To open the sunroof, push and hold the switch rearward to full open.

To close the sunroof, push and hold the switch in the forward position.

Any release of the switch during open or close operation will stop the sunroof movement. The sunroof will remain in a partially opened position until the switch is operated and held again.

NOTE:

If the sunshade is in the closed position when Express or Manual Open operation is initiated the sunshade will automatically open to the half open position prior to the sunroof opening.

Pinch Protect Feature

This feature will detect an obstruction in the opening of the sunroof during Express Close operation. If an obstruction in the path of the sunroof is detected, the sunroof will automatically retract. Remove the obstruction if this occurs.

NOTE:

If three consecutive sunroof close attempts result in Pinch Protect reversals, Pinch Protect will disable and the sunroof must be closed in Manual Mode.

Venting Sunroof

Push and release the Vent button within one half second and the sunroof will open to the vent position. This is called “Express Vent”, and it will occur regardless of sunroof position. During Express Vent operation, any other actuation of the switch will stop the sunroof.

Sunshade Operation

The sunshade can be opened manually. However, the sunshade will open automatically as the sunroof opens.

NOTE:

The sunshade cannot be closed if the sunroof is open.

Ignition Off Operation

The power sunroof switch will remain active for up to approximately 10 minutes after the ignition switch is placed in the OFF position. Opening either front door will cancel this feature.

NOTE:

Ignition Off timing is programmable through the Uconnect system → page 227.

Sunroof Maintenance

Use only a non-abrasive cleaner and a soft cloth to clean the glass panel. Periodically check for and clear out any debris that may have collected in the tracks.

DUAL PANE POWER SUNROOF

The power sunroof switches are located on the overhead console between the courtesy/reading lights.

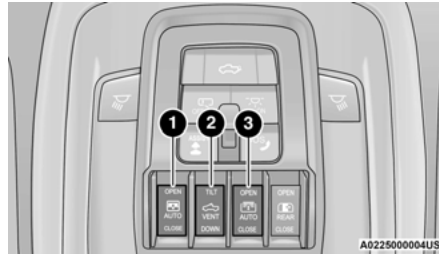

Power Sunroof Switches

- 1 — Opening/Closing Sunroof
- 2 — Venting Sunroof
- 3 — Opening/Closing Sunshade

WARNING!

- Never leave children unattended in a vehicle, or with access to an unlocked vehicle. Never leave the key fob in or near the vehicle, or in a location accessible to children. Do not leave the Keyless Enter 'n Go™ Ignition in the ACC or ON/RUN position. Occupants, particularly unattended children, can become entrapped by the power sunroof while operating the power sunroof switch. Such entrapment may result in serious injury or death.
- In a collision, there is a greater risk of being thrown from a vehicle with an open sunroof. You could also be seriously injured or killed. Always

(Continued)

WARNING!

fasten your seat belt properly and make sure all passengers are also properly secured.

- Do not allow small children to operate the sunroof. Never allow your fingers, other body parts, or any object, to project through the sunroof opening. Injury may result.

2

Opening And Closing The Sunroof

The sunroof has two programmed automatic stops for the sunroof open position; a comfort stop position and a full open position. The comfort stop position has been optimized to minimize wind buffeting.

Express Open/Close

Push the switch rearward and release it within one-half second and the sunroof will open automatically from any position. The sunroof will open fully and stop automatically.

Push the switch forward and release it within one-half second and the sunroof will close automatically from any position. The sunroof will close fully and stop automatically.

During Express Open or Express Close operation, any other movement of the sunroof switch will stop the sunroof.

Manual Open/Close

To open the sunroof, push and hold the switch rearward to full open.

To close the sunroof, push and hold the switch in the forward position.

Any release of the switch during open or close operation will stop the sunroof movement. The sunroof will remain in a partially opened position until the switch is operated and held again.

NOTE:

If the sunshade is in the closed position when Express or Manual Open operation is initiated the sunshade will automatically open to the half open position prior to the sunroof opening.

Opening And Closing The Power Sunshade

The sunshade has two programmed positions: half open and full open positions. When operating the sunshade from the closed position, the sunshade will always stop at the half open position regardless of express or manual open operation. The switch must be actuated again to continue on to full open position.

If the sunroof is open or vented, the sunshade cannot be closed beyond the half open position. Pushing the sunshade close switch when the sunroof is open/vented and the sunshade is at half open position will first automatically close the sunroof prior to the sunshade closing.

Express Open/Close

Push the sunshade switch rearward and release it within one-half second, the sunshade will open to the half open position and stop automatically. Push and release the switch again from the half open position and the sunshade will open to the full open position and stop automatically.

Push the sunshade switch forward and release it within one-half second and the sunshade will close automatically.

During Express Open or Express Close operation, any other actuation of the sunroof switches will stop the sunshade in a partially open position.

Manual Open/Close

Push and hold the sunshade switch rearward, the sunshade will open to the half open position and stop automatically. Push and hold the sunshade switch again and the sunshade will open to the full open position.

Push and hold the switch forward and the sunshade will close and stop at full closed position.

Releasing the switch while the sunshade is in motion will stop the sunshade in a partially open position.

Pinch Protect Feature

This feature will detect an obstruction in the opening of the sunroof during Express Close operation. If an obstruction in the path of the sunroof is detected, the sunroof will automatically retract. Remove the obstruction if this occurs.

NOTE:

If three consecutive sunroof close attempts result in Pinch Protect reversals, Pinch Protect will disable and the sunroof must be closed in Manual Mode.

Venting Sunroof

Push and release the Vent button within one half second and the sunroof will open to the vent position. This is called "Express Vent" and it will occur regardless

of sunroof position. During Express Vent operation, any movement of the switch will stop the sunroof.

NOTE:

If the sunshade was not already open, it will automatically open prior to the roof opening to the vent position.

Ignition Off Operation

The power sunroof switch will remain active for up to approximately 10 minutes after the ignition switch is placed in the OFF position. Opening either front door will cancel this feature.

NOTE:

Ignition Off timing is programmable through the Uconnect system  page 227.

Sunroof Maintenance

Use only a non-abrasive cleaner and a soft cloth to clean the glass panel. Periodically check for and clear out any debris that may have collected in the tracks.

HOOD

To OPEN THE HOOD

To open the hood, two latches must be released.

1. Pull the hood release lever located below the steering wheel at the base of the instrument panel.

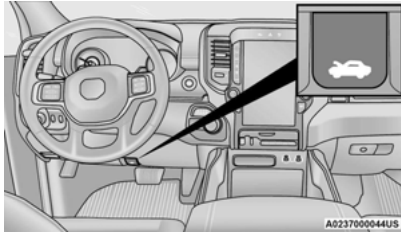

Hood Release Lever Location

2. Reach into the opening beneath the center of the hood and push the safety latch lever to the left to release it, before raising the hood.

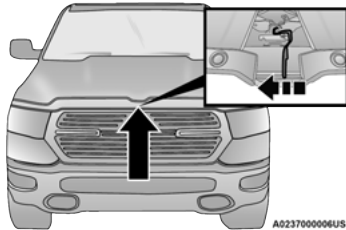

Safety Latch Location

NOTE:

- Vehicle must be at a stop and the gear selector must be in PARK.

- While lifting the hood, use both hands.
- Before lifting the hood, check that the wiper arms are not in motion and not in the lifted position.
- Pressing down on the hood may need to occur before pushing the safety latch. Use both hands while lifting the hood.

WARNING!

- Always place the start button in the OFF position before opening the hood.
- Some areas remain very hot for a while after driving or charging and may cause serious burns if touched.
- Keep hands, tools, clothing, and jewelry away from the radiator cooling fan when the hood is raised. The cooling fan may start operating at any time, including during charging. Hands or clothing caught in a rotating fan may cause serious injury.

To CLOSE THE HOOD

In one continuous motion, pull down on the front edge of the hood with moderate force until the angle is below the crossover point (where the gas props are no longer resisting) and let the hood continue to fall closed from its own inertia.

WARNING!

Be sure the hood is fully latched before driving your vehicle. If the hood is not fully latched, it could open when the vehicle is in motion and block your vision.

(Continued)

WARNING!

Failure to follow this warning could result in serious injury or death.

CAUTION!

To prevent possible damage, do not slam the hood to close it. Use a firm downward push at the front center of the hood to ensure that both latches engage.

2

TAILGATE

OPENING

The tailgate may be opened by pushing the tailgate button on the key fob, pushing the tailgate button on the overhead console, or by pushing the release pad located on the tailgate door. These methods of opening can also apply to vehicles equipped with either Power Tailgate or the Multi-Function Tailgate.

The tailgate damper strut will lower the tailgate to the open position (if equipped).

WARNING!

It is very dangerous to ride on the tailgate, even when the vehicle is traveling at low speeds. Anyone riding on the tailgate could easily fall in response to the vehicle maneuvers or rough terrain. Passengers should always sit in the vehicle seats and use their seatbelt. Failure to follow this warning could result in serious injury or death.

Electronic Tailgate Release — If Equipped



The key fob may be equipped with an electronic release feature for the tailgate, allowing hands-free tailgate opening. To activate, push and release the Tailgate

Release button on the key fob twice within five seconds. The tailgate door will unlatch, and slowly lower into the open position.

If equipped, a button on the center overhead console inside the vehicle can be used to release the tailgate. An indicator light may also signal when the tailgate is open.

For the tailgate to lower, the vehicle must be stationary and in PARK or NEUTRAL.

NOTE:

The optional Tri-Fold Tonneau Cover ⇨ page 102 may prevent electronic tailgate release. The Tonneau Cover must be removed or folded up before releasing the tailgate.

WARNING!

To avoid injury, make sure there is no one in the way of the power tailgate as it is opening or closing, and keep hands away from the tailgate hinges when in use. You or others could be injured if caught in the path of the power tailgate or tailgate hinges.

CLOSING

To close the tailgate, push it upward until both sides are securely latched. After closing the tailgate, pull it back to be sure it is latched securely.

If equipped with a Power Tailgate, you may use the key fob, overhead console, or release pad located on the tailgate door to close the tailgate automatically.

NOTE:

When the tailgate is open and the vehicle is in the ON/RUN position and in any gear other than PARK, a message will appear in the instrument cluster display.

POWER TAILGATE— IF EQUIPPED

The power tailgate may be opened or closed in several ways:

- Overhead console tailgate button
- Key fob
- Outside handle (open or reset tailgate latch)
- Left side Tailgate Switch (closing only)
- Tip-To-Close

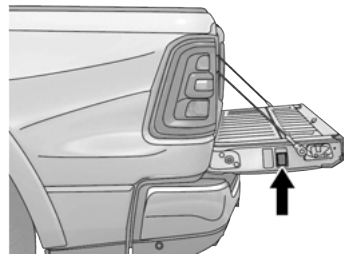

Left Side Tailgate Switch

0239202297US

Using the previously listed ways to open or close the tailgate:

- When the tailgate is fully closed, the tailgate will open
- When the tailgate is fully open, the tailgate will close
- When the tailgate is moving, the tailgate will reverse

To Open/Close Using The Key Fob

- To open: push the tailgate button twice.
- To close: push the tailgate button twice, and hold on the second press.

To Open/Close Using The Overhead Console Switch

- To Open: Push the power tailgate button once.
- To Close: Push the power tailgate button once, a message will appear in the instrument cluster to confirm tailgate area is clear of obstacles. Press the button a second time to close the tailgate.

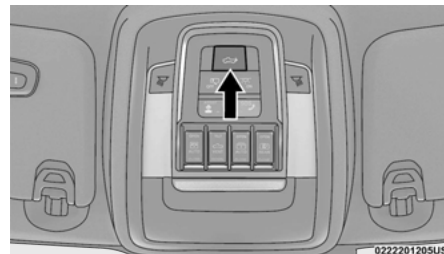

Overhead Console Power Tailgate Switch

0222201205US

Tip To Close

To close the tailgate manually, gently start lifting the tailgate, it will continue to close until it latches.

Obstacle Detection

There are pinch sensors attached to the side of the tailgate. Light pressure anywhere along these strips will cause the tailgate to stop.

NOTE:

If the power tailgate will not fully open or latch close, check the latch for damage or obstacles that may be preventing the closing operation. If the problem persists, proceed as follows:

1. Press the electronic tailgate release handle on the outside of the tailgate to home/reset the latch mechanism.
2. Manually close the tailgate by pushing it upward until both sides are securely latched. After closing the tailgate, pull it back to be sure it is latched securely.
3. Resume normal power tailgate open or closing operation.

If the home/reset procedure is unsuccessful, see an authorized dealer for service.

MULTIFUNCTION TAILGATE — If Equipped

The 60/40 multifunction tailgate has two swing doors to allow for closer access to the pickup box with the doors open.

Opening

The tailgate must be latched closed to open the swing doors. Push the paddle down, then pull the release

handle beneath the tailgate lowering handle. This opens the 60 split door.

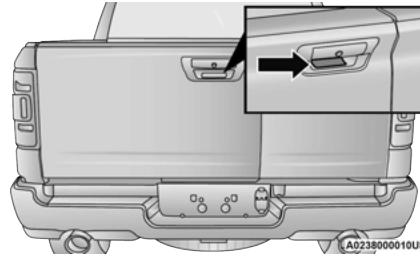
**60 Split Door Release Handle**

Once the 60 split swing door is opened, pull the release handle on the inboard side of the 40 split door to open.

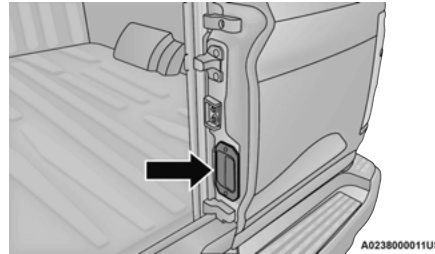
**40 Split Door Release Handle****Closing**

Always close the 40 split door first, then close the 60 split door. The swing doors must be securely latched before the tailgate can be lowered.

NOTE:

- When the swing doors are open, the maximum load placed on a door cannot exceed 180 lb (82 kg).
- Pull back on the swing doors firmly after closing to ensure they are securely latched. Similar to the side door ajar light inside the cab, the bed light above the rear window will remain on if the tailgate doors are not fully closed.

WARNING!

To prevent serious injury or death:

- Make sure there is no one in the way of the swing doors or tailgate that is being opened or closed, and keep away from their hinges when in use. You or others could be injured if caught in the path of the swing doors, tailgate, or their hinges.
- Never operate the vehicle with the swing doors open.
- Never hang from or sit on the swing doors.

CAUTION!

- Always check both swing doors are latched before starting vehicle.
- Vehicle damage may occur if doors are not securely latched.

LOCKING TAILGATE

The tailgate can be locked using the key fob lock button.

TAILGATE REMOVAL

This section covers the removal steps for Manual Tailgate and Multifunction Tailgate, for Power Tailgate Removal, refer to  page 90.

NOTE:

Removing the tailgate will disable the rearview camera function.

To remove the tailgate, refer to the following instructions:

1. Open tailgate 90° to full open position.
2. Closing tailgate to 45° and lift up on the right side of the tailgate, lifting it off of the pivot.

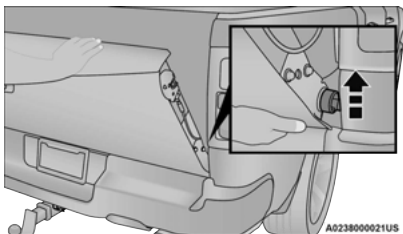

Lift Right Side Off Of Pivot

3. Without latching, rotate the tailgate to nearly closed. Then, while providing support to the tailgate, slide it slowly to the right, removing the tailgate from the left pivot.

NOTE:

Rest the tailgate on the bumper so that the entire tailgate is secure and supported.

WARNING!

For vehicles equipped with a multifunction tailgate, the tailgate weighs 115 lb (52 kg) and should be removed by at least two people. Injury to the customer or damage to the tailgate may occur if one person tries to remove the multifunction tailgate.

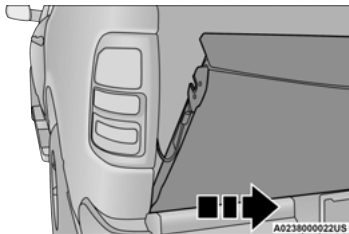

Slide Tailgate To The Right

4. Let the tailgate rest on the support cables while having the tailgate naturally slide forward on the bumper.

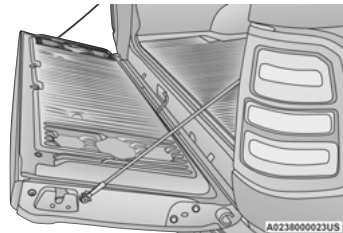

Tailgate Only Supported By Cables

5. Remove the connector bracket from the sill by pushing inward in the locking tab.

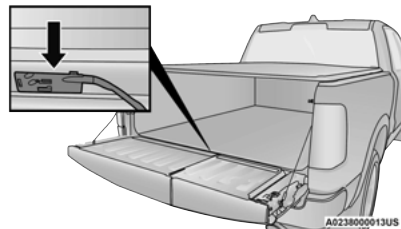

Connector Bracket Location

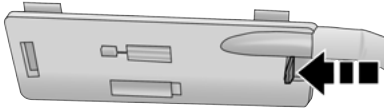

A023800014US

Locking Tab

6. Disconnect the wiring harness by pushing on the two release tabs, ensuring the connector bracket does not fall into the sill.

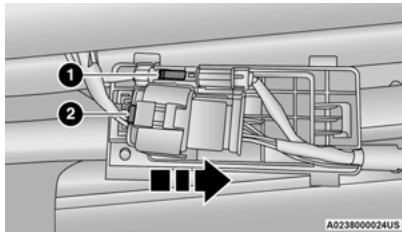

A0238000024US

Connected Wiring Harness

- 1 – First Release Tab
2 – Second Release Tab

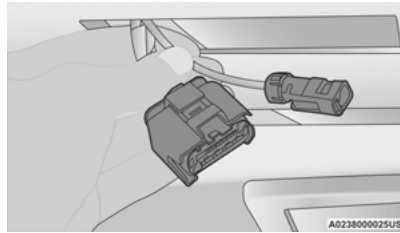

A0238000025US

Disconnected Body Side Harness

7. Connect the body side plug (provided in the glove compartment) to the body side wiring harness and insert the bracket back into the sill.

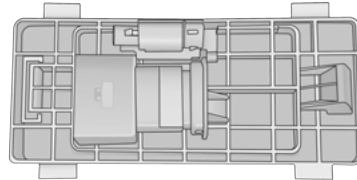

A0238000027US

Body Side Plug (One Piece)

8. Connect the tailgate plugs (provided in the glove compartment) to the tailgate wiring harness to ensure that the terminals do not corrode.

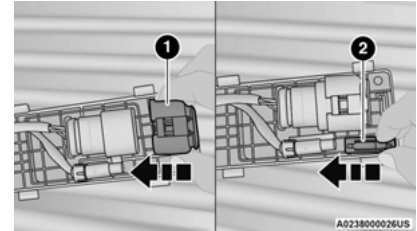

A0238000026US

Tailgate Plugs (Two Pieces)

- 1 – Large Plug
2 – Small Plug

9. Tape the tailgate harness and bracket against the forward-facing surface of the tailgate. This will prevent damaging the connector and bracket when storing or reinstalling the tailgate.

10. Raise the tailgate slightly, and remove the support cables by releasing the lock tang from the pivot.

NOTE:

Make sure tailgate is supported by you and/or a second person when removing support cables.

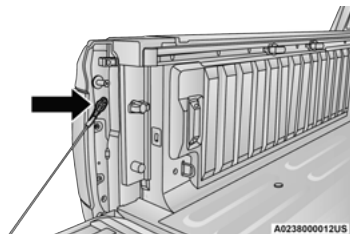
**Locking Tang**

11. Remove the tailgate from the vehicle.

NOTE:

- Do not carry the tailgate loose in the truck pickup box.
- If the tailgate is closed with the wire harness disconnected, the tailgate can only be opened by removing the inside panel and unlatching the locking mechanism manually.

WARNING!

To avoid inhaling carbon monoxide, which is deadly, the exhaust system on vehicles equipped with "Cap or Slide-In Campers" should extend beyond the overhanging camper compartment and be free of leaks.

INSTALLING THE TAILGATE

This section covers the install steps for Manual Tailgate and Multifunction Tailgate, for Power Tailgate Install, refer to ⇨ page 93.

To install the tailgate, refer to the following instructions:

1. Raise the tailgate slightly, and install the support cables by reattaching the lock tang to the pivot

NOTE:

Make sure tailgate is supported by you and/or a second person when installing support cables.

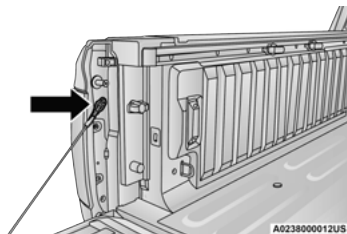
**Locking Tang**

2. Tape the tailgate harness and bracket against the forward-facing surface of the tailgate. This will prevent damaging the connector and bracket when reinstalling the tailgate.
3. Remove the tailgate plugs (store in the glove compartment when not using) from the tailgate wiring harness.

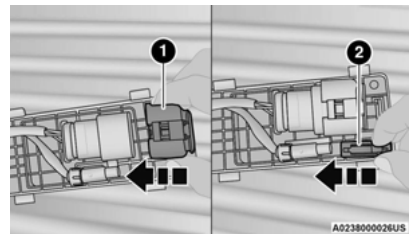
**Tailgate Plugs (Two Pieces)**

1 – Large Plug

2 – Small Plug

4. Remove the body side plug (store in the glove compartment when not using) from the body side wiring harness.

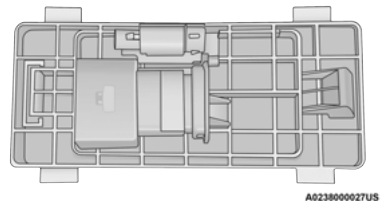
**Body Side Plug (One Piece)**

5. Connect the wiring harness to the connector bracket.

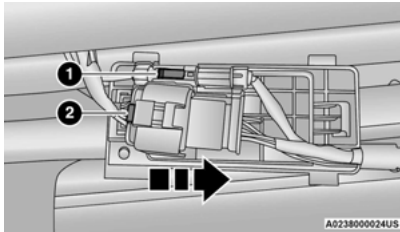

Connected Wiring Harness

- 1 — First Release Tab
2 — Second Release Tab

6. Install the connector bracket to the sill by pulling the locking tab outwards.

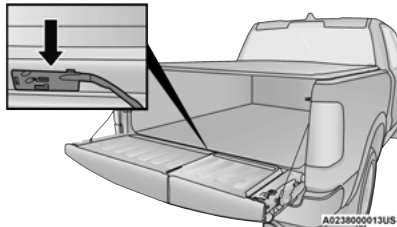

Connector Bracket Location

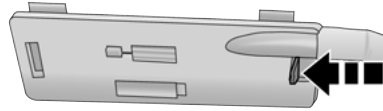

A0238000014US

Locking Tab

7. Let the tailgate rest on the support cables while having the tailgate naturally slide forward on the bumper.

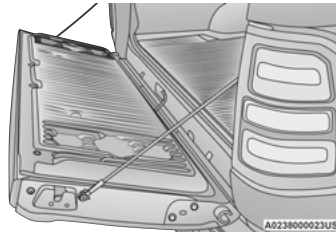

A0238000023US

Tailgate Only Supported By Cables

8. After latching, rotate the tailgate to nearly closed. Then, while providing support to the tailgate, slide it slowly to the left, installing the tailgate to the left pivot.

NOTE:

Rest the tailgate on the bumper so that the entire tailgate is secure and supported.

WARNING!

For vehicles equipped with a multifunction tailgate, the tailgate weighs 115 lb (52 kg) and should be removed by at least two people. Injury to the customer or damage to the tailgate may occur if one person tries to remove the multifunction tailgate.

2

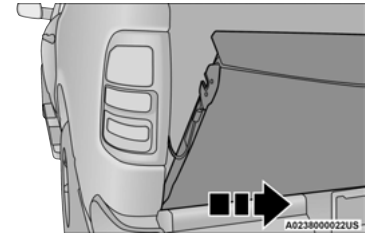

A0238000022US

Slide Tailgate To The Left

9. Closing tailgate to 45° and lift up on the right side of the tailgate, lifting it onto the pivot.

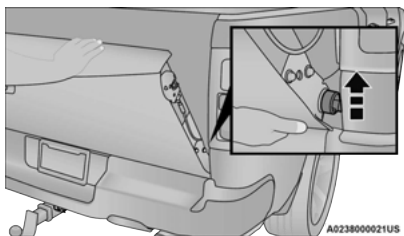

Lift Right Side Onto Pivot

WARNING!

To avoid inhaling carbon monoxide, which is deadly, the exhaust system on vehicles equipped with “Cap or Slide-In Campers” should extend beyond the overhanging camper compartment and be free of leaks.

POWER TAILGATE REMOVAL

NOTE:

- Power tailgate must be opened before starting procedure.
- The power tailgate is equipped with a tip-to-close feature. It is important to disconnect the power before attempting to remove the tailgate.
- Removing the tailgate will disable the rearview camera function.

WARNING!

For vehicles equipped with a power tailgate, the tailgate weighs 48 lb (21 kg) and should be removed by at least two people. Injury to the customer or damage to the tailgate may occur if one person tries to remove the power tailgate.

To remove the tailgate, refer to the following instructions:

1. Locate the wiring harness underneath the vehicle.

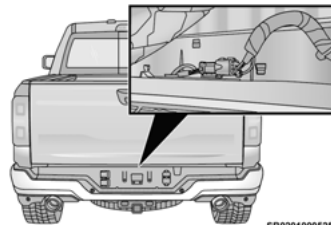

SB0201000525

Wiring Harness Location

2. Between the tailgate and the bumper, remove the connector bracket from the sill by pushing inward in the locking tab.

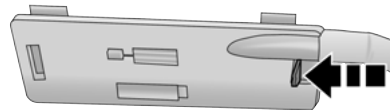

A0238000014US

Locking Tab

3. Disconnect the wiring harness by pushing down on the two release tabs, ensuring the connector bracket does not fall into the sill.

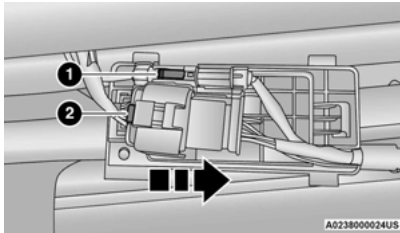

Connected Wiring Harness

- 1 – First Release Tab
2 – Second Release Tab

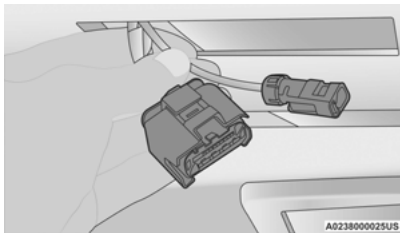

Disconnected Body Side Harness

4. Open tailgate 90° to full open position.
5. Remove the locking bolt located on the right side hinge using a 10 mm hex socket/ wrench.

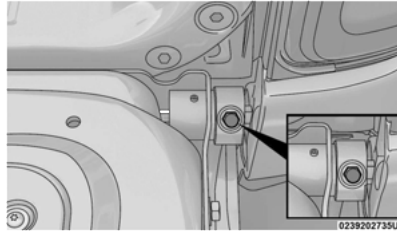

Locking Bolt

NOTE:

When reinstalling the tailgate on the box, a new bolt will be needed or Mopar® certified thread-locking fluid will have to be added to the bolt threads to secure the joint. This bolt needs to be secured using 28Nm (+/- 2Nm).

6. Close the tailgate to 45° and lift up on the right side of the tailgate, lifting it off of the pivot.

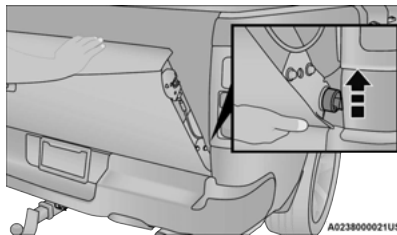

Lift Right Side Off Of Pivot

7. Without latching, rotate the tailgate to nearly closed. Then, while providing support to the tailgate, slide it slowly to the right, removing the tailgate from the left pivot.

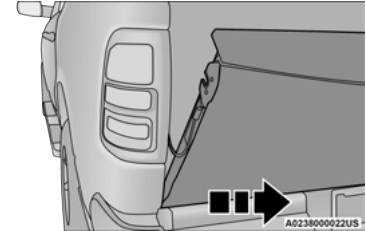

Slide Tailgate To The Right

NOTE:

Rest the tailgate on the bumper so that the entire tailgate is secure and supported.

8. Let the tailgate rest on the support cables while having the tailgate naturally slide forward on the bumper.

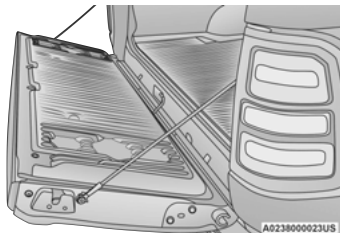

Tailgate Only Supported By Cables

9. Tape the tailgate harness and bracket against the forward-facing surface of the tailgate. This will prevent damaging the connector and bracket when storing or reinstalling the tailgate.
10. Raise the tailgate slightly, and remove the support cables by releasing the lock tang from the pivot.

NOTE:

Make sure tailgate is supported by you and/or a second person when removing support cables.

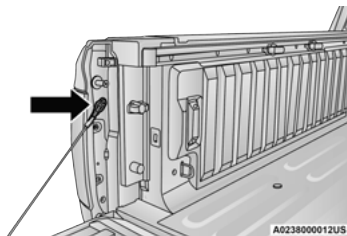

Locking Tang

11. Remove the tailgate from the vehicle.
12. Connect the body side plug (provided in the glove compartment) to the body side wiring harness and insert the bracket back into the sill.

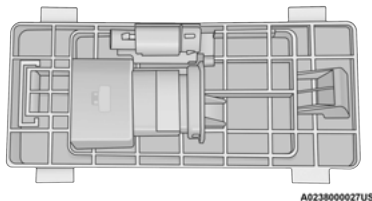

Body Side Plug (One Piece)

13. Connect the tailgate plugs (provided in the glove compartment) to the tailgate wiring harness to ensure that the terminals do not corrode.

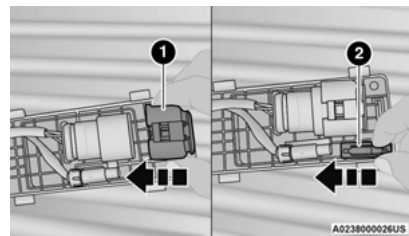

Tailgate Plugs (Two Pieces)

- 1 – Large Plug
2 – Small Plug

NOTE:

- Do not carry the tailgate loose in the truck pickup box.
- If the tailgate is closed with the wire harness disconnected, the tailgate can only be opened by removing the inside panel and unlatching the locking mechanism manually.

WARNING!

To avoid inhaling carbon monoxide, which is deadly, the exhaust system on vehicles equipped with "Cap or Slide-In Campers" should extend beyond the overhanging camper compartment and be free of leaks.

INSTALLING THE POWER TAILGATE

To install the tailgate, refer to the following instructions:

1. Raise the tailgate slightly, and install the support cables by reattaching the lock tang to the pivot

NOTE:

Make sure tailgate is supported by you and/or a second person when installing support cables.

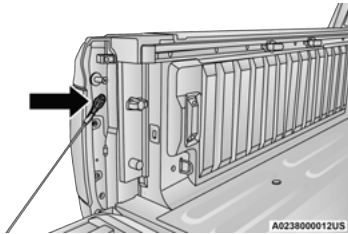

Locking Tang

2. Tape the tailgate harness and bracket against the forward-facing surface of the tailgate. This will prevent damaging the connector and bracket when reinstalling the tailgate.
3. Let the tailgate rest on the support cables while having the tailgate naturally slide forward on the bumper.

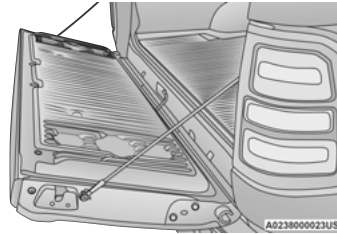

Tailgate Only Supported By Cables

4. Remove the tailgate plugs (store in the glove compartment when not using) from the tailgate wiring harness.

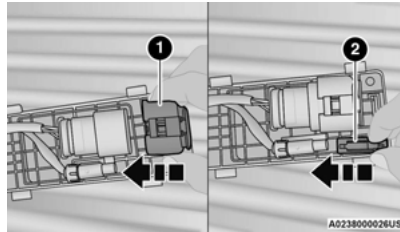

Tailgate Plugs (Two Pieces)

- 1 — Large Plug
- 2 — Small Plug

5. Push the wiring harness through the bodyside wiring access hole.

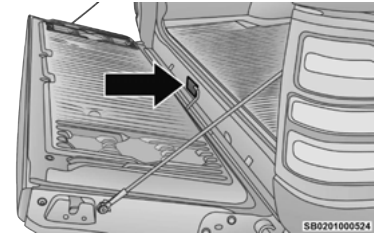

Wiring Access Hole

6. Install the connector bracket to the sill by pulling the locking tab outwards.

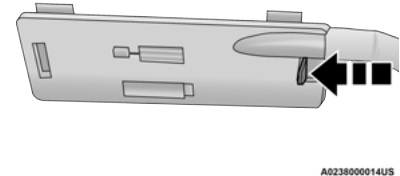

Locking Tab

7. Remove the body side plug (store in the glove compartment when not using) from the body side wiring harness.

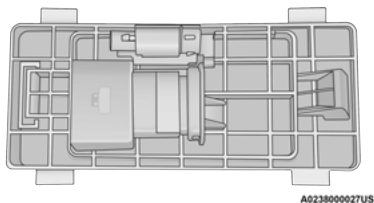

Body Side Plug (One Piece)

8. After latching, rotate the tailgate to nearly closed. Then, while providing support to the tailgate, slide it slowly to the left, installing the tailgate to the left pivot.

NOTE:

Rest the tailgate on the bumper so that the entire tailgate is secure and supported.

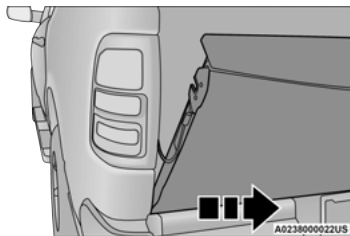

Slide Tailgate To The Left

9. Closing tailgate to 45° and lift up on the right side of the tailgate, lifting it onto the pivot.

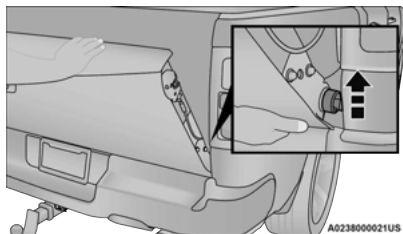

Lift Right Side Onto Pivot

10. Install locking bolt located on the right side hinge using a 10 mm hex socket/ wrench.

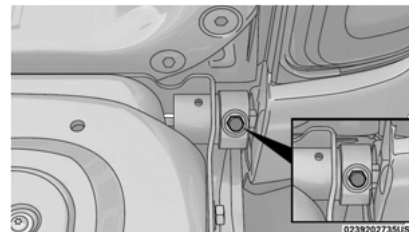

Locking Bolt

NOTE:

When reinstalling the tailgate on the box, a new bolt will be needed or Mopar® certified thread-locking fluid will have to be added to the bolt threads to secure the joint. Tighten bolt securely to 28Nm (+/- 2Nm).

11. Connect the wiring harness to the connector bracket.

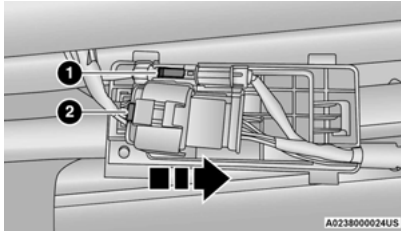

Connected Wiring Harness

- 1 — First Release Tab
2 — Second Release Tab

WARNING!

To avoid inhaling carbon monoxide, which is deadly, the exhaust system on vehicles equipped with "Cap or Slide-In Campers" should extend beyond the overhanging camper compartment and be free of leaks.

BED STEP — IF EQUIPPED

Your vehicle may be equipped with an extendable bed step to provide easier entry and exit into the truck bed.

If your vehicle is equipped with a standard tailgate, the step will be located on the driver's side of the tailgate. If equipped with a multifunction tailgate, the step will be located below the center of the tailgate.

Bed Step For Standard Tailgate

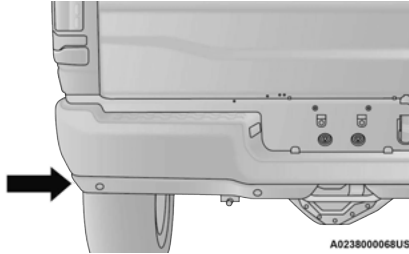

Bed Step Location

To extend the bed step, place your foot on the protruding foot tab located on the left edge of the bed step, and push rearward. A small amount of force will release the spring load and extend the bed step out and away from the tailgate.

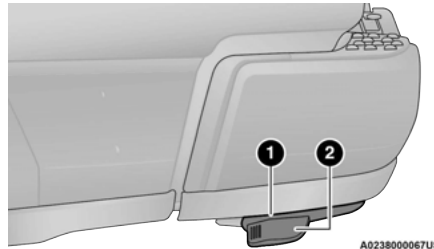

Bed Step Components (Standard Tailgate)

- 1 — Bed Step
2 — Foot Tab

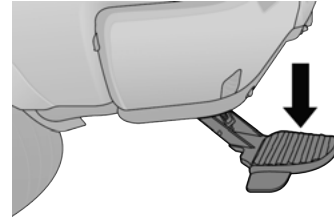

Bed Step Extended

A0238000069US

NOTE:

Once the spring load is overcome, the bed step will extend out quickly, so be sure to stand in a position that will avoid coming into contact with the step as it extends.

To stow the bed step back under the tailgate, push the bed step forward with your foot until the bed step is retracted by the spring load.

WARNING!

Do not attempt to stow the bed step with your hands. The low clearance space between the bed step and the rear bumper as the bed step returns to the stowed position could result in injury to your hands or fingers.

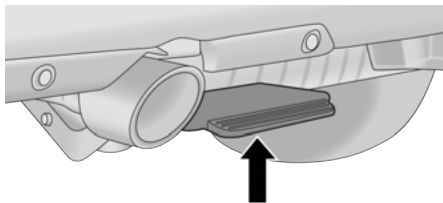
Bed Step For Multifunction Tailgate

A0238000133US

Bed Step Location

To extend the bed step, place your foot on the top center of the bed step, and push down while pulling rearward. A small amount of force will release the spring load and extend the bed step out and away from the tailgate.

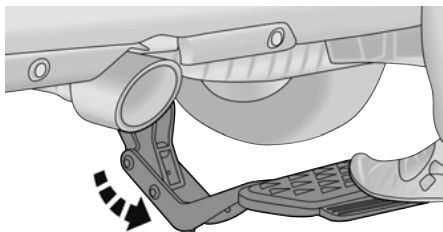

A0238000134US

Bed Step Extended**NOTE:**

Once the spring load is overcome, the bed step will extend out quickly. Be sure to stand in a position that will avoid coming into contact with the step as it extends.

To stow the bed step back under the tailgate, push the bed step forward with your foot until the bed step is retracted by the spring load.

WARNING!

Do not attempt to stow the bed step with your hands. The low clearance space between the bed step and the rear bumper as the bed step returns to the stowed position could result in injury to your hands or fingers.

PICKUP BOX

The pickup box has many features designed for utility and convenience.

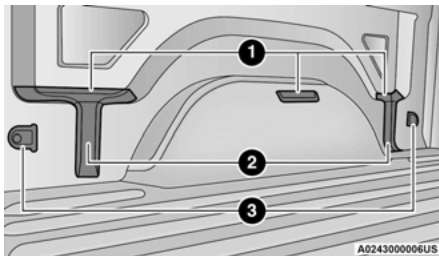

A0243000006US

Pickup Box Features

- 1 — Upper Load Floor Indents
- 2 — Bulk Head Dividers
- 3 — Cleats

NOTE:

If you are installing a toolbox, ladder rack or headache rack at the front of the pickup box, you must use Mopar® Box Reinforcement Brackets that are available from an authorized dealer.

You can carry wide building materials (sheets of plywood, etc.) by building a raised load floor. Place lumber across the box in the indentations provided above the wheel housings and in the bulkhead dividers to form the floor.

WARNING!

- The pickup box is intended for load carrying purposes only, not for passengers, who should sit in seats and use seat belts.
- Care should always be exercised when operating a vehicle with unrestrained cargo. Vehicle speeds may need to be reduced. Severe turns or rough roads may cause shifting or bouncing of the cargo that may result in vehicle damage. If wide building materials are to be frequently carried, the installation of a support is recommended. This will restrain the cargo and transfer the load to the pickup box floor.
- If you wish to carry more than 600 lb (272 kg) of material suspended above the wheelhouse, supports must be installed to transfer the weight of the load to the pickup box floor or vehicle

(Continued)

WARNING!

damage may result. The use of proper supports will permit loading up to the rated payload.

- Unrestrained cargo may be thrown forward in an accident causing serious or fatal injury.

There are stampings in the sheet metal on the inner side bulkheads of the box in front of and behind both wheel housings. Place wooden boards across the box from side to side to create separate load compartments in the pickup box.

There are four tie-down cleats bolted to the lower sides of the pickup box that can sustain loads up to 1,000 lb (450 kg) total.

BED RAIL TIE-DOWN SYSTEM — IF EQUIPPED**CAUTION!**

The maximum load per cleat should not exceed 250 lb (113 kg), or 500 lb (227 kg) total per rail, and the angle of the load on each cleat should not exceed 45 degrees above horizontal, or damage to the cleat or cleat rail may occur.

There are two adjustable cleats on each side of the bed that can be used to assist in securing cargo.

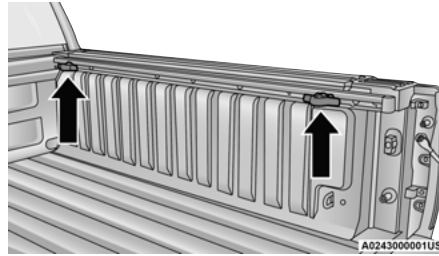
**Adjustable Cleats**

Each cleat must be located and tightened down in one of the detents, along either rail, in order to keep cargo properly secure.

To move the cleat to any position on the rail, turn the nut counterclockwise, approximately three turns. Then pull out on the cleat and slide it to the detent nearest the desired location. Make sure the cleat is seated in the detent and tighten the nut.

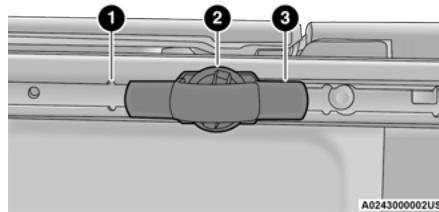
**Adjustable Cleat Assembly**

- 1 — Utility Rail Detent
- 2 — Cleat Retainer Nut
- 3 — Utility Rail Cleat

Cleat Removal (Standard Box Rail)

To remove the cleats from the utility rail, slide the cleat forward to access the cut out at the end of the box rail, then remove the cleat.

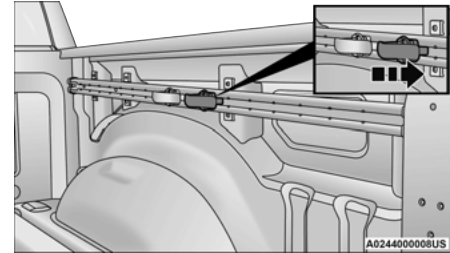
**Slide Cleat Forward To Remove****Cleat Removal (With Tonneau Cover)**

To remove the cleats from the utility rail, remove the end cap screw located in the center of the end cap, using a #T30 Torx head driver. Remove the end cap and slide the cleat off the end of the rail.

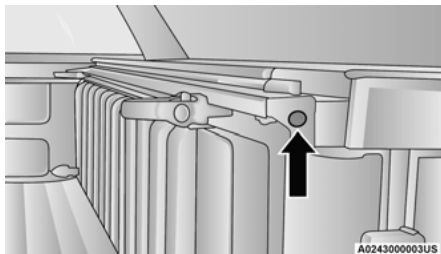

End Cap Screw Location With Tonneau Cover

Cleat Removal (Without Tonneau Cover)

Remove the end cap by pushing upward on the release button located beneath the end cap while pulling the cap away from the rail. The cleat can now be removed by sliding it off the end of the rail.

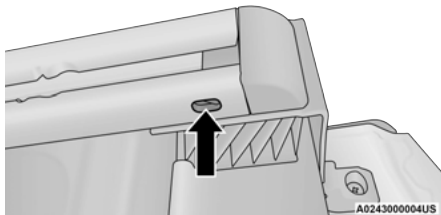

End Cap Release Button Without Tonneau Cover

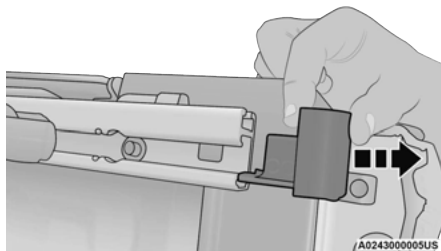

Pull End Cap Away From Rail

RAMBOX — IF EQUIPPED

The RamBox system is an integrated pickup box storage and cargo management system consisting of three features:

- Cargo storage bins
- Cargo divider
- Bed rail tie-down system, if equipped

NOTE:

Bed rail tie-down system is also available for vehicles not equipped with a RamBox.

LOCKING AND UNLOCKING RAMBOX

Push and release the lock or unlock button on the key fob to lock and unlock all doors, the tailgate and the RamBox ⇨ page 19. To unlatch the storage bin manually, insert the emergency key into the keyhole

and turn clockwise. Always return the key to the upright (vertical) position before removing it from the keyhole.

CAUTION!

- Ensure cargo bin lids are closed and latched before moving or driving vehicle.
- Loads applied to the top of the bin lid should be minimized to prevent damage to the lid and latching/hinging mechanisms.
- Damage to the RamBox bin may occur due to heavy/sharp objects placed in bin that shift due to vehicle motion. In order to minimize potential for damage, secure all cargo to prevent movement and protect inside surfaces of bin from heavy/sharp objects with appropriate padding.

RAMBOX CARGO STORAGE BINS

Cargo storage bins are located on both sides of the pickup box. The cargo storage bins provide watertight, lockable, illuminated storage for up to 150 lb (68 kg) of evenly distributed cargo.

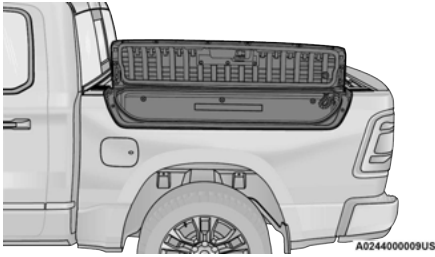

RamBox Cargo Storage Bins

CAUTION!

Failure to follow the following items could cause damage to the vehicle:

- Assure that all cargo inside the storage bins is properly secured.
- Do not exceed cargo weight rating of 150 lb (68 kg) per bin.

To open a storage bin with the RamBox unlocked, push and release the button located on the lid. The RamBox lid will open upward to allow hand access. Lift the lid to fully open.

NOTE:

RamBox will not open when the button is pushed if the RamBox is locked.

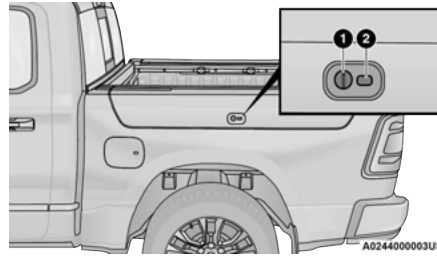

RamBox Button And Keyhole Lock

- 1 – Keyhole Lock
2 – Button

CAUTION!

Leaving the lid open for extended periods of time could cause the vehicle battery to discharge. If the lid is required to stay open for extended periods of time, it is recommended that the bin lights be turned off manually using the on/off switch.

The interior of the RamBox will automatically illuminate when the lid is opened. The timing can be adjusted within Uconnect Settings → page 227.

Cargo bins feature two removable drain plugs (to allow water to drain from bins). To remove a plug, pull up on the edge. To install, push the plug downward into the drain hole.

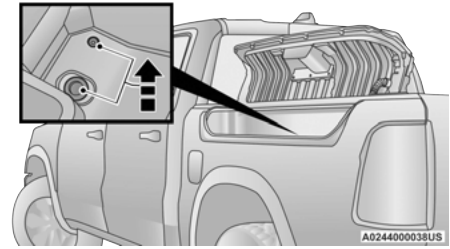

RamBox Drain Plug Removal

NOTE:

Provisions are provided in the bins for cargo dividers. These accessories (in addition to other RamBox accessories) are available from Mopar®.

If equipped, a 115 Volt (400 W maximum) inverter may be located inside the RamBox of your vehicle. The inverter can be turned on by the Instrument Panel Power Inverter switch located to the left of the steering wheel. The RamBox inverter can power cellular phones, electronics and other low power devices requiring power up to 400 W. Certain video game consoles exceed this power limit, as will most power tools.

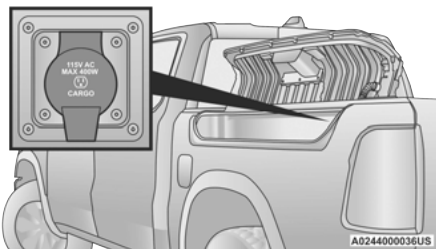

RamBox Power Inverter

The Instrument Panel Power Inverter switch is only found on vehicles equipped with a RamBox. The switch only controls on/off operation of the power outlet in the RamBox; it does not control on/off operation of the power outlets located inside the cabin of the vehicle.

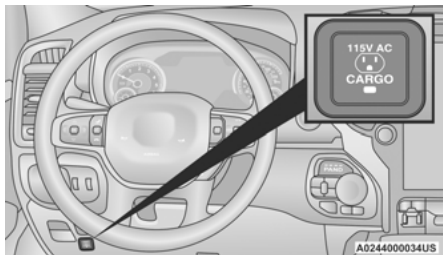

Instrument Panel Power Inverter Switch

RAMBOX SAFETY WARNING

Carefully follow these warnings to help prevent personal injury or damage to your vehicle:

WARNING!

- Always close the storage bin covers when your vehicle is unattended.
- Do not allow children to have access to the storage bins. Once in the storage bin, young children may not be able to escape. If trapped in the storage bin, children can die from suffocation or heat stroke.
- In an accident, serious injury could result if the storage bin covers are not properly latched.
- Do not drive the vehicle with the storage bin covers open.
- Keep the storage bin covers closed and latched while the vehicle is in motion.
- Do not use a storage bin latch as a tie-down.

RamBox Emergency Release Lever

As a security measure, an Emergency Release Lever is built into the storage bin cover latching mechanism.

In the event of an individual being locked inside the storage bin, the storage bin cover can be opened from inside of the bin by pulling on the glow-in-the-dark lever attached to the storage bin cover latching mechanism.

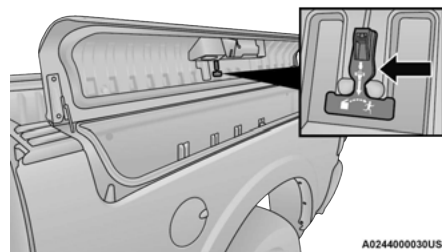

Emergency Release Lever

BED DIVIDER — IF EQUIPPED

The bed divider has two functional positions:

- Storage Position
- Divider Position

Divider Position

The divider position is intended for managing your cargo and assisting in keeping cargo from moving around the bed. There are 11 divider slots along the bed inner panels which allow for various positions to assist in managing your cargo.

To install the bed divider into a divider position, perform the following:

1. Make sure the center handle is unlocked using the vehicle emergency key located within the key fob and rotate the center handle vertically to release the divider side gates.

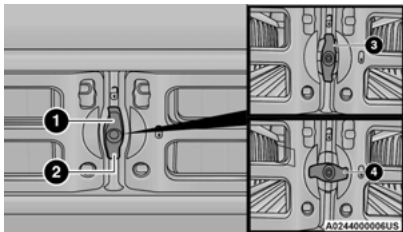

Center Handle And Lock

- 1 — Center Handle Lock
- 2 — Handle
- 3 — Unlocked Position
- 4 — Locked Position

2. With the side gates open, position the divider so the outboard ends align with the intended slots in the sides of the bed.

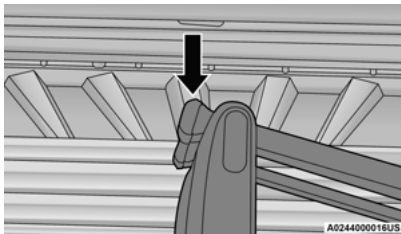

Aligning Gate To Slots

3. Rotate the side gates closed so that the outboard ends are secured into the intended slots of the bed.
4. Rotate the center handle horizontally to secure the side gates in the closed position.

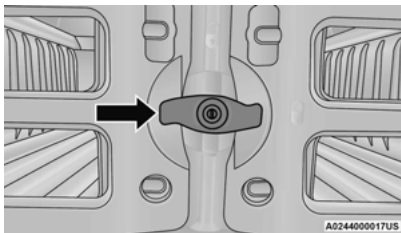

Side Gates Closed

5. Lock the center handle to secure the panel into place.

Storage Position

The storage position for the bed divider is at the front of the truck bed which maximizes the bed cargo area when not in use.

To install the bed divider into the storage position, perform the same steps as you would for the divider position, except position the divider fully forward in the bed against the front panel.

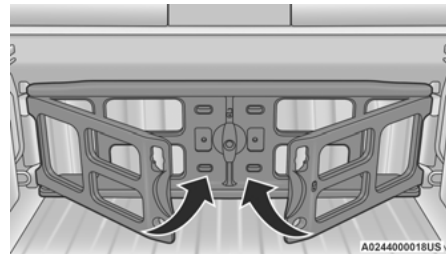

Storage Position

The outboard ends should be positioned in front of the cargo tie-down loops.

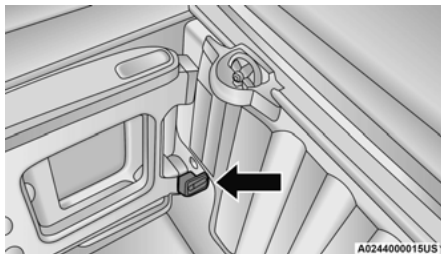

Cargo Tie-Down Loop

TRI-FOLD TONNEAU COVER — IF EQUIPPED

The Tri-Fold Tonneau Cover can be installed on the truck bed to protect your gear and cargo.

TONNEAU COVER COMPONENTS

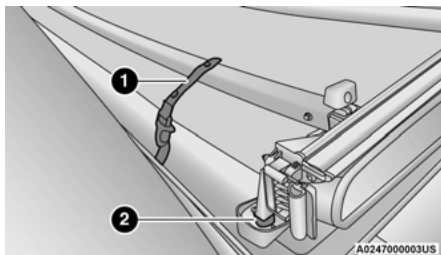

Folded Tonneau Cover Components

- 1 — Stowage Strap
- 2 — Tonneau Cover Bumper Folded

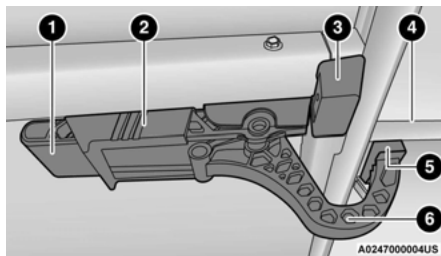

Tonneau Cover Latch Components

- 1 — Handle
- 2 — Slide Locking Lever
- 3 — Locating Bumper
- 4 — Truck Flange Bead
- 5 — Latch Bumper
- 6 — J Hook

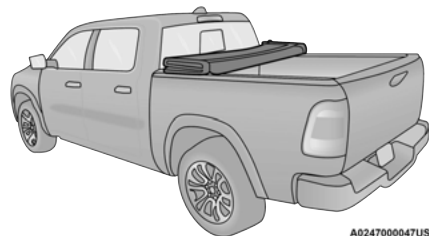

Position One (Front Latches Latched And Stowage Straps Secured)

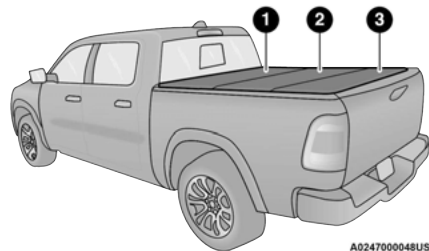

Position Two (Front And Rear Latches Latched)

- 1 — Panel 1
- 2 — Panel 2
- 3 — Panel 3

TRI-FOLD TONNEAU COVER FOLDING FOR DRIVING OR REMOVAL

To remove the Tonneau Cover use the following steps:

1. Open the tailgate to access the rear pair of Tonneau Cover latches located on the underside of the Cover.

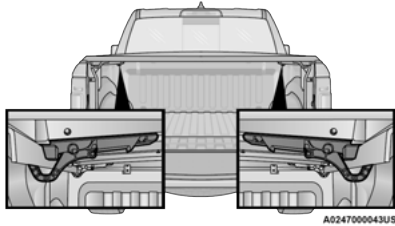

Location Of Rear Latches

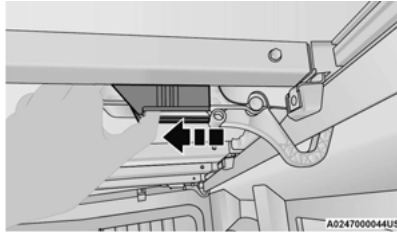

Slide Locking Lever Inward

2. Slide the locking lever toward the inside of the truck bed to release the J Hook and pull the handle downward into the released position.



Unlatching Latch

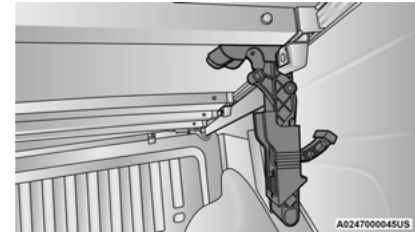

Released Position

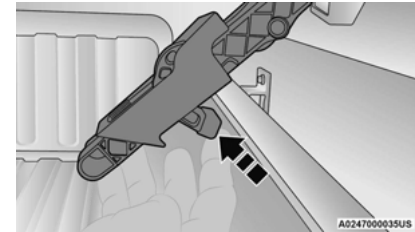

Hold The Bumper And Push The Handle Up

3. Holding the bumper, push the fully released latch to the center and push up. Push the handle firmly, locking it into the stowed position. Repeat Steps 2 and 3 for the opposite side latch.

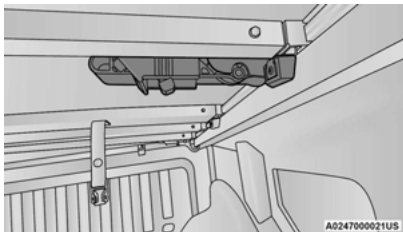

Stowed Position

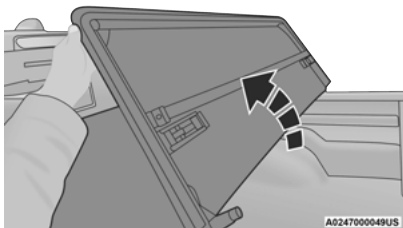

Lift Panel 3 And Fold Onto Panel 2

4. Lift up on Panel 3 and fold it onto Panel 2.



Correct Folding — Hold Panels Together

NOTE:

When folding the second and third panels, the sections **MUST** be held together to avoid damage to the cover material. Fold the panel gently. Do not allow the panels to drop under their own weight.



Incorrect Folding — Will Cause Damage

5. Lift up on the second and third panel and fold them onto the first panel.

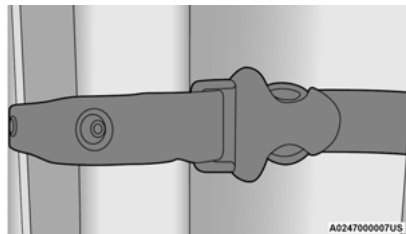

Stowage Strap Clipped

6. Unsnap the stowage strap and clip. Repeat for both straps to prevent the Tonneau Cover panels from unfolding.

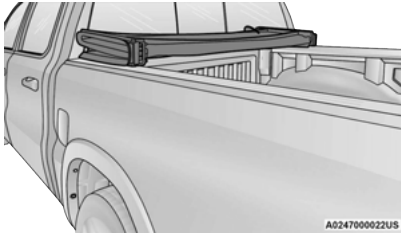

Position One (Front Latches Latched And Stowage Straps Secured)

NOTE:

Be sure the Tonneau Cover has been folded completely, and the stowage straps are engaged, before removing.

CAUTION!

The folded Tonneau Cover must be latched by both front latches and both front stowage straps or damage to the Tonneau Cover or vehicle may occur while driving.

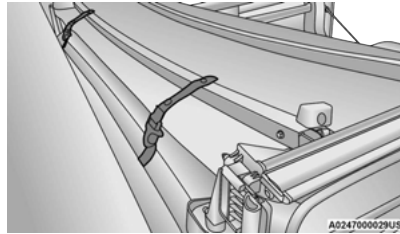

Fully Folded Tonneau Cover

NOTE:

The vehicle can be driven with the Tonneau Cover in the folded position or can be completely removed.

To completely remove the Tonneau Cover, proceed with the following steps:

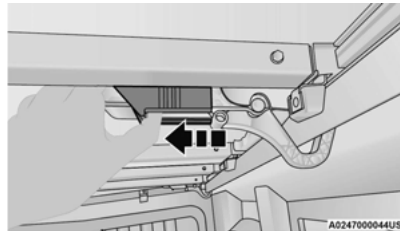

Slide Locking Lever Inward

7. Slide the locking lever toward the inside of the truck bed to release the J Hook and pull the handle downward into the released position.

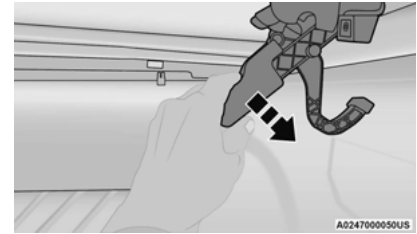

Unlatching Latch

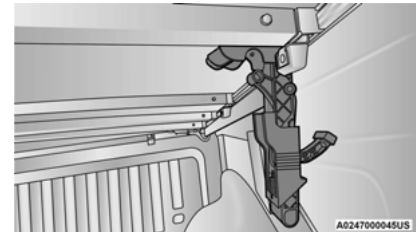

Released Position

8. Holding the bumper, push the fully released latch to the center and push up. Push the handle firmly, locking it into the stowed position. Repeat Steps 2 & 3 for the opposite side latch.



Hold The Bumper And Push The Handle Up

9. With two people, remove the cover.

TRI-FOLD TONNEAU COVER INSTALLATION

To install the Tonneau Cover follow these steps:

1. Position the Tonneau Cover on the truck bed and center using the locating bumpers.
2. Locate the front pair of Tonneau Cover latches on the underside of the Cover. Slide the locking lever toward the inside of the truck bed and release the latch from the stowed position, and pull the handle downward into the released position. Do this for both the left and right side.

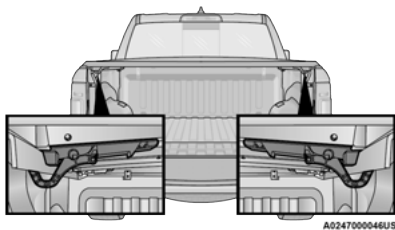

Location of Front Latches

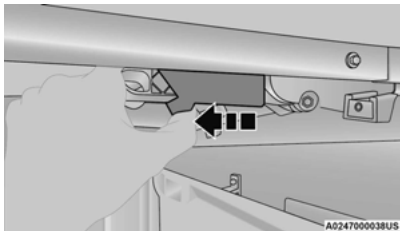

Slide Locking Lever Towards Inside Of Truck



Unlatching Latch

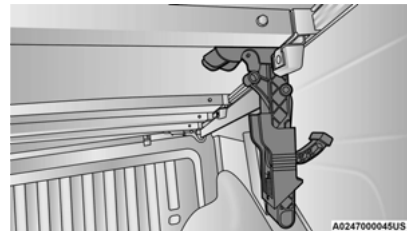

Released Position

- Swing the J Hook from the handle and push the handle to the center and up, ensuring that the J Hook is under the truck flange. Push up on the handle firmly, locking it into the latched position.

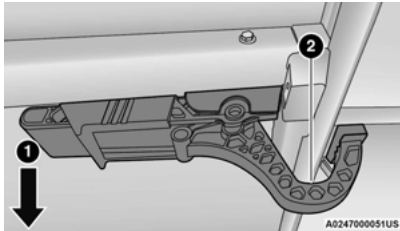

J Hook Under Truck Flange

- 1 — Front Of Truck
2 — J Hook

NOTE:

Make sure the bumper is in front of the truck flange bead.

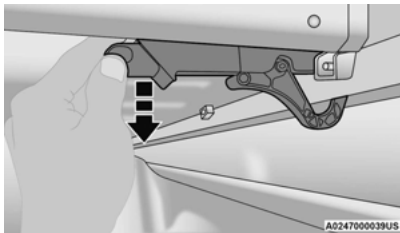

Pull Handle Downward

- Pull down on the handle to ensure the Slide Locking Lever is fully engaged. Do this for both the left and right side.
- Unclip the stowage straps, and re-snap them to the bow.
- Unfold the Tonneau Cover to the second panel position.



Incorrect Folding — Will Cause Damage

NOTE:

When folding the second and third panels, the sections **MUST** be held together to avoid damage to the cover material. Fold the panel gently. Do not allow the panels to drop under their own weight.

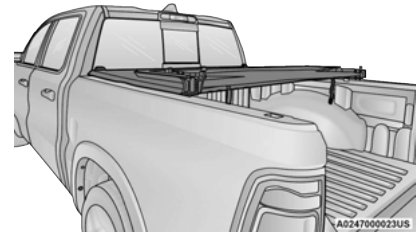

Second Panel Position

NOTE:

Unfold the panel gently, and do not allow the panels to drop under their own weight.

- Completely unfold the Tonneau Cover.

CAUTION!

The vehicle cannot be driven when the Tonneau Cover is in the second panel position.

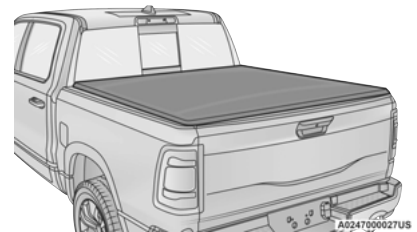

Position Two (Fully Unfolded)

8. Repeat steps 2 through 3 for the rear pair of latches.
9. Pull down on the handle to ensure the Slide Locking Lever is fully engaged. Do this for both the left and right side.

NOTE:

Also check to ensure the latch yellow bumpers are forward of the bead on the underside of the truck flange. Make sure that the Tonneau Cover is positioned fully forward, so that the bumper clears the bead.

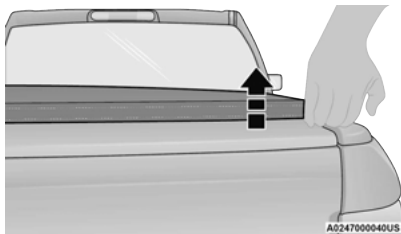
**Pull Up On Tonneau Cover Corners**

10. Gently pull up on all four corners of the Tonneau Cover to ensure that it is properly latched.

WARNING!

You must ensure the Tonneau Cover is properly installed on the vehicle before driving. An unsecured Tonneau Cover can fly off of the vehicle while in motion, resulting in a collision, personal injury, and

(Continued)

WARNING!

death. Failure to follow this procedure can also damage the vehicle and the Tonneau Cover.

CAUTION!

It is the driver's responsibility to ensure the Tonneau Cover is properly installed on the vehicle. Failure to follow this procedure can result in detachment of the Tonneau Cover from the vehicle and/or damage to the vehicle/Tonneau Cover.

TRI-FOLD TONNEAU COVER CLEANING

For proper cleaning of the Tonneau Cover, use Mopar® Whitewall & Vinyl Top Cleaner and Mopar® Leather & Vinyl Conditioner/Protectant.

GETTING TO KNOW YOUR INSTRUMENT PANEL

BASE INSTRUMENT CLUSTER

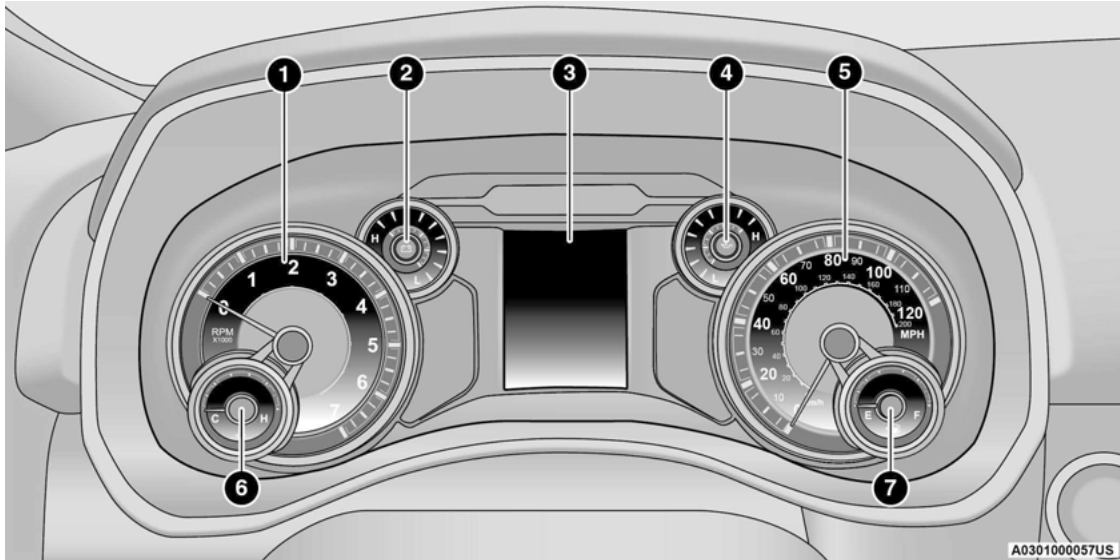

A0301000057US

BASE INSTRUMENT CLUSTER DESCRIPTIONS

1. Tachometer

- Indicates the engine speed in revolutions per minute (RPM x 1000).

2. Voltmeter

- When the vehicle is in the RUN state, the gauge indicates the electrical system voltage. The pointer should stay within the normal range if the battery is charged. If the pointer moves to either extreme left or right and remains there during normal driving, the electrical system should be serviced.

NOTE:

In vehicles equipped with Stop/Start, a reduced voltage may be present during an Autostop.

3. Instrument Cluster Display

- When the appropriate conditions exist, this display shows the instrument cluster display messages  page 116.
- The display always shows one of the main menu items after ignition on.

4. Oil Pressure Gauge

- The pointer should always indicate the oil pressure when the engine is running. A continuous high or low reading under normal driving conditions may indicate a lubrication system malfunction. Immediate service should be obtained from an authorized dealer.

NOTE:

In vehicles equipped with Stop/Start, an oil pressure indication of zero is normal during an Autostop.

5. Speedometer

- Indicates vehicle speed.

6. Temperature Gauge

- The pointer shows engine coolant temperature. The pointer positioned within the normal range indicates that the engine cooling system is operating satisfactorily.
- The pointer will likely indicate a higher temperature when driving in hot weather, up mountain grades, or when towing a trailer. It should not be allowed to exceed the upper limits of the normal operating range.

7. Fuel Gauge

- The pointer shows the level of fuel in the fuel tank when the ignition is in the ON/RUN position.
-  The fuel pump symbol points to the side of the vehicle where the fuel door is located.

WARNING!

A hot engine cooling system is dangerous. You or others could be badly burned by steam or boiling coolant. You may want to call an authorized dealer for service if your vehicle overheats  page 369.

CAUTION!

Driving with a hot engine cooling system could damage your vehicle. If the temperature gauge reads "H," pull over and stop the vehicle. Idle the vehicle with the air conditioner turned off until the pointer drops back into the normal range. If the pointer remains on the "H," turn the engine off immediately and call an authorized dealer for service.

HIGHLINE INSTRUMENT CLUSTER

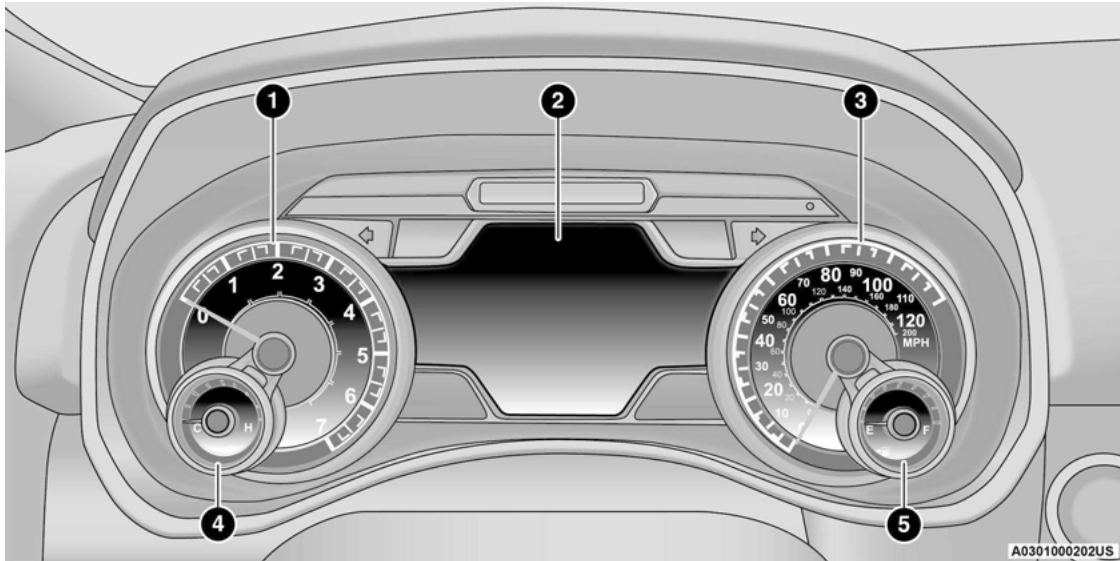

HIGHLINE INSTRUMENT CLUSTER

DESCRIPTIONS

1. Tachometer

- Indicates the engine speed in revolutions per minute (RPM x 1000).

2. Instrument Cluster Display

- When the appropriate conditions exist, this display shows the instrument cluster display messages → page 116.
- The display always shows one of the main menu items after ignition on.

3. Speedometer

- Indicates vehicle speed.

4. Temperature Gauge

- The pointer shows engine coolant temperature. The pointer positioned within the normal range indicates that the engine cooling system is operating satisfactorily.
- The pointer will likely indicate a higher temperature when driving in hot weather, up mountain grades, or when towing a trailer. It should not be allowed to exceed the upper limits of the normal operating range.

WARNING!

A hot engine cooling system is dangerous. You or others could be badly burned by steam or boiling coolant. You may want to call an authorized dealer for service if your vehicle overheats → page 369.

CAUTION!

Driving with a hot engine cooling system could damage your vehicle. If the temperature gauge reads "H," pull over and stop the vehicle. Idle the vehicle with the air conditioner turned off until the pointer drops back into the normal range. If the pointer remains on the "H," turn the engine off immediately and call an authorized dealer for service.

5. Fuel Gauge

- The pointer shows the level of fuel in the fuel tank when the ignition is in the ON/RUN position.



- The fuel pump symbol points to the side of the vehicle where the fuel door is located.

PREMIUM INSTRUMENT CLUSTER

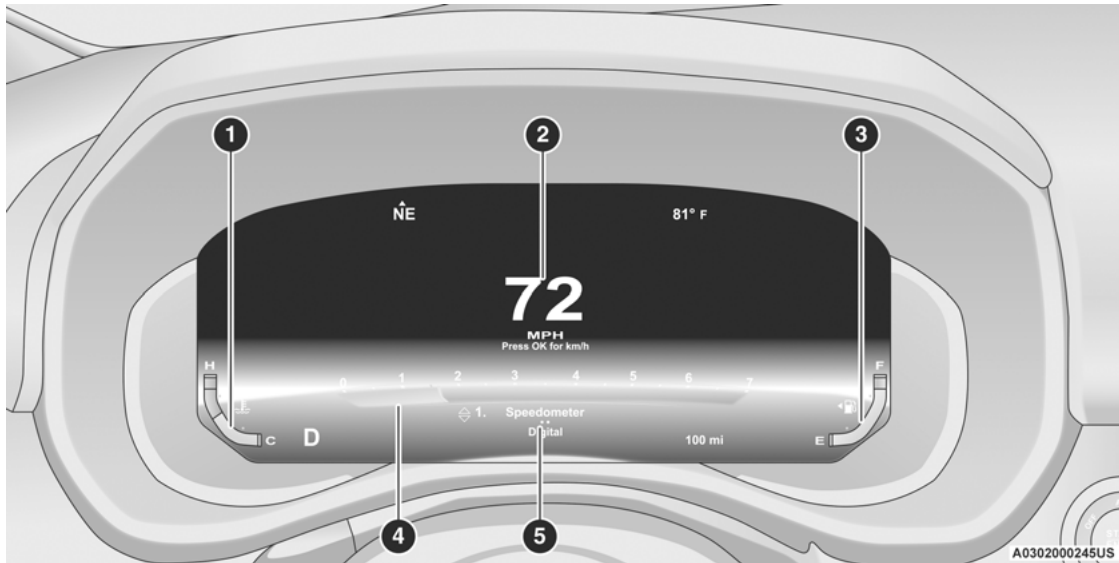

Holding the **OK** button on the Instrument Cluster Display controls located on the steering wheel will allow you to change your display from Digital to Analog.

PREMIUM INSTRUMENT CLUSTER

DESCRIPTIONS

1. Temperature Gauge

- The temperature gauge shows engine coolant temperature. Any reading within 203°F - 230°F (95°C - 110°C) indicates that the engine cooling system is operating satisfactorily.
- The pointer will likely indicate a higher temperature when driving in hot weather, up mountain grades, or when towing a trailer. It should not be allowed to exceed the upper limits of the normal operating range.

WARNING!

A hot engine cooling system is dangerous. You or others could be badly burned by steam or boiling coolant. You may want to call an authorized dealer for service if your vehicle overheats → page 369.

CAUTION!

Driving with a hot engine cooling system could damage your vehicle. If the temperature gauge reads "H," pull over and stop the vehicle. Idle the vehicle with the air conditioner turned off until the pointer drops back into the normal range. If the pointer remains on the "H," turn the engine off immediately and call an authorized dealer for service.

2. Speedometer

- Indicates vehicle speed.

3. Fuel Gauge

- The pointer shows the level of fuel in the fuel tank when the Keyless Push Button Ignition is in the ON/RUN position.



- The fuel pump symbol points to the side of the vehicle where the fuel door is located.

4. Tachometer

- Indicates the engine speed in revolutions per minute (RPM x 1000).

5. Instrument Cluster Display

- The instrument cluster display features a driver interactive display → page 116.

NOTE:

The hard telltales will illuminate for a bulb check when the ignition is first cycled.

PREMIUM INSTRUMENT CLUSTER — RHO



Holding the **OK** button on the Instrument Cluster Display controls located on the steering wheel will allow you to change your display from Analog to Digital.

PREMIUM INSTRUMENT CLUSTER DESCRIPTIONS — RHO

1. Tachometer

- Indicates the engine speed in revolutions per minute (RPM x 1000).

2. Speedometer

- Indicates vehicle speed.

3. Temperature Gauge

- The temperature gauge shows engine coolant temperature. Any reading within 203° F - 230° F

(95 °C - 110 °C) indicates that the engine cooling system is operating satisfactorily.

- The pointer will likely indicate a higher temperature when driving in hot weather, up mountain grades, or when towing a trailer. It should not be allowed to exceed the upper limits of the normal operating range.

WARNING!

A hot engine cooling system is dangerous. You or others could be badly burned by steam or boiling coolant. You may want to call an authorized dealer for service if your vehicle overheats ➞ page 369.

CAUTION!

Driving with a hot engine cooling system could damage your vehicle. If the temperature gauge reads "H," pull over and stop the vehicle. Idle the vehicle with the air conditioner turned off until the pointer drops back into the normal range. If the pointer remains on the "H," turn the engine off immediately and call an authorized dealer for service.

4. Instrument Cluster Display

- The instrument cluster display features a driver interactive display ➞ page 116.

NOTE:

The hard telltales will illuminate for a bulb check when the ignition is first cycled.

5. Fuel Gauge

- The pointer shows the level of fuel in the fuel tank when the Keyless Push Button Ignition is in the ON/RUN position.
-  The fuel pump symbol points to the side of the vehicle where the fuel door is located.

INSTRUMENT CLUSTER DISPLAY

Depending on your vehicle's trim level, features and options may vary.

Your vehicle is equipped with an instrument cluster display, which offers useful information to the driver. With the vehicle in the OFF position, opening/closing of a door will activate the display for viewing, and display the total miles, or kilometers, in the odometer. Your instrument cluster display is designed to display important information about your vehicle's systems and features. Using a driver interactive display located on the instrument panel, your instrument cluster display can show you how systems are working and give you warnings when they are not. The steering wheel mounted controls allow you to scroll through the main menus and submenus. You can access the specific information you want and make selections and adjustments.

INSTRUMENT CLUSTER DISPLAY LOCATION AND CONTROLS

Scan this QR code to learn more about the instrument cluster.

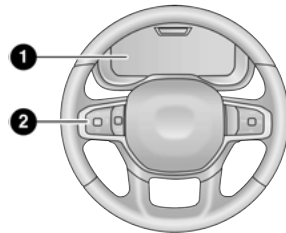

A6302000212U5

Instrument Cluster Display/Controls Location

- 1 — Instrument Cluster Display Screen
- 2 — Instrument Cluster Display Controls

The system allows the driver to select information by pushing the following instrument cluster display control buttons located on the left side of the steering wheel.

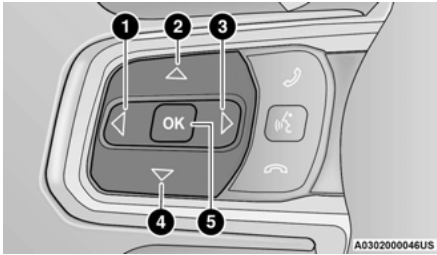

Midline/Highline Instrument Cluster Display Control Buttons

- 1 – Left Arrow Button
- 2 – Up Arrow Button
- 3 – Right Arrow Button
- 4 – Down Arrow Button
- 5 – OK Button

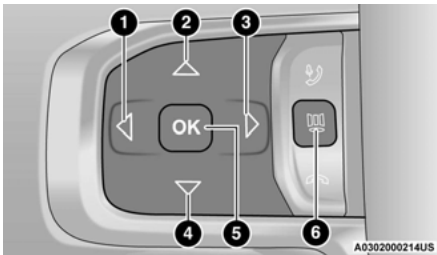

Premium Instrument Cluster Display Control Buttons

- 1 – Left Arrow Button
- 2 – Up Arrow Button
- 3 – Right Arrow Button
- 4 – Down Arrow Button
- 5 – OK Button
- 6 – Home Button

Up Δ And Down ∇ Arrow Buttons:

Using the **up** Δ or **down** ∇ arrow button allows you to cycle through the main menu items.

Left \triangleleft And Right \triangleright Arrow Buttons:

Using the **left** \triangleleft or **right** \triangleright arrow button allows you to cycle through the submenu items of the main menu item.

NOTE:

- Holding the **up** Δ / **down** ∇ or **left** \triangleleft / **right** \triangleright arrow button will loop the user through the currently selected menu or options presented on the screen.
- Main menu and submenus wrap for continuous scrolling.
- Upon returning to a main menu, the last submenu screen viewed within that main menu will be displayed.

OK Button:

For Digital Speedometer:

- Pushing the **OK** button changes units (mph or km/h).

Home Button

- Press Home button for Home Screen display.
- Navigate **left** \triangleleft or **right** \triangleright to highlight desired tile. Press **OK** to select desired. Once **OK** is pressed,

cluster will navigate to selected submenu (e.g. "Audio").

NOTE:

Exiting Home Screen Speed Limit tile and Navigation tile with no Ethernet navigates to Speedometer submenu.

- Press **up** Δ or **down** ∇ to select different screen within selected category.
- If Home button is pressed while in this view, cluster will return to previously displayed screen.
- Press and hold **OK** button to enter edit mode.
 - Instruction text may overlay lower tachometer

For Screen Setup:

- **OK** button allows user to enter menu and submenus.
- Within each submenu layer, the **left** \triangleleft and **Right** \triangleright arrow buttons will allow the user to select the item of interest.
- Pushing the **OK** button makes the selection and a confirmation screen will appear (returning the user to the first page of the submenu).
- Pushing the **up** Δ arrow button will exit each submenu layer and return to the main menu.

Custom Tile Configuration — If Equipped

To customize the instrument cluster further, you are able to select up to five tiles to display information based on your needs.

- Press the **Home** button for the Home Screen display
- Navigate **Left** \triangleleft or **Right** \triangleright to highlight desired tile

- Press **OK** to select the tile and navigate to the selected submenu and press **OK** again to add your selection to your tile view
- If equipped, the main menu options of the home screen are Driver Info, Vehicle Info, Navigation, Audio, and Off Road

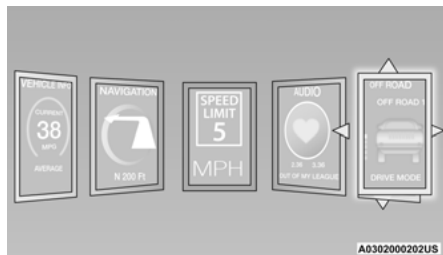

Custom Tile Screen Example

You can customize your Instrument Cluster Display with up to five tiles that may consist of the following:

NOTE:

These options may vary based on your vehicle trim level.

- **Navigation**
 - Route Set / Route Not Set
 - Trip A / Trip B
- **Vehicle Info**
 - Coolant Temp
 - Trans Temp
 - Oil Temp
 - Oil Pressure
 - Battery Voltage
 - Oil Life
 - Tire Pressure
 - Fuel Economy
 - Air Suspension
- **Driver Info**
 - Driver Assist
- **Audio**
 - Audio Info
- **Off Road**
 - Selec-Terrain / Air Suspension Status
 - Steering Angle
 - Pitch
 - Roll
- **Trailer Tow**
 - Trailer Trip
 - Trailer Brake
 - Trailer Tire Pressure Monitor

OIL LIFE RESET

Scan this QR code to learn more about engine oil reset.



Your vehicle is equipped with an engine oil change indicator system. The “Oil Change Required” message will display in the instrument cluster display for five seconds after a single chime has sounded, to indicate the next scheduled oil change interval. The engine oil change indicator system is duty cycle based, which means the engine oil change interval may fluctuate, dependent upon your personal driving style.

Unless reset, this message will continue to display each time you place the ignition in the ON/RUN position. To turn off the message temporarily, push and release the **OK** or arrow buttons. To reset the oil change indicator system (after performing the scheduled maintenance), refer to the following procedure:

1. Without pressing the brake pedal, push the ENGINE START/STOP button and place the ignition in the ON/RUN position (do not start the engine).
2. Push and release the **down** ▾ arrow button to scroll downward through the main menu to “Vehicle Info.”
3. Push and release the **right** ► arrow button to access the “Oil Life” screen.
4. Push and hold the **OK** button to reset oil life. If conditions are met, the gauge and numeric display will update to show 100%. If conditions are not

met a pop-up message of “To reset oil life engine must be off with ignition in run” will be displayed (for five seconds), and the user will remain at the Oil Life screen.

5. Push and release the **up** \triangle or **down** ∇ arrow button to exit the submenu screen.

NOTE:

If the indicator message illuminates when you start the vehicle, the oil change indicator system did not reset. If necessary, repeat this procedure.

DISPLAY MENU ITEMS

Push and release the **up** \triangle or **down** ∇ arrow button until the desired selectable menu icon is highlighted in the instrument cluster display.

Speedometer

Push and release the **up** \triangle or **down** ∇ arrow button until the speedometer menu item is highlighted in the instrument cluster display. Push and release the **OK** button to cycle the display between mph and km/h.

Speedometer options are as follows:

- Analog
- Digital
- Sport View — RHO Only
 - Gear
 - Speedometer
 - G-Force
 - Sport Tachometer

- Baja View — RHO Only

- Oil Pressure
- Speedometer
- Tire Pressure
- Sport Tachometer

Driver Assist/Info

The Driver Assist/Info menu displays the status of the ACC and Active Lane Management systems.

Push and release the **up** \triangle or **down** ∇ arrow button until the Driver Assist/Info menu is displayed in the instrument cluster display.

Adaptive Cruise Control (ACC) Feature

The instrument cluster display displays the current ACC system settings. The information displayed depends on ACC system status.

Push the ACC on/off button (located on the steering wheel) until one of the following displays in the instrument cluster display:

Adaptive Cruise Control Off

When ACC is deactivated, the display will read “Adaptive Cruise Control Off.”

Adaptive Cruise Control Ready

When ACC is activated but the vehicle speed setting has not been selected, the display will read “Adaptive Cruise Control Ready.”

Push the SET + or the SET- button (located on the steering wheel) and the following will display in the instrument cluster display:

ACC SET

When ACC is set, the set speed will display in the instrument cluster.

The ACC screen may display once again if any ACC activity occurs, which may include any of the following:

- Distance Setting Change
- System Cancel
- Driver Override
- System Off
- ACC Proximity Warning
- ACC Unavailable Warning

Active Lane Management — If Equipped

The instrument cluster display displays the current Active Lane Management system settings. The information displayed depends on Active Lane Management system status and the conditions that need to be met \Rightarrow page 197.

Active Driving Assist System — If Equipped

The instrument cluster display displays the current ADAS system settings. When ADAS is engaged a steering wheel icon will appear on the instrument cluster display below the host vehicle \Rightarrow page 187.

Vehicle Info

Push and release the **up** \triangle or **down** ∇ arrow button until the Vehicle Info menu icon is displayed in the

instrument cluster display. Push and release the **left** ◀ or **right** ▶ arrow button to scroll through the information submenus and push and release the **OK** button to select or reset the submenu.

VEHICLE INFO — BASE CLUSTER

- Fuel Economy
 - Average FE
 - Current FE
 - Range to Empty
- Gauge Summary
 - Coolant Temp
 - Trans Temp
 - Oil Temp
 - Oil Pressure
- Coolant Temperature — If Equipped
- Trans Temperature
- Oil Temperature
- Oil Pressure — If Equipped
- Oil Life
- Oil Level — If Equipped
- Battery Voltage — If Equipped
- Tire Pressure Monitor System
- Stop/Start — If Equipped
- Drive Modes — If Equipped

- Air Suspension — If Equipped
- Engine Hours — If Equipped

VEHICLE INFO — PREMIUM CLUSTER

- Fuel Economy
 - Average
 - Current
 - Range to Empty
- Gauge Summary
 - Coolant Temperature — If Equipped
 - Battery Voltage (Hold OK for Storage Mode — RHO Only)
 - Trans Temperature
 - Intake Air Temperature — If Equipped
- Performance Summary — If Equipped
 - Air/Fuel Ratio
 - Engine Power
 - Engine Torque
- Oil Summary
 - Oil Life
 - Oil Temperature
 - Oil Pressure — If Equipped
- Oil Level — If Equipped
- Battery Voltage — If Equipped

- Tire Pressure
- Stop/Start — If Equipped
- Terrain Status — If Equipped
 - Drive Mode — If Equipped
 - Air Suspension Status — If Equipped
- Engine Hours — If Equipped

Fuel Economy — If Equipped

Push and release the **up** ▲ or **down** ▼ arrow button until the Fuel Economy menu item is highlighted in the instrument cluster display. Push and hold the **OK** button to reset Average Fuel Economy.

- Current Fuel Economy
- Average Fuel Economy
- Range To Empty

Stop/Start — If Equipped

Push and release the **up** ▲ or **down** ▼ arrow button until the Stop/Start icon/title is highlighted in the instrument cluster display. The screen will display the Stop/Start status.

Performance Features — If Equipped

Push and release the **up** ▲ or **down** ▼ arrow button until the Performance icon/title is highlighted in the instrument cluster display. Push and release the **left** ◀ or **right** ▶ arrow button to scroll through the performance feature submenus.

WARNING!

Measurement of vehicle statistics with the Performance Features is intended for off-highway or track use only and should not be done on any public roadways. It is recommended that these features be used in a controlled environment and within the limits of the law. The capabilities of the vehicle as measured by the performance pages must never be exploited in a reckless or dangerous manner, which can jeopardize the user's safety or the safety of others. Only a safe, attentive, and skillful driver can prevent accidents.

The Performance Features include the following:

Speed Timers (Best, Last, and Current)	<ul style="list-style-type: none"> ● 0-60 mph (0-100 km/h) ● 0-100 mph (0-160 km/h)
Drag Timers (Best, Last, and Current)	<ul style="list-style-type: none"> ● 0-60 feet (0-20 meters)/Reaction Timer <p>NOTE: Reaction Time result is shown only on the 60 ft timer tab.</p> <ul style="list-style-type: none"> ● 0-330 feet (0-100 meters) ● 1/8 mile (200 meters) ● 0-1000 feet (0-300 meters) ● 1/4 mile (400 meters)

Braking Distance	<ul style="list-style-type: none"> ● Distance ● From Speed
G-Forces	<ul style="list-style-type: none"> ● Current ● Peak
Lap Timer	Shows times for Best, Last, and Current laps ran.
Lap History	Will list the last four laps with the best lap highlighted in green.
Top Speed	Shows the top speed of the vehicle.

Trip Info

Push and release the **up** Δ or **down** ∇ arrow button until the Trip menu item is highlighted in the instrument cluster display. Push and release the **right** \triangleright or **left** \triangleleft arrow button to enter the submenus of Trip A and Trip B. The Trip A or Trip B information will display the following:

- Distance
- Average Fuel Economy
- Elapsed Time

Push and hold **OK** button to reset all information.

Navigation – If Equipped

Push and release the **up** Δ or **down** ∇ arrow button until the Navigation display title is highlighted in the

instrument cluster display, “Hold **OK** to Start Route” will display when no active route is set. “Hold **OK** to Cancel Route” will display when active route is set. Use the **left** \triangleleft or **right** \triangleright arrow button to zoom in or out on the display \Leftrightarrow page 116.

Off Road – If Equipped

Push and release the **up** Δ or **down** ∇ arrow button until the Off Road menu icon is displayed in the instrument cluster display. Push and release the **left** \triangleleft or **right** \triangleright arrow button to scroll through the information submenus.

- Vehicle Dynamics
 - Front Wheel Angle: displays the graphical and numerical value of calculated average front wheel angle from the steering wheel orientation.
 - Transfer Case Lock Status (If Equipped): displays “Lock” graphic only during 4WD High, 4WD Auto, 4WD Low status.
 - Axle Lock Status (If Equipped): displays front and rear or rear only axle locker graphic.
- Pitch And Roll
 - Displays the pitch and roll of the vehicle in the graphic with the angle number on the screen.

NOTE:

When vehicle speed becomes too high to display the pitch and roll, “-” will display in place of the numbers, and the graphic will be grayed out. A message indicating the necessary speed for the feature to become available will also display.

Trailer Tow — If Equipped

Push and release the **up** Δ or **down** ∇ arrow button until the Trailer Tow menu item is highlighted in the instrument cluster display. Push and release the **right** \triangleright or **left** \triangleleft arrow button to cycle through the following trailer tow information:

- **Trip (Trailer Specific) Distance:** Push and hold the **OK** button to reset the distance.
- **Integrated Trailer Brake Module (ITBM):**
 - Braking Output
 - Trailer Type
 - ITBM Gain
- **Trailer Tire Pressure Monitoring:** The Instrument Cluster Display will display the Trailer Tire Pressure for a connected trailer with sensors that match the active trailer profile. When a low tire is present, the low tire value will be displayed in red, and the affected low tire will have a red glow. "Trailer Tire Low" will be displayed on the center bottom of the Instrument Cluster Display screen.

If Equipped, Trailer Light Check and Trailer Setup can be completed through the Uconnect settings \Rightarrow page 279.

Audio

Push and release the **up** Δ or **down** ∇ arrow button until the Audio Menu icon/title is highlighted in the instrument cluster display. This menu will display the audio source information, including the Song name, Artist name, and audio source with an accompanying graphic.

Phone Call Status

When a call is incoming, a Phone Call Status pop-up will display on the screen. The pop-up will remain until the phone is answered or ignored.

NOTE:

The call status will temporarily replace the previous media source information displayed on the screen. When the pop-up is no longer displayed, the display will return to the last used screen.

Messages

Push and release the **up** Δ or **down** ∇ arrow button until the Messages Menu item is highlighted. This feature shows the number of stored warning messages. Push and release the **right** \triangleright or **left** \triangleleft arrow button to cycle through stored messages.

Settings

Head Up Display (HUD) – If Equipped

NOTE:

The HUD feature Settings are available at any vehicle speed.

Screen Setup Driver Selectable Items

Push and release the **left** \triangleleft or **right** \triangleright arrow button until the Settings Menu Icon/Title is highlighted in the instrument cluster display. Push and release the **OK** button to enter the submenus and follow the prompts on the screen as needed. The Settings feature allows you to change what information is displayed in the instrument cluster as well as the location that information is displayed.

NOTE:

Depending on the vehicle's trim level and current status, some options may not be available. The Settings feature is only available when the vehicle speed is less than 5 mph (8 km/h).

Base and Highline Cluster

Upper Left or Right		
None	Time	Current Econ
Compass	Range	Trip A Distance
Outside Temp	Average Econ	Trip B Distance
Trailer Trip – If Equipped	Oil Pressure – If Equipped	Oil Temperature – If Equipped
Trailer Brake – If Equipped	Coolant Temp – If Equipped	Battery Voltage – If Equipped
Transmission Temperature – If Equipped	Oil Life – If Equipped	

Favorite Menus		
Speedometer	Vehicle Info	Performance
Off Road	Driver Assist (show/hide) – If Equipped	Fuel Economy (show/hide)

Favorite Menus		
Trip Info (show/ hide)	Trailer Tow – If Equipped (show/hide)	Audio (show/ hide)
Messages (Stor- ed)	Settings	Diagnostics – If Equipped

Left Side and Right Side – If Equipped		
None	Range To Empty	Average Econ
Oil Temp	Transmission Temp	Coolant Temp
Oil Life	Menu Icon	Trailer Brake

Lower Left and Lower Right – If Equipped		
None	Time	Current Econ
Compass	Range To Empty	Trip A Distance
Outside Temp	Average Econ	Trip B Distance
Trailer Trip – If Equipped	Trailer Brake – If Equipped	Oil Pressure
Coolant Temper- ature	Oil Temperature	Battery Voltage

Lower Left and Lower Right – If Equipped		
Transmission Temperature	Oil Life	

Current Gear

- Off
- On

Odometer

- No Decimal Point
- Decimal Point

Defaults (Restores All Settings To Default Settings)

- Cancel
- Restore

Premium Cluster**Display Style**

- Modern
- Traditional

Upper Left or Right		
None	Time	Current Econ
Compass	Range	Trip A Distance
Outside Temp	Average Econ	Trip B Distance

Upper Left or Right		
Trailer Trip – If Equipped		

Upper Center		
None	Badge	Compass
Outside Temp	Time	Range To Empty
Average Econ	Current Econ	Trip A Distance
Trip B Distance	Trailer Trip	Audio (show/ hide)

Current Gear

- Off
- On

Odometer

- No Decimal Point
- Decimal Point
- Hide

Fuel Gauge

- Hide Range
- Show Range

Favorite Menus		
Performance	Trip Info (show/hide)	Navigation
Off Road	Trailer Tow – If Equipped (show/hide)	Audio (show/hide)

Defaults (Restores All Settings To Default Settings)

- Restore
- Cancel

Speed Warning

Push and release the **up** Δ or **down** ∇ arrow button until the Speed Warning Menu icon/title is displayed in the instrument cluster display. Push and release **OK** to enter speed warning. Use the **up** Δ or **down** ∇ arrow button to select a desired speed, then push and release **OK** to set the speed. The white passive speed limiter telltale will light up with a notification text message (Speed Warning Set to XX, followed by the selected unit). When the set speed is exceeded, an audible chime will sound until the speed is no longer exceeded. The white passive speed limiter telltale will turn yellow and will flash, and a pop-up message of “Speed Warning Exceeded” will display.

NOTE:

You can turn the Speed Warning off by using the **up** Δ / **down** ∇ arrow button to scroll through speed list and select **OFF** at the bottom of the list.

Diagnostics – If Equipped

Push and release the **up** Δ or **down** ∇ arrow button until the Diagnostics icon/title is highlighted in the instrument cluster display. Push and release the **OK** button to display the diagnostic trouble codes and descriptions. When the end of the list is reached, “No or End of Diagnostic Code” will appear in the instrument cluster display.

HEAD UP DISPLAY (HUD) — IF EQUIPPED

NOTE:

The HUD feature Settings are available at any vehicle speed. Some information like speed limit or Driver Assist may not appear on the HUD unless your vehicle is equipped Traffic Sign Assist or Driver Assist systems.

Scan this QR code to learn more about HUD.



- Content and Layout

When “Display On” is selected, the HUD will display on the windshield. When it is not selected, nothing displays on the windshield.

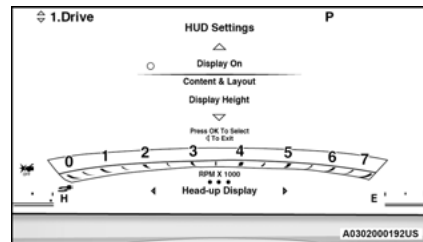

HUD ON/OFF

- Content and Layout
- **Simple:** Speed, Speed Limit
- **Standard:** Speed, Speed Limit, Navigation

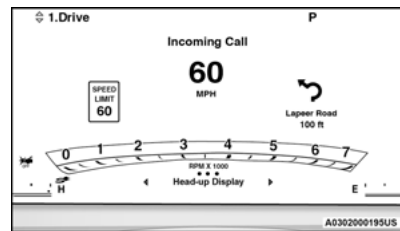

Standard Mode

When “Standard” mode is selected, the HUD image is split into thirds with the speed limit indicator shown to the left, vehicle speed in the center, and turn-by-turn navigation to the right.

- **Advanced:** Speed, Speed Limit, Navigation, Driver Assist (ACC/Cruise, Adaptive Driving Assist, Active Lane Management), Gear



Advanced Mode

When “Advanced” mode is selected, the HUD displays the vehicle speed, turn-by-turn navigation, speed limit, driver assist function(s), and current gear.

- **Custom 1:** Speed, Speed Limit
- **Custom 2:** Speed, Speed Limit, Navigation
- **Custom 3:** Speed, Speed Limit, Navigation, Driver Assist (ACC/Cruise, Adaptive Driving Assist, Active Lane Management)
- **Custom 4:** Speed, Speed Limit, Navigation, Driver Assist (ACC/Cruise, Adaptive Driving Assist, Active Lane Management), Gear
- Display Height
- Brightness

NOTE:

- The HUD basic settings (Brightness, Display Height and Non Custom layouts), are controlled through the Settings Screen in the Instrument Cluster → page 116.
- HUD custom content layout preferences can be selected through your touchscreen. For more information, please refer to your Uconnect Owner’s Manual Supplement.

RHO DRIVE MODE

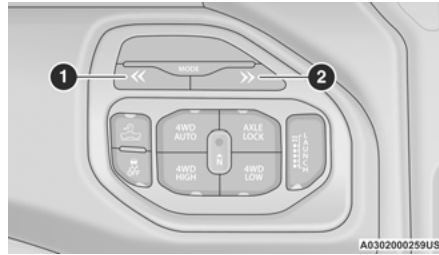

Drive Mode Buttons

- 1 – Left Drive Mode Arrow
- 2 – Right Drive Mode Arrow

Push and release the **left** ◀ or **right** ▶ drive mode arrow button to change between the different Drive Modes. A pop-up will appear in the instrument cluster display to assist with choosing the desired drive mode. A drive mode status indicator will appear in the instrument cluster display → page 134. You can also

double push on the RHO button to go directly to Custom Mode → page 266.

NOTE:

The selected drive mode will be applied once the instrument cluster pop-up times out due to lack of additional presses of the **left** ◀ or **right** ▶ arrow button → page 262.

BATTERY SAVER ON/BATTERY SAVER MODE MESSAGE — ELECTRICAL LOAD REDUCTION ACTIONS — IF EQUIPPED

3

This vehicle is equipped with an Intelligent Battery Sensor (IBS) to perform additional monitoring of the electrical system and status of the vehicle battery.

In cases when the IBS detects charging system failure, or the vehicle battery conditions are deteriorating, electrical load reduction actions will take place to extend the driving time and distance of the vehicle. This is done by reducing power to or turning off non-essential electrical loads.

Load reduction is only active when the engine is running. It will display a message if there is a risk of battery depletion to the point where the vehicle may stall due to lack of electrical supply, or will not restart after the current drive cycle.

When load reduction is activated, the message “Battery Saver On Some Systems May Have Reduced Power” will appear in the instrument cluster.

These messages indicate the vehicle battery has a low state of charge and continues to lose electrical charge at a rate that the charging system cannot sustain.

NOTE:

- The charging system is independent from load reduction. The charging system performs a diagnostic on the charging system continuously.
- If the Battery Charge Warning Light is on it may indicate a problem with the charging system → page 127.

The following are electrical loads that may be switched off (if equipped), and vehicle functions which can be affected by load reduction:

- Heated Seats / Vented Seats / Heated Wheel
- Rear Defroster And Heated Mirrors
- HVAC System
- 115 Volts AC Power Inverter System
- Audio and Telematics System

Loss of the battery charge may indicate one or more of the following conditions:

- The charging system cannot deliver enough electrical power to the vehicle system because the electrical loads are larger than the capability of charging system. The charging system is still functioning properly.
- Turning on all possible vehicle electrical loads (e.g. HVAC to max settings, exterior and interior lights, overloaded power outlets +12 Volts, 115 Volts AC, USB ports) during certain driving conditions (city driving, towing, frequent stopping).
- Installing options like additional lights, upfitter electrical accessories, audio systems, alarms and similar devices.

- Unusual driving cycles (short trips separated by long parking periods).
- The vehicle was parked for an extended period of time (weeks, months).
- The battery was recently replaced and was not charged completely.
- The battery was discharged by an electrical load left on when the vehicle was parked.
- The battery was used for an extended period with the engine not running to supply radio, lights, chargers, +12 Volt portable appliances like vacuum cleaners, game consoles and similar devices.

What to do when an electrical load reduction action message is present (“Battery Saver On” or “Battery Saver Mode”)

During a trip:

- Reduce power to unnecessary loads if possible:
 - Turn off redundant lights (interior or exterior).
 - Check what may be plugged in to power outlets +12 Volts, 115 Volts AC, USB ports.
 - Check HVAC settings (blower, temperature).
 - Check the audio settings (volume).

After a trip:

- Check if any aftermarket equipment was installed (additional lights, upfitter electrical accessories, audio systems, alarms) and review specifications if any (load and Ignition Off Draw currents).

- Evaluate the latest driving cycles (distance, driving time and parking time).
- The vehicle should have service performed if the message is still present during consecutive trips and the evaluation of the vehicle and driving pattern did not help to identify the cause.

WARNING LIGHTS AND MESSAGES

The warning/indicator lights will illuminate in the instrument panel together with a dedicated message and/or acoustic signal when applicable. These indications are indicative and precautionary and as such must not be considered as exhaustive and/or alternative to the information contained in the Owner’s Manual, which you are advised to read carefully in all cases. Always refer to the information in this chapter in the event of a failure indication. All active telltales will display first if applicable. The system check menu may appear different based upon equipment options and current vehicle status. Some telltales are optional and may not appear.

RED WARNING LIGHTS

Air Bag Warning Light



This warning light will illuminate to indicate a fault with the air bag, and will turn on for four to eight seconds as a bulb check when the ignition is placed in the ON/RUN or ACC/ON/RUN position. This light will illuminate with a single chime when a fault with the air bag has been detected, it will stay on until the fault is cleared. If the light is either not on during startup, stays on, or

turns on while driving, have the system inspected at an authorized dealer as soon as possible.

Brake Warning Light

BRAKE This warning light monitors various brake functions, including brake fluid level and parking brake application. If the brake light turns on it may indicate that the parking brake is applied, that the brake fluid level is low, or that there is a problem with the Anti-Lock Brake System reservoir.

If the light remains on when the parking brake has been disengaged, and the fluid level is at the full mark on the master cylinder reservoir, it indicates a possible brake hydraulic system malfunction.

The dual brake system provides a reserve braking capacity in the event of a failure to a portion of the hydraulic system. A leak in either half of the dual brake system is indicated by the Brake Warning Light, which will turn on when the brake fluid level in the master cylinder has dropped below a specified level.

The light will remain on until the cause is corrected.

NOTE:

The light may flash momentarily during sharp cornering maneuvers, which change fluid level conditions. The vehicle should have service performed, and the brake fluid level checked.

If brake failure is indicated, immediate repair is necessary.

WARNING!

Driving a vehicle with the red brake light on is dangerous. Part of the brake system may have failed. It will take longer to stop the vehicle. You could have a collision. Have the vehicle checked immediately.

Vehicles equipped with the Anti-Lock Brake System (ABS) are also equipped with Electronic Brake Force Distribution (EBD). In the event of an EBD failure, the Brake Warning Light will turn on along with the ABS Light. Immediate repair to the ABS system is required.

Operation of the Brake Warning Light can be checked by turning the ignition switch from the OFF position to the ON/RUN position. The light should illuminate for approximately two seconds. The light should then turn off unless the parking brake is applied or a brake fault is detected. If the light does not illuminate, have the light inspected by an authorized dealer.

The light also will turn on when the parking brake is applied with the ignition switch in the ON/RUN position.

NOTE:

This light shows only that the parking brake is applied. It does not show the degree of brake application.

Battery Charge Warning Light



This warning light will illuminate when the battery is not charging properly. If it stays on while the engine is running, there may be a malfunction with the charging system. Contact an authorized dealer as soon as possible.

This indicates a possible problem with the electrical system or a related component.

Door Open Warning Light



This indicator will illuminate when a door is ajar/open and not fully closed.

NOTE:

If the vehicle is moving there will also be a single chime.

Electric Power Steering (EPS) Fault Warning Light



This warning light will turn on when there's a fault with the EPS system → page 163.

WARNING!

Continued operation with reduced assist could pose a safety risk to yourself and others. Service should be obtained as soon as possible.

Electronic Throttle Control (ETC) Warning Light



This warning light will illuminate to indicate a problem with the ETC system. If a problem is detected while the vehicle is running, the light will either stay on or flash depending on the nature of the problem. Cycle the ignition when the vehicle is safely and completely stopped and the transmission is placed in the PARK position. The light should turn off. If the light remains on with the vehicle running, your vehicle will usually be drivable;

however, see an authorized dealer for service as soon as possible.

NOTE:

This light may turn on if the accelerator and brake pedals are pressed at the same time.

If the light continues to flash when the vehicle is running, immediate service is required and you may experience reduced performance, an elevated/rough idle, or engine stall and your vehicle may require towing. The light will come on when the ignition is placed in the ON/RUN or ACC/ON/RUN position and remain on briefly as a bulb check. If the light does not come on during starting, have the system checked by an authorized dealer.

Engine Coolant Temperature Warning Light



This warning light warns of an overheated engine condition. If the engine coolant temperature is too high, this indicator will illuminate and a single chime will sound. If the temperature reaches the upper limit, a continuous chime will sound for four minutes or until the engine is able to cool, whichever comes first.

If the light turns on while driving, safely pull over and stop the vehicle. If the Air Conditioning (A/C) system is on, turn it off. Also, shift the transmission into NEUTRAL (N) and idle the vehicle. If the temperature reading does not return to normal, turn the engine off immediately and call for service → page 344.

Hood Open Warning Light



This warning light will illuminate when the hood is ajar/open and not fully closed.

NOTE:

If the vehicle is moving, there will also be a single chime.

Oil Pressure Warning Light



This warning light will illuminate, and a chime will sound, to indicate low engine oil pressure. If the light and chime turn on while driving, safely stop the vehicle and turn off the engine as soon as possible. After the vehicle is safely stopped, restart the engine and monitor the Oil Pressure Warning Light. If the Oil Pressure Warning Light is still illuminated, turn the engine OFF and contact an authorized dealer for further assistance. Do not operate the vehicle until the cause is corrected. If the light is no longer illuminated, the engine can be operated but it is recommended to take the vehicle to an authorized dealer as soon as possible.

Do not operate the vehicle until the cause is corrected. This light does not indicate how much oil is in the engine. The engine oil level must be checked under the hood.

Oil Temperature Warning Light



This warning light will illuminate to indicate the engine oil temperature is high. If the light turns on while driving, stop the vehicle and shut off the engine as soon as possible. Wait for oil temperature to return to normal levels.

Seat Belt Reminder Warning Light



This warning light indicates when the driver or passenger seat belt is unbuckled. When the ignition is first placed in the ON/RUN or ACC/ON/RUN position and if the driver's seat belt is unbuckled, a chime will sound and the light will turn on. When driving, if the driver or front passenger seat belt remains unbuckled, the Seat Belt Reminder Light will flash or remain on continuously and a chime will sound → page 302.

Tailgate Open Warning Light



This warning light will illuminate when the tailgate is open.

NOTE:

If the vehicle is moving, there will also be a single chime.

Trailer Brake Disconnected Warning Light



This warning light will illuminate when the Trailer Brake has been disconnected.

Transmission Temperature Warning Light – If Equipped



This warning light will illuminate to warn of a high transmission fluid temperature. This may occur with strenuous usage such as trailer towing. If this light turns on, stop the vehicle and run the engine at idle or slightly faster, with the transmission in PARK or NEUTRAL, until the light

turns off. Once the light turns off, you may continue to drive normally.

WARNING!

If you continue operating the vehicle when the Transmission Temperature Warning Light is illuminated you could cause the fluid to boil over, come in contact with hot engine or exhaust components and cause a fire.

CAUTION!

Continuous driving with the Transmission Temperature Warning Light illuminated will eventually cause severe transmission damage or transmission failure.

Vehicle Security Warning Light — If Equipped



This light will flash at a fast rate for approximately 15 seconds when the vehicle security system is arming, and then will flash slowly until the vehicle is disarmed.

YELLOW WARNING LIGHTS

Active Driving Assist Fault Warning Light



This light will turn on when the Active Driving Assist system has detected a fault.

Adaptive Cruise Control (ACC) Fault Warning Light — If Equipped



This warning light will illuminate to indicate a fault in the ACC system. Contact an authorized dealer for service → page 166.

Air Suspension Fault Warning Light — If Equipped



This light will illuminate when a fault is detected with the air suspension system.

Anti-Lock Brake System (ABS) Warning Light



This warning light monitors the ABS. The light will turn on when the ignition is placed in the ON/RUN or ACC/ON/RUN position and may stay on for as long as four seconds.

If the ABS light remains on or turns on while driving, then the Anti-Lock portion of the brake system is not functioning and service is required as soon as possible. However, the conventional brake system will continue to operate normally, assuming the Brake Warning Light is not also on.

If the ABS light does not turn on when the ignition is placed in the ON/RUN or ACC/ON/RUN position, have the brake system inspected by an authorized dealer.

Electric Park Brake Warning Light



This warning light will illuminate to indicate the Electric Park Brake is not functioning properly and service is required. Contact an authorized dealer.

Electronic Stability Control (ESC) Active Warning Light — If Equipped



This warning light will indicate when the ESC system is Active. The ESC Indicator Light in the instrument cluster will come on when the ignition is placed in the ON/RUN or ACC/ON/RUN position, and when ESC is activated. It should go out with the engine running. If the ESC Indicator Light comes on continuously with the engine running, a malfunction has been detected in the ESC system. If this warning light remains on after several ignition cycles, and the vehicle has been driven several miles (kilometers) at speeds greater than 30 mph (48 km/h), see an authorized dealer as soon as possible to have the problem diagnosed and corrected.

- The ESC OFF Indicator Light and the ESC Indicator Light come on momentarily each time the ignition is placed in the ON/RUN or ACC/ON/RUN position.
- The ESC system will make buzzing or clicking sounds when it is active. This is normal; the sounds will stop when ESC becomes inactive.
- This light will come on when the vehicle is in an ESC event.

Electronic Stability Control (ESC) OFF Warning Light — If Equipped



This warning light indicates the ESC is off.

Each time the vehicle is placed in ON/RUN or ACC/ON/RUN, the ESC system will be on, even if it was turned off previously.

Fuel Level Sensor Failure Warning Light - If Equipped



This warning light will illuminate along with a dedicated message on the display if a problem is detected with the Fuel Level Sensor. If this light comes on see an authorized dealer immediately.

Low Fuel Warning Light



When the fuel level is less than a quarter tank, and the Distance to Empty is less than 50 miles (80 km), this light will turn on and remain on until fuel is added.

A single warning chime will sound with Low Fuel Warning.

Low Washer Fluid Warning Light — If Equipped



This warning light will illuminate when the windshield washer fluid is low.

Engine Check/Malfunction Indicator Warning Light (MIL)



The MIL is a part of an Onboard Diagnostic System called OBD II that monitors engine and automatic transmission control systems. This warning light will illuminate when the ignition is in the ON/RUN position before engine start. If the bulb does not come on when turning the ignition switch from OFF to ON/RUN, have the condition checked promptly.

Certain conditions, such as a loose or missing gas cap, poor quality fuel, etc., may illuminate the light after engine start. The vehicle should be serviced if the light stays on through several typical driving styles. In most situations, the vehicle will drive normally and will not require towing.

When the engine is running, the MIL may flash to alert serious conditions that could lead to immediate loss of power or severe catalytic converter damage. The vehicle should be serviced by an authorized dealer as soon as possible if this occurs.

WARNING!

A malfunctioning catalytic converter can reach higher temperatures than in normal operating conditions. This can cause a fire if you drive slowly or park over flammable substances such as dry plants, wood, cardboard, etc. This could result in death or serious injury to the driver, occupants or others.

CAUTION!

Prolonged driving with the Malfunction Indicator Light (MIL) on could cause damage to the vehicle control system. It also could affect fuel economy and driveability. If the MIL is flashing, severe catalytic converter damage and power loss will soon occur. Immediate service is required.

Rear Axle Locker Fault Warning Light — If Equipped



This warning light will illuminate to indicate when a rear axle locker fault has been detected.

Service Forward Collision Warning (FCW) Light — If Equipped



This warning light will illuminate to indicate a fault in the FCW System. Contact an authorized dealer for service → page 294.

Service Stop/Start System Warning Light — If Equipped



This warning light will illuminate when the Stop/Start system is not functioning properly and service is required. Contact an authorized dealer for service.

Service 4WD Warning Light – If Equipped

**SERV
4WD**

This warning light will illuminate to signal a fault with the 4WD system. If the light stays on or comes on during driving, it means that the 4WD system is not functioning properly and that service is required. We recommend you drive to the nearest authorized dealer and have the vehicle serviced immediately.

Cruise Control Fault Warning Light



This warning light will illuminate to indicate the Cruise Control System is not functioning properly and service is required. Contact an authorized dealer.

Tire Pressure Monitoring System (TPMS) Warning Light



The warning light switches on and a message is displayed to indicate that the tire pressure is lower than the recommended value and/or that slow pressure loss is occurring. In these cases, optimal tire duration and fuel consumption may not be guaranteed.

Should one or more tires be in the condition previously mentioned, the display will show the indications corresponding to each tire.

CAUTION!

Do not continue driving with one or more flat tires as handling may be compromised. Stop the vehicle,

(Continued)

CAUTION!

avoiding sharp braking and steering. If a tire puncture occurs, repair immediately using the dedicated tire repair kit and contact an authorized dealer as soon as possible.

Each tire, including the spare (if provided), should be checked monthly when cold and inflated to the inflation pressure recommended by the vehicle manufacturer on the vehicle placard or tire inflation pressure label. If your vehicle has tires of a different size than the size indicated on the vehicle placard or tire inflation pressure label, you should determine the proper tire inflation pressure for those tires.

As an added safety feature, your vehicle has been equipped with a TPMS that illuminates a low tire pressure telltale when one or more of your tires is significantly underinflated. Accordingly, when the low tire pressure telltale illuminates, you should stop and check your tires as soon as possible, and inflate them to the proper pressure. Driving on a significantly underinflated tire causes the tire to overheat and can lead to tire failure. Underinflation also reduces fuel efficiency and tire tread life, and may affect the vehicle's handling and stopping ability.

Please note that the TPMS is not a substitute for proper tire maintenance, and it is the driver's responsibility to maintain correct tire pressure, even if underinflation has not reached the level to trigger illumination of the TPMS low tire pressure telltale.

Your vehicle has also been equipped with a TPMS malfunction indicator to indicate when the system is not operating properly. The TPMS malfunction indicator is combined with the low tire pressure

telltale. When the system detects a malfunction, the telltale will flash for approximately one minute and then remain continuously illuminated. This sequence will continue upon subsequent vehicle start-ups as long as the malfunction exists. When the malfunction indicator is illuminated, the system may not be able to detect or signal low tire pressure as intended. TPMS malfunctions may occur for a variety of reasons, including the installation of replacement or alternate tires or wheels on the vehicle that prevent the TPMS from functioning properly. Always check the TPMS malfunction telltale after replacing one or more tires or wheels on your vehicle to ensure that the replacement or alternate tires and wheels allow the TPMS to continue to function properly.

CAUTION!

The TPMS has been optimized for the original equipment tires and wheels. TPMS pressures and warning have been established for the tire size equipped on your vehicle. Undesirable system operation or sensor damage may result when using replacement equipment that is not of the same size, type, and/or style. Aftermarket wheels can cause sensor damage. Using aftermarket tire sealants may cause the Tire Pressure Monitoring System (TPMS) sensor to become inoperable. After using an aftermarket tire sealant it is recommended that you take your vehicle to an authorized dealer to have your sensor function checked.

Traffic Sign Recognition (TSR) Fault Warning Light



This light will illuminate to indicate a TSR fault. Contact an authorized dealer if the light remains on after restarting vehicle.

YELLOW INDICATOR LIGHTS

Air Suspension Aerodynamic Height Indicator Light — If Equipped



This light will illuminate when the air suspension system is set to the Aerodynamic setting.

Air Suspension Normal Height Indicator Light — If Equipped



This light will illuminate when the air suspension system is set to the Normal setting → page 157.

Air Suspension Off-Road 1 Indicator Light — If Equipped



This light will illuminate when the air suspension system is set to the Off-Road 1 setting → page 157.

Air Suspension Off-Road 2 Indicator Light — If Equipped



This light will illuminate when the air suspension system is set to the Off-Road 2 setting → page 157.

Air Suspension Payload Protection Indicator Light — If Equipped



This indicator light will illuminate to indicate that the maximum payload may have been exceeded or load leveling cannot be achieved at its current ride height.

Protection mode will automatically be selected to “protect” the air suspension system. Air suspension adjustment is limited due to payload.

Air Suspension Ride Height Raising Indicator Light — If Equipped



This light will blink and alert the driver that the vehicle is changing to a higher ride height.

Air Suspension Ride Height Lowering Indicator Light — If Equipped



This light will blink and alert the driver that the vehicle is changing to a lower ride height.

Cargo Light On Indicator Light — If Equipped



This indicator light will illuminate when the cargo light is activated by pushing the cargo light button on the headlight switch.

Forward Collision Warning (FCW) Off Indicator Light — If Equipped



This indicator light illuminates to indicate that Forward Collision Warning is off.

NEUTRAL Indicator Light — If Equipped



This light alerts the driver that the 4WD power transfer case is in the NEUTRAL mode and the front and rear driveshafts are disengaged from the powertrain.

Rear Axle Lock Indicator Light



This light indicates when the rear axle lock has been activated.

Entry/Exit Indicator Light — If Equipped



This light will illuminate when the vehicle is automatically lowered from ride height position downward for easy entry and exit of the vehicle → page 157.

TOW/HAUL Indicator Light - If Equipped



This indicator light will illuminate when TOW/HAUL mode is selected.

Trailer Merge Assist Indicator Light — If Equipped



This indicator light will illuminate to indicate when Trailer Merge Assist has been activated → page 289.

4WD High Indicator Light — If Equipped



This light alerts the driver that the vehicle is in the 4WD High mode. The front and rear driveshafts are mechanically locked together forcing the front and rear wheels to rotate at the same speed.

4WD Indicator Light — If Equipped



This light alerts the driver that the vehicle is in the four-wheel drive mode, and the front and rear driveshafts are mechanically locked together forcing the front and rear wheels to rotate at the same speed.

4WD Low Indicator Light — If Equipped



This light alerts the driver that the vehicle is in the 4WD Low mode. The front and rear driveshafts are mechanically locked together forcing the front and rear wheels to rotate at the same speed. Low range provides a greater gear reduction ratio to provide increased torque at the wheels → page 147.

GREEN INDICATOR LIGHTS

Adaptive Cruise Control (ACC) Set With Target Indicator Light — If Equipped



This will display when the ACC is set and a vehicle in front is detected → page 166.

Adaptive Cruise Control (ACC) Set With No Target Detected Indicator Light — If Equipped



This light will turn on when the ACC is set and there is no vehicle in front detected → page 166.

ECO Mode Indicator Light - If Equipped



This light will turn on when ECO mode, if equipped, is active.

Front Fog Indicator Light — If Equipped



This indicator light will illuminate when the front fog lights are on.

Parking/Headlights On Indicator Light



This indicator light will illuminate when the parking lights or headlights are turned on.

Turn Signal Indicator Lights



When the left or right turn signal is activated, the turn signal indicator will flash independently and the corresponding exterior turn signal lamps will flash. Turn signals can be activated when the multifunction lever is moved down (left) or up (right).

NOTE:

- A continuous chime will sound if the vehicle is driven more than 1 mile (1.6 km) with either turn signal on.
- Check for an inoperative outside light bulb if either indicator flashes at a rapid rate.
- If equipped with fog lamps, the fog lamp on the side of the activated turn signal will also illuminate to provide additional light when turning.

Cruise Control SET Indicator Light — If Equipped With Premium Instrument Cluster Display



This light will turn on when the cruise control is set → page 166.

Stop/Start Active Indicator Light — If Equipped



This indicator light will illuminate when the Stop/Start function is in "Autostop" mode → page 164.

4WD AUTO Indicator Light — If Equipped

This light alerts the driver that the vehicle is in the four-wheel drive auto mode, and the front axle is engaged, but the vehicle's power is sent to the rear wheels. Four-wheel drive will be automatically engaged when the vehicle senses a loss of traction → page 147.

DRIVE MODE INDICATOR LIGHTS**Baja Mode Indicator Light**

This light will turn on when Baja mode is active → page 266.

Custom Mode Indicator Light

This light will turn on when Custom mode is active → page 266.

Mud/Sand Mode Indicator Light

This light will turn on when Mud/Sand mode is active → page 266.

Rock Mode Indicator Light

This light will turn on when Rock mode is active → page 266.

Snow Mode Indicator Light

This light will turn on when Snow mode is active → page 264.

Sport Mode Indicator Light

This light will turn on when Sport mode is active → page 263.

Tow Mode Indicator Light

This light will turn on when Tow mode is active → page 264.

Valet Mode Indicator Light

This light will turn on when Valet mode is active → page 274.

WHITE INDICATOR LIGHTS**Adaptive Cruise Control (ACC) Ready Indicator Light — If Equipped**

This light will illuminate when the vehicle equipped with ACC has been turned on but not set → page 166.

Cruise Control Ready Indicator Light

This indicator light will illuminate when the cruise control is ready, but not set → page 166.

Cruise Control SET Indicator Light — If Equipped With Base/Midline Instrument Cluster Display

This light will turn on when the cruise control is set → page 166.

Selec-Speed Control (SSC) Indicator Light — If Equipped

This indicator shows when the SSC feature is turned on. The light will be on solid when SSC is armed. SSC can only be armed when the transfer case is in the “4WD Low” position and the vehicle speed is less than 20 mph (32 km/h). If these conditions are not met while attempting to use the SSC feature, the SSC indicator light will flash on/off.

BLUE INDICATOR LIGHTS**High Beam Indicator Light**

This indicator light will illuminate to indicate that the high beam headlights are on. With the low beams activated, push the multifunction lever forward (toward the front of the vehicle) to turn on the high beams. Pull the multifunction lever rearward (toward the rear of the

vehicle) to turn off the high beams. If the high beams are off, pull the lever toward you for a temporary high beam on, “flash to pass” scenario.

ONBOARD DIAGNOSTIC SYSTEM — OBD II

Your vehicle is equipped with a sophisticated Onboard Diagnostic system called OBD II. This system monitors the performance of the emissions, engine, and transmission control systems. When these systems are operating properly, your vehicle will provide excellent performance and fuel economy, as well as engine emissions well within current government regulations.

If any of these systems require service, the OBD II system will turn on the Malfunction Indicator Light (MIL). It will also store diagnostic codes and other information to assist your service technician in making repairs. Although your vehicle will usually be drivable and not need towing, see an authorized dealer for service as soon as possible.

CAUTION!

- Prolonged driving with the MIL on could cause further damage to the emission control system. It could also affect fuel economy and driveability. The vehicle must be serviced before any emissions tests can be performed.
- If the MIL is flashing while the vehicle is running, severe catalytic converter damage and power loss will soon occur. Immediate service is required.

ONBOARD DIAGNOSTIC SYSTEM (OBD II) CYBERSECURITY

Your vehicle is required to have OBD II and a connection port to allow access to information related to the performance of your emissions controls. Authorized service technicians may need to access this information to assist with the diagnosis and service of your vehicle and emissions system → page 227.

WARNING!

- ONLY an authorized service technician should connect equipment to the OBD II connection port in order to read the VIN, diagnose, or service your vehicle.
- If unauthorized equipment is connected to the OBD II connection port, such as a driver-behavior tracking device, it may:
 - Be possible that vehicle systems, including safety related systems, could be impaired or a loss of vehicle control could occur that may result in an accident involving serious injury or death.
 - Access, or allow others to access, information stored in your vehicle systems, including personal information.

EMISSIONS INSPECTION AND MAINTENANCE PROGRAMS

In some localities, it may be a legal requirement to pass an inspection of your vehicle's emissions control system. Failure to pass could prevent vehicle registration.



For states that require an Inspection and Maintenance (I/M), this check verifies the Malfunction Indicator Light (MIL) is functioning and is not on when the engine is running, and that the OBD II system is ready for testing.

Normally, the OBD II system will be ready. The OBD II system may **not** be ready if your vehicle was recently serviced, recently had a depleted battery or a battery replacement. If the OBD II system should be determined not ready for the I/M test, your vehicle may fail the test.

Your vehicle has a simple ignition actuated test, which you can use prior to going to the test station. To check if your vehicle's OBD II system is ready, you must do the following:

1. Cycle the ignition switch to the ON position, but do not crank or start the engine.

NOTE:

If you crank or start the engine, you will have to start this test over.

2. As soon as you cycle the ignition switch to the ON position, you will see the Malfunction Indicator Light (MIL) symbol come on as part of a normal bulb check.

3. Approximately 15 seconds later, one of two things will happen:
- The MIL will flash for about 10 seconds and then return to being fully illuminated until you turn OFF the ignition or start the engine. This means that your vehicle's OBD II system is **not ready** and you should **not** proceed to the I/M station.
 - The MIL will not flash at all and will remain fully illuminated until you place the ignition in the off position or start the engine. This means that your vehicle's OBD II system is **ready** and you can proceed to the I/M station.

If your OBD II system is **not ready**, you should see an authorized dealer or repair facility. If your vehicle was recently serviced or had a battery failure or replacement, you may need to do nothing more than drive your vehicle as you normally would in order for your OBD II system to update. A recheck with the approved test routine may then indicate that the system is **now ready**.

Regardless of whether your vehicle's OBD II system is ready or not, if the MIL is illuminated during normal vehicle operation you should have your vehicle serviced before going to the I/M station. The I/M station can fail your vehicle because the MIL is on with the engine running.

STARTING AND OPERATING

STARTING THE ENGINE

Before starting your vehicle, adjust your seat, adjust both inside and outside mirrors, and fasten your seat belt.

The starter should not be operated for more than 10-second intervals. Waiting at least 10 to 15 seconds between such intervals will protect the starter from overheating.

WARNING!

- When leaving the vehicle, always make sure the keyless ignition node is in the OFF position, remove the key fob from the vehicle and lock the vehicle.
- Never leave children alone in a vehicle, or with access to an unlocked vehicle. Allowing children to be in a vehicle unattended is dangerous for a number of reasons. A child or others could be seriously or fatally injured. Children should be warned not to touch the parking brake, brake pedal or the gear selector.
- Do not leave the key fob in or near the vehicle, or in a location accessible to children, and do not leave the ignition of a vehicle equipped with Keyless Enter 'n Go™ in the ON/RUN position. A child could operate power windows, other controls, or move the vehicle.

(Continued)

WARNING!

- Do not leave children or animals inside parked vehicles in hot weather. Interior heat buildup may cause serious injury or death.

AUTOMATIC TRANSMISSION

Start the engine with the transmission in PARK position. Apply the brake before shifting into any driving range.

NOTE:

- This vehicle is equipped with a transmission shift interlocking system. The brake pedal must be pressed to shift out of PARK.
- If equipped with an 8-speed transmission, starting the vehicle in NEUTRAL is not possible unless the Manual Park Release has been activated ➡ page 345.

AUTOPARK

AutoPark is a supplemental feature to assist with placing the vehicle in PARK should the situations on the following pages occur. It is a back-up system and should not be relied upon as the primary method by which the driver shifts the vehicle into PARK.

The conditions under which AutoPark will engage are outlined on the following pages.

WARNING!

- Driver inattention could lead to failure to place the vehicle in PARK. ALWAYS DO A VISUAL CHECK that your vehicle is in PARK by verifying that a solid (not blinking) "P" is indicated in the instrument cluster display and near the gear selector. If the "P" indicator is blinking, your vehicle is not in PARK. As an added precaution, always apply the parking brake when exiting the vehicle.
- AutoPark is a supplemental feature. It is not designed to replace the need to shift your vehicle into PARK. It is a back up system and should not be relied upon as the primary method by which the driver shifts the vehicle into PARK.

If the vehicle is not in PARK and the driver turns off the engine, the vehicle may AutoPark.

AutoPark will engage when all of these conditions are met:

- Vehicle is equipped with a rotary shifter and an 8-speed transmission
- Vehicle is not in PARK
- Vehicle speed is 1.2 mph (1.9 km/h) or less

NOTE:

For Keyless Enter 'n Go™ equipped vehicles, after 30 minutes the ignition switches to OFF automatically, unless the driver turns the ignition switch OFF.

If the vehicle is not in PARK and the driver exits the vehicle with the engine running, the vehicle may AutoPark.

AutoPark will engage when all of these conditions are met:

- Vehicle is equipped with a rotary shifter and an 8-speed transmission
- Vehicle is not in PARK
- Vehicle speed is 1.2 mph (1.9 km/h) or less
- Driver's seat belt is unbuckled
- Driver's door is ajar
- Brake pedal is not pressed

The message “**AutoPark Engaged Shift To P Then Shift To Gear**” will display in the instrument cluster.

NOTE:

In some cases the ParkSense graphic will be displayed in the instrument cluster, causing the “**AutoPark Engaged Shift To P Then Shift To Gear**” message to not be seen. In these cases, the gear selector must be returned to “P” to select desired gear.

If the driver shifts into PARK while moving, the vehicle may AutoPark.

AutoPark will engage **ONLY** when vehicle speed is 1.2 mph (1.9 km/h) or less.

The message “**Vehicle Speed Is Too High To Shift to P**” will be displayed in the instrument cluster if vehicle speed is above 1.2 mph (1.9 km/h).

WARNING!

If vehicle speed is above 1.2 mph (1.9 km/h), the transmission will default to NEUTRAL until the vehicle speed drops below 1.2 mph (1.9 km/h). A vehicle left in the NEUTRAL position can roll. As an added precaution, always apply the parking brake when exiting the vehicle.

4WD LOW — If Equipped

AutoPark will be disabled when operating the vehicle in 4WD LOW.

The message “**AutoPark Disabled**” will be displayed in the instrument cluster.

Additional customer warnings will be given when all of these conditions are met:

- Vehicle is not in PARK
- Driver's door is ajar
- Vehicle is in 4WD LOW

The message “**AutoPark Not Engaged**” will be displayed in the instrument cluster. A warning chime will continue until you shift the vehicle into PARK or the driver's door is closed.

ALWAYS DO A VISUAL CHECK that your vehicle is in PARK by looking for the “P” in the instrument cluster display and near the gear selector. As an added precaution, always apply the parking brake when exiting the vehicle.

TIP START FEATURE

Do not press the accelerator. Cycle the ignition switch briefly to the START position and release it. The starter motor will continue to run and will automatically disengage when the engine is running.

KEYLESS ENTER ‘N GO™ — IGNITION

This feature allows the driver to operate the ignition switch with the push of a button, as long as the Remote Start/Keyless Enter ‘n Go™ key fob is in the passenger compartment.

NORMAL STARTING USING ENGINE START/STOP BUTTON

To Turn On The Engine Using The ENGINE START/STOP Button

1. The transmission must be in PARK.
2. Press and hold the brake pedal while pushing the ENGINE START/STOP button once.
3. The system starts the vehicle. If the vehicle fails to start, the starter will disengage automatically after 10 seconds.
4. If you wish to stop the cranking of the engine prior to the engine starting, push the button again.

To Turn Off The Engine Using The ENGINE START/STOP Button

1. Place the gear selector in PARK, then push and release the ENGINE START/STOP button. The ignition will return to the OFF position.

- If the gear selector is not in PARK, the ENGINE START/STOP button must be held for two seconds or three short pushes in a row with the vehicle speed above 5 mph (8 km/h) before the engine will shut off. The ignition will remain on until the gear selector is in PARK and the button is pushed twice to the OFF position.
- If the gear selector is not in PARK and the ENGINE START/STOP button is pushed once with the vehicle speed above 5 mph (8 km/h), the instrument cluster will display a “**Vehicle Not In Park**” message and the engine will remain running. Never leave a vehicle out of the PARK position, or it could roll.

NOTE:

If the gear selector is not in PARK, and the ENGINE START/STOP button is pushed once with the vehicle speed below 5 mph (8 km/h), the engine will shut off and the ignition will remain on. If vehicle speed drops below 1.2 mph (1.9 km/h), the vehicle may AutoPark  page 137.

ENGINE START/STOP Button Functions – With Driver’s Foot Off The Brake Pedal (In PARK Or NEUTRAL Position)

The ENGINE START/STOP button operates similar to an ignition switch. It has two positions: OFF, and ON/RUN. To change the ignition positions without starting the vehicle and use the accessories, follow these directions:

- Start with the ignition in the OFF position.
- Push the ENGINE START/STOP button once to place the ignition to the ON/RUN position.

- Push the ENGINE START/STOP button a second time to place the ignition to the OFF position.

EXTENDED PARK STARTING**NOTE:**

Extended Park condition occurs when the vehicle has not been started or driven for at least 30 days.

- Install a battery charger or jumper cables to the battery to ensure a full battery charge during the crank cycle.
- Place the ignition to the START position and release it when the engine starts. For Keyless Enter ‘n Go™ ignition systems, press and hold the brake pedal while pushing the ENGINE START/STOP button once.
- If the engine fails to start within 10 seconds, wait 10 to 15 seconds to allow the starter to cool, then repeat the Extended Park Starting procedure.
- If the engine fails to start after eight attempts, allow the starter to cool for at least 10 minutes, then repeat the Extended Park Starting procedure.

CAUTION!

To prevent damage to the starter, do not crank continuously for more than 10 seconds at a time. Wait 10 to 15 seconds before trying again.

IF ENGINE FAILS TO START

If the engine fails to start after you have followed the “Normal Starting” procedure and the vehicle has not experienced an Extended Park condition as defined

above, it may be flooded. Push the accelerator pedal all the way to the floor and hold it there while the engine is cranking. This should clear any excess fuel in case the engine is flooded.

The starter motor will engage automatically, run for 10 seconds, and then disengage. Once this occurs, release the accelerator pedal and the brake pedal, wait 10 to 15 seconds, then repeat the “Normal Starting” procedure.

WARNING!

- Never pour fuel or other flammable liquid into the throttle body air inlet opening in an attempt to start the vehicle. This could result in flash fire causing serious personal injury.
- Do not attempt to push or tow your vehicle to get it started. Vehicles equipped with an automatic transmission cannot be started this way. Unburned fuel could enter the catalytic converter and once the engine has started, ignite and damage the converter and vehicle.
- If the vehicle has a discharged battery, booster cables may be used to obtain a start from a booster battery or the battery in another vehicle. This type of start can be dangerous if done improperly.

CAUTION!

To prevent damage to the starter, do not crank the engine for more than 10 seconds at a time. Wait 10 to 15 seconds before trying again.

If the engine has been flooded, it may start to run, but not have enough power to continue running when the ignition button/key is released. If this occurs, continue cranking with the accelerator pedal pushed all the way to the floor. Release the accelerator pedal and the ignition button/key once the engine is running smoothly.

If the engine shows no sign of starting after a 10 second period of engine cranking with the accelerator pedal held to the floor, wait 10 to 15 seconds, then repeat the "Normal Starting" procedure.

AFTER STARTING

The idle speed is controlled automatically, and it will decrease as the engine warms up.

ENGINE BLOCK HEATER — IF EQUIPPED

The engine block heater warms engine coolant and permits quicker starts in cold weather. Connect the heater cord to a ground-fault interrupter protected 110–115 Volt AC electrical outlet with a grounded, three-wire extension cord.

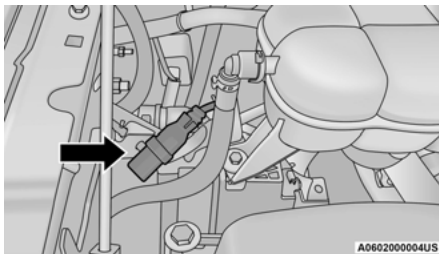

Engine Block Heater Cord Location

To ensure reliable starting at these temperatures, use of an externally powered electric engine block heater (available from an authorized dealer) is recommended.

The engine block heater cord is routed under the hood on the passenger side of the vehicle next to the engine coolant reservoir.

WARNING!

Remember to disconnect the engine block heater cord before driving. Damage to the 110-115 Volt electrical cord could cause electrocution.

ENGINE BREAK-IN RECOMMENDATIONS

A long break-in period is not required for the engine and drivetrain (transmission and axle) in your vehicle.

Drive moderately during the first 300 miles (500 km). After the initial 60 miles (100 km), speeds up to 50 or 55 mph (80 or 90 km/h) are desirable.

While cruising, brief full-throttle acceleration within the limits of local traffic laws contributes to a good break-in. Wide-open throttle acceleration in low gear can be detrimental and should be avoided.

The engine oil installed in the engine at the factory is a high-quality energy conserving type lubricant. Oil changes should be consistent with anticipated climate conditions under which vehicle operations will occur. For the recommended viscosity and quality grades  page 415.

CAUTION!

Never use Non-Detergent Oil or Straight Mineral Oil in the engine or damage may result.

NOTE:

A new engine may consume some oil during its first few thousand miles (kilometers) of operation. This should be considered a normal part of the break-in and not interpreted as a problem. Please check your oil level with the engine oil indicator often during the break-in period. Add oil as required.

PARKING BRAKE

ELECTRIC PARK BRAKE (EPB)

Your vehicle is equipped with an EPB that offers simple operation, and some additional features that make the parking brake more convenient and useful.

The parking brake is primarily intended to prevent the vehicle from rolling while parked. Before leaving the

vehicle, make sure that the parking brake is applied. Also, be certain to leave the transmission in PARK.

You can engage the parking brake in two ways:

- Manually, by applying the parking brake switch.
- Automatically, by enabling the Auto Park Brake feature in the Customer Programmable Features section of the Uconnect settings.

The parking brake switch is located on the instrument panel to the left of the steering wheel (below the headlamp switch).

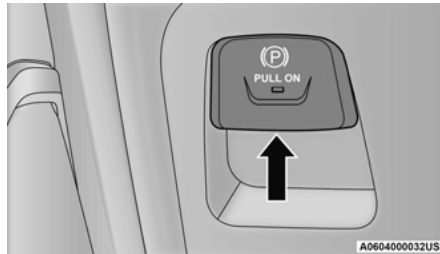

Electric Park Brake Switch

To apply the parking brake manually, pull up on the switch momentarily. You may hear a slight sound from the back of the vehicle while the parking brake engages. Once the park brake is fully engaged, the BRAKE telltale light in the instrument cluster and an indicator on the switch will illuminate. If your foot is on the brake pedal while you apply the parking brake, you may notice a small amount of brake pedal movement. The parking brake can be applied even when the ignition switch is OFF but the BRAKE telltale light will

not illuminate, however, it can only be released when the ignition is in the ON/RUN position.

NOTE:

The EPB Warning Light will illuminate if the EPB switch is held for longer than 20 seconds in either the released or applied position. The light will extinguish upon releasing the switch.

If the Auto Park Brake feature is enabled, the parking brake will automatically engage whenever the transmission is placed into PARK. If your foot is on the brake pedal, you may notice a small amount of brake pedal movement while the parking brake is engaging.

The parking brake will release automatically when the ignition is ON, the transmission is in DRIVE or REVERSE, the driver seat belt is buckled, and an attempt is made to drive away.

To release the parking brake manually, the ignition switch must be in the ON/RUN position. Put your foot on the brake pedal, then push the parking brake switch down momentarily. You may hear a slight whirring sound from the back of the vehicle while the parking brake disengages. You may also notice a small amount of movement in the brake pedal. Once the parking brake is fully disengaged, the BRAKE telltale light in the instrument cluster and the LED indicator on the switch will extinguish.

When parking on a hill, it is important to turn the front wheels toward the curb on a downhill grade and away from the curb on an uphill grade. Apply the parking brake before placing the gear selector in PARK, otherwise the load on the transmission locking mechanism may make it difficult to move the gear selector out of PARK.

WARNING!

- Never use the PARK position as a substitute for the parking brake. Always apply the parking brake fully when parked to guard against vehicle movement and possible injury or damage.
- When exiting the vehicle, always remove the key fob from the ignition and lock your vehicle.
- Never leave children alone in a vehicle, or with access to an unlocked vehicle. Allowing children to be in a vehicle unattended is dangerous for a number of reasons. A child or others could be seriously or fatally injured. Children should be warned not to touch the parking brake, brake pedal or the gear selector.
- Do not leave the key fob in or near the vehicle, or in a location accessible to children, and do not leave a vehicle equipped with Keyless Enter 'n Go™ in the ON/RUN position. A child could operate power windows, other controls, or move the vehicle.
- Be sure the parking brake is fully disengaged before driving; failure to do so can lead to brake failure and a collision.
- Always fully apply the parking brake when leaving your vehicle, or it may roll and cause damage or injury. Also be certain to leave the transmission in PARK. Failure to do so may allow the vehicle to roll and cause damage or injury.

CAUTION!

If the Brake System Warning Light remains on with the parking brake released, a brake system malfunction is indicated. Have the brake system serviced by an authorized dealer immediately.

If exceptional circumstances should make it necessary to engage the parking brake while the vehicle is in motion, maintain upward pressure on the EPB switch for as long as engagement is desired. The BRAKE telltale light will illuminate, and a continuous chime will sound. The rear stop lamps will also be illuminated automatically while the vehicle remains in motion.

To disengage the parking brake while the vehicle is in motion, release the switch. If the vehicle is brought to a complete stop using the parking brake, when the vehicle reaches approximately 3 mph, (5 km/h) the parking brake will remain engaged.

WARNING!

Driving the vehicle with the parking brake engaged, or repeated use of the parking brake to slow the vehicle, may cause serious damage to the brake system. Be sure the parking brake is fully disengaged before driving; failure to do so can lead to brake failure and a collision.

In the unlikely event of a malfunction of the EPB system, a yellow EPB Warning Light will illuminate. This may be accompanied by the BRAKE telltale light flashing. In this event, urgent service of the EPB system is required. Do not rely on the parking brake to hold the vehicle stationary.

Auto Park Brake

The Electric Park Brake (EPB) can be programmed to be applied automatically whenever the vehicle is at a standstill and the automatic transmission is placed in PARK. Auto Park Brake is enabled and disabled by customer selection through the Customer Programmable Features section of the Uconnect Settings  page 227.

Any single Auto Park Brake application can be bypassed by pushing the EPB switch to the release position while the transmission is placed in PARK.

SafeHold

SafeHold is a safety feature of the Electric Park Brake (EPB) system that will engage the parking brake automatically if the vehicle is left unsecured while the ignition is in ON/RUN.

The parking brake will automatically engage if all of the following conditions are met:

- The vehicle is at a standstill.
- There is no attempt to press the brake pedal and accelerator pedal.
- The seat belt is unbuckled.
- The driver door is open.

SafeHold can be temporarily bypassed by pushing the EPB switch while the driver door is open. Once manually bypassed, SafeHold will be enabled again once the vehicle reaches 12 mph (20 km/h) or the ignition is turned to the OFF position and back to ON again.

Brake Service Mode

We recommend having your brakes serviced by an authorized dealer. You should only make repairs for which you have the knowledge and the right equipment. You should only enter Brake Service mode during brake service.

When servicing your rear brakes, it may be necessary for you or your technician to push the rear piston into the rear caliper bore. With the Electric Park Brake (EPB) system, this can only be done after retracting the EPB actuator. Fortunately, actuator retraction can be done easily by entering the Brake Service mode through the Uconnect Settings in your vehicle. This menu-based system will guide you through the steps necessary to retract the EPB actuator in order to perform rear brake service.

Service Mode has requirements that must be met in order to be activated:

- The vehicle must be at a standstill.
- The parking brake must be unapplied.
- The transmission must be in PARK or NEUTRAL.

While in Service Mode, the EPB Warning Light will flash continuously while the ignition is in ON/RUN.

When brake service work is complete, the following steps must be followed to reset the park brake system to normal operation:

- Ensure the vehicle is at a standstill.
- Press the brake pedal with moderate force.
- Apply the EPB Switch.

WARNING!

You can be badly injured working on or around a motor vehicle. Do only that service work for which you have the knowledge and the right equipment. If you have any doubt about your ability to perform a service job, take your vehicle to a competent mechanic.

AUTOMATIC TRANSMISSION

You must press and hold the brake pedal while shifting out of PARK.

WARNING!

- Never use the PARK position as a substitute for the parking brake. Always apply the parking brake fully when exiting the vehicle to guard against vehicle movement and possible injury or damage.
- Your vehicle could move and injure you and others if it is not in PARK. Check by trying to move the transmission gear selector out of PARK with the brake pedal released. Make sure the transmission is in PARK before exiting the vehicle.
- The transmission may not engage PARK if the vehicle is moving. Always bring the vehicle to a complete stop before shifting to PARK, and verify that the transmission gear position indicator solidly indicates PARK (P) without blinking. Ensure that the vehicle is completely stopped, and the PARK position is properly indicated, before exiting the vehicle.

(Continued)

WARNING!

- It is dangerous to shift out of PARK or NEUTRAL if the engine speed is higher than idle speed. If your foot is not firmly pressing the brake pedal, the vehicle could accelerate quickly forward or in reverse. You could lose control of the vehicle and hit someone or something. Only shift into gear when the engine is idling normally and your foot is firmly pressing the brake pedal.
- Unintended movement of a vehicle could injure those in or near the vehicle. As with all vehicles, you should never exit a vehicle while the engine is running. Before exiting a vehicle, always come to a complete stop, then apply the parking brake, shift the transmission into PARK, and turn the ignition OFF. When the ignition is in the OFF position, the transmission is locked in PARK, securing the vehicle against unwanted movement.
- When exiting the vehicle, always make sure the ignition is in the OFF position, remove the key fob from the vehicle, and lock the vehicle.
- Never leave children alone in a vehicle, or with access to an unlocked vehicle. Allowing children to be in a vehicle unattended is dangerous for a number of reasons. A child or others could be seriously or fatally injured. Children should be warned not to touch the parking brake, brake pedal or the transmission gear selector.
- Do not leave the key fob in or near the vehicle (or in a location accessible to children), and do not leave the ignition in the ON/RUN position. A child could operate power windows, other controls, or move the vehicle.

CAUTION!

Damage to the transmission may occur if the following precautions are not observed:

- Shift into or out of PARK or REVERSE only after the vehicle has come to a complete stop.
- Do not shift between PARK, REVERSE, NEUTRAL, or DRIVE when the engine is above idle speed.
- Before shifting into any gear, make sure your foot is firmly pressing the brake pedal.

IGNITION PARK INTERLOCK

This vehicle is equipped with an Ignition Park Interlock which requires the transmission to be in PARK (P) before the ignition can be turned to the OFF position. This helps the driver avoid inadvertently leaving the vehicle without placing the transmission in PARK. This system also locks the transmission in PARK whenever the ignition is in the OFF position.

NOTE:

The transmission will NOT shift out of the PARK position if the engine is not running even when the brakes are applied. Ensure that the transmission is in PARK, and the ignition is **OFF** (not in ACC position) before exiting the vehicle.

BRAKE/TRANSMISSION SHIFT INTERLOCK (BTSI) SYSTEM

This vehicle is equipped with a BTSI system that holds the transmission gear selector in PARK unless the brakes are applied. To shift the transmission out of

PARK, the engine must be running and the brake pedal must be pressed.

The brake pedal must also be pressed to shift from NEUTRAL into DRIVE or REVERSE when the vehicle is stopped or moving at low speeds.

8-SPEED AUTOMATIC TRANSMISSION

Rotary Shifter

The transmission is controlled using a rotary electronic gear selector located on the instrument panel. The transmission gear range (PRND) is displayed both above the gear selector and in the instrument cluster. To select a gear range, simply rotate the gear selector. You must press the brake pedal to shift the transmission out of PARK (or NEUTRAL, when the vehicle is stopped or moving at low speeds). To shift past multiple gear ranges at once (such as PARK to DRIVE), simply rotate the gear selector to the appropriate detent. Select the DRIVE range for normal driving.

NOTE:

In the event of a mismatch between the gear selector position and the actual transmission gear (for example, driver selects PARK while driving), the position indicator will blink continuously until the selector is returned to the proper position, or the requested shift can be completed.

The electronically controlled transmission adapts its shift schedule based on driver inputs, along with environmental and road conditions. The transmission electronics are self-calibrating; therefore, the first few shifts on a new vehicle may be somewhat abrupt. This

is a normal condition, and precision shifts will develop within a few hundred miles (kilometers).

Only shift from DRIVE to PARK or REVERSE when the accelerator pedal is released and the vehicle is stopped. Be sure to keep your foot on the brake pedal when shifting between these gears.

The transmission gear selector has only PARK, REVERSE, NEUTRAL, and DRIVE positions. Manual downshifts can be made using the Electronic Range Select (ERS) shift control. Pushing the GEAR “-”/GEAR “+” switches (on the steering wheel) while in the DRIVE position will select the highest available transmission gear, and will display that gear limit in the instrument cluster as 1, 2, 3, etc. Some models will display both the selected gear limit, and the actual current gear, while in ERS mode.

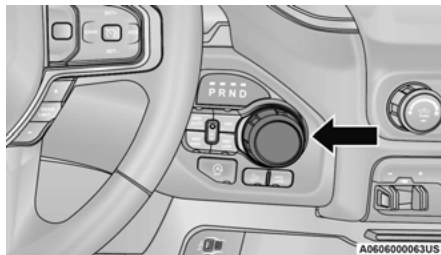

Electronic Transmission Gear Selector

Gear Ranges

Do not press the accelerator pedal when shifting from PARK or NEUTRAL into another gear range.

NOTE:

After selecting any gear range, wait a moment to allow the selected gear to engage before accelerating. This is especially important when the engine is cold.

PARK (P)

This range supplements the parking brake by locking the transmission. The engine can be started in this range. Never attempt to use PARK while the vehicle is in motion. Apply the parking brake when exiting the vehicle in this range.

When parking on a hill, apply the parking brake before shifting the transmission to PARK. As an added precaution, turn the front wheels toward the curb on a downhill grade and away from the curb on an uphill grade.

NOTE:

On four-wheel drive vehicles be sure that the transfer case is in a drive position.

When exiting the vehicle, always:

- Apply the parking brake.
- Shift the transmission into PARK.
- Turn the engine off.
- Remove the key fob from the vehicle.

CAUTION!

- DO NOT race the engine when shifting from PARK or NEUTRAL into another gear range, as this can damage the drivetrain.

(Continued)

CAUTION!

- Before moving the transmission gear selector out of PARK, you must start the engine, and also press the brake pedal. Otherwise, damage to the gear selector could result.

The following indicators should be used to ensure that you have properly engaged the transmission into the PARK position:

- When shifting into PARK, push the lock button on the gear selector and firmly move the selector all the way forward until it stops and is fully seated.
- Look at the transmission gear position display and verify that it indicates the PARK position (P), and is not blinking.
- With the brake pedal released, verify that the gear selector will not move out of PARK.

REVERSE (R)

This range is for moving the vehicle backward. Shift into REVERSE only after the vehicle has come to a complete stop.

NEUTRAL (N)

Use this range when the vehicle is standing for prolonged periods with the engine running. Apply the parking brake and shift the transmission into PARK if you must exit the vehicle.

WARNING!

Do not coast in NEUTRAL and never turn off the ignition to coast down a hill. These are unsafe practices that limit your response to changing traffic or road conditions. You might lose control of the vehicle and have a collision.

CAUTION!

Towing the vehicle, coasting, or driving for any other reason with the transmission in NEUTRAL can cause severe transmission damage.

For Recreational Towing ⇨ page 218.

For Towing A Disabled Vehicle ⇨ page 346.

DRIVE (D)

This range should be used for most city and highway driving. It provides the smoothest upshifts and downshifts, and the best fuel economy. The transmission automatically upshifts through all forward gears.

When frequent transmission shifting occurs (such as when operating the vehicle under heavy loading conditions, in hilly terrain, traveling into strong head winds, or while towing a heavy trailer), select TOW/HAUL mode or use the Electronic Range Select (ERS) shift control to select a lower gear range ⇨ page 146. Under these conditions, using a lower gear range will improve performance and extend transmission life by reducing excessive shifting and heat buildup.

During extremely cold temperatures (-22 °F [-30 °C] or below), transmission operation may be modified

depending on engine and transmission temperature as well as vehicle speed. Normal operation will resume once the transmission temperature has risen to a suitable level.

SPORT (S)

The SPORT (S, +/-) position (beside the DRIVE position) enables full manual control of transmission shifting (also known as AutoStick mode. Toggling the gear selector forward (-) or rearward (+) while in the SPORT (AutoStick) position will manually select the transmission gear, and will display the current gear in the instrument cluster.

Transmission Limp Home Mode

Transmission function is monitored electronically for abnormal conditions. If a condition is detected that could result in transmission damage, Transmission Limp Home Mode is activated. In this mode, the transmission may operate only in certain gears, or may not shift at all. Vehicle performance may be severely degraded and the engine may stall. In some situations, the transmission may not re-engage if the engine is turned off and restarted. The Malfunction Indicator Light (MIL) may be illuminated. A message in the instrument cluster will inform the driver of the more serious conditions, and indicate what actions may be necessary.

In the event of a momentary problem, the transmission can be reset to regain all forward gears by performing the following steps:

NOTE:

In cases where the instrument cluster message indicates the transmission may not re-engage after

engine shutdown, perform this procedure only in a desired location (preferably, at an authorized dealer).

1. Stop the vehicle.
2. Shift the transmission into PARK, if possible. If not, shift the transmission to NEUTRAL.
3. Push and hold the ignition switch until the engine turns off.
4. Wait approximately 30 seconds.
5. Restart the engine.
6. Shift into the desired gear range. If the problem is no longer detected, the transmission will return to normal operation.

NOTE:

Even if the transmission can be reset, we recommend that you visit an authorized dealer at your earliest possible convenience. An authorized dealer has diagnostic equipment to assess the condition of your transmission. If the transmission cannot be reset, an authorized dealer service is required.

Electronic Range Select (ERS) Operation — If Equipped

The ERS shift control allows the driver to limit the highest available gear when the transmission is in DRIVE and ERS mode is not active. For example, if you set the transmission gear limit to FOURTH gear, the transmission will hold that gear and not shift above FOURTH gear, but will shift through the lower gears normally.

NOTE:

ERS will only upshift during a FIRST to SECOND gear shift when in 4WD LOW. All other ranges will hold the gear.

You can switch between DRIVE and ERS mode at any vehicle speed. When the transmission gear selector is in DRIVE, the transmission will operate automatically, shifting between all available gears. Tapping the “-” button (on the steering wheel) will activate ERS mode, display the current gear in the instrument cluster, and set that gear as the top available gear. Once in ERS mode, tapping the “-” or “+” button will change the top available gear.

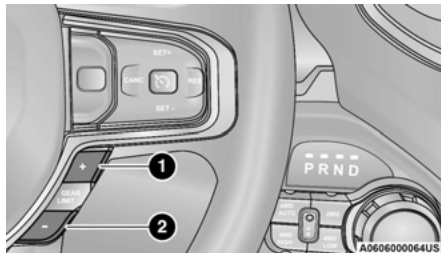

Electronic Range Select (ERS)

- 1 — Shift Up “+”
- 2 — Shift Down “-”

To exit ERS mode, simply push and hold the “+” button until the gear limit display disappears from the instrument cluster.

WARNING!

Do not downshift for additional engine braking on a slippery surface. The drive wheels could lose their grip and the vehicle could skid, causing a collision or personal injury.

When to Use TOW/HAUL Mode

Select TOW/HAUL mode when driving in conditions such as: driving in hilly areas, towing a trailer, carrying a heavy load, etc. This mode will improve performance and reduce the potential for transmission overheating or failure due to excessive shifting.

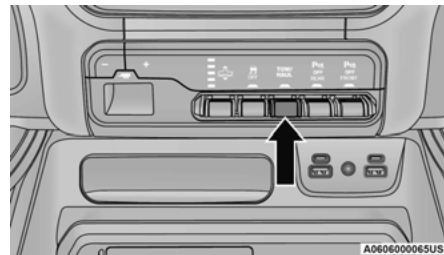

TOW/HAUL Switch

The TOW/HAUL Indicator Light will illuminate in the instrument cluster to indicate that TOW/HAUL mode has been activated. Pushing the switch a second time restores normal operation. Normal operation is always the default at engine start-up. If TOW/HAUL mode is desired, the switch must be pushed each time the engine is started.

WARNING!

Do not use the TOW/HAUL feature when driving in icy or slippery conditions. The increased engine braking can cause the rear wheels to slide, and the vehicle to swing around with the possible loss of vehicle control, which may cause an accident possibly resulting in personal injury or death.

FOUR-WHEEL DRIVE OPERATION — IF EQUIPPED

FOUR-POSITION ELECTRONICALLY SHIFTED TRANSFER CASE — IF EQUIPPED

This is an electronic shift transfer case and is operated by the 4WD Control Switch (Transfer Case Switch), located on the instrument panel.

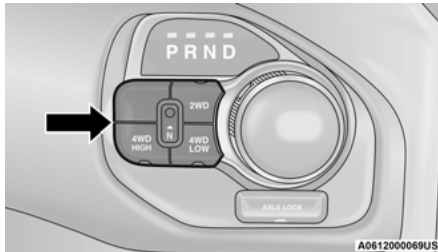

Four-Position/On-Demand Transfer Case

This electronically shifted transfer case provides four positions:

- Two-Wheel Drive High Range (2WD) — This range is for normal street and highway driving on dry hard surfaced roads. Driving the vehicle in 2WD will have greater fuel economy benefits as the front axle is not engaged in 2WD.
- Four-Wheel Drive High Range (4WD HIGH) — This range provides torque to the front driveshaft (engages four-wheel drive) which allows front and rear wheels to spin at the same speed. This provides additional traction for loose or slippery road surfaces only.
- Four-Wheel Drive Low Range (4WD LOW) — This range provides low speed four-wheel drive. It maximizes torque (increased torque over 4WD HIGH) to the front driveshaft; allowing front and rear wheels to rotate at the same speed. This range provides additional traction and maximum pulling power for loose or slippery road surfaces only. Do not exceed 25 mph (40 km/h) in this range.
- N (Neutral) — This range disengages both the front and rear driveshafts from the powertrain. To be used for flat towing behind another vehicle ⇨ page 218.

WARNING!

- You or others could be injured or killed if you leave the vehicle unattended with the transfer case in the N (Neutral) position without first fully engaging the parking brake. The transfer case N (Neutral) position disengages both the front and

(Continued)

WARNING!

rear drive shaft from the powertrain, and will allow the vehicle to roll, even if the transmission is in PARK. The parking brake should always be applied when the driver is not in the vehicle.

- The transmission may not engage PARK if the vehicle is moving. Always bring the vehicle to a complete stop before shifting to PARK, and verify that the transmission gear position indicator solidly indicates PARK (P) without blinking. Ensure that the vehicle is completely stopped, and the PARK position is properly indicated, before exiting the vehicle.

NOTE:

- The 4WD HIGH and 4WD LOW positions are designed for loose, slippery road surfaces only. Driving in the 4WD HIGH and 4WD LOW positions on dry, hard surfaced roads may cause increased tire wear and damage to the driveline components.
- The transfer case N (Neutral) button is located in the center of the 4WD Control Switch and is pushed by using a ballpoint pen or similar object. The transfer case N (Neutral) position is to be used for recreational towing only ⇨ page 218.

Transfer Case Position Indicator Lights

The Transfer Case Position Indicator Lights (4WD HIGH and 4WD LOW) are located in the instrument cluster and indicate the current and desired transfer case selection. When you select a different transfer case position, the indicator lights will do the following:

1. The current position indicator light will turn off.

- The selected position indicator light will flash until the transfer case completes the shift.
- When the shift is complete, the indicator light for the selected position will stop flashing and remain on.

If the transfer case does not shift into the desired position, one or more of the following events may occur:

- The indicator light for the current position will remain on.
- The newly selected position indicator light will continue to flash.
- If the transfer case **will not** shift, a message will appear on the cluster stating the 4WD shift has canceled.

NOTE:

Before retrying a selection, make certain that all the necessary requirements for selecting a new transfer case position have been met. To retry the selection, push the current position, wait five seconds, and retry selection.

The SERV 4WD Warning Light monitors the electronic shift four-wheel drive system. If this light remains on after engine start-up or illuminates during driving, it means that the four-wheel drive system is not functioning properly and that service is required.

WARNING!

Always engage the parking brake when powering down the vehicle if the SERV 4WD Warning Light is illuminated. Not engaging the parking brake may

(Continued)

WARNING!

allow the vehicle to roll which may cause personal injury or death.

NOTE:

Do not attempt to make a shift while only the front or rear wheels are spinning. This could cause damage to driveline components.

When operating your vehicle in 4WD LOW, the engine speed is approximately three times that of the 2WD or 4WD HIGH positions at a given road speed. Take care not to overspeed the engine and do not exceed 25 mph (40 km/h).

Proper operation of four-wheel drive vehicles depends on tires of equal size, type and circumference on each wheel. Any difference in tire size can cause damage to the drivetrain.

Because four-wheel drive provides improved traction, there is a tendency to exceed safe turning and stopping speeds. Do not go faster than road conditions permit.

Shifting Procedure

- If any of the requirements to select a new transfer case position have not been met, then the transfer case will not shift. The position indicator light for the previous position will remain on and the newly selected position indicator light will continue to flash until all the requirements for the selected position have been met.
- If all the requirements to select a new transfer case position have been met, then the current position indicator light will turn off and the selected position indicator light will flash until the transfer

case completes the shift. When the shift is complete, the position indicator light for the selected position will stop flashing and remain on.

2WD TO 4WD HIGH

Push the desired position on the four-wheel drive control switch to shift the transfer case. Shifts between 2WD and 4WD HIGH can be done with the vehicle stopped or in motion. With the vehicle in motion, the transfer case will engage/disengage faster if you momentarily release the accelerator pedal after turning the control switch. If the vehicle is stopped, the ignition switch must be in the ON/RUN position with the engine either running or off.

NOTE:

The four-wheel drive system will not allow shifts between 2WD/4WD HIGH if the front and/or rear wheels are spinning (no traction). In this situation, the selected position indicator light will flash and the original position indicator light will remain on. At this time, reduce speed and stop spinning the wheels to complete the shift.

2WD OR 4WD HIGH TO 4WD LOW

NOTE:

When shifting into or out of 4WD LOW some gear noise may be heard. This noise is normal and is not detrimental to the vehicle or occupants.

Shifting can be performed with the vehicle rolling 2 to 3 mph (3 to 5 km/h) or completely stopped. You can use either of the following procedures:

Preferred Procedure

1. With the engine running, slow the vehicle to 2 to 3 mph (3 to 5 km/h).
2. Shift the transmission into NEUTRAL.
3. While still rolling, push the desired position on the transfer case control switch.
4. After the desired position indicator light is on (not flashing), shift the transmission back into gear.

Alternate Procedure

1. Bring the vehicle to a complete stop.
2. With the ignition switch in the ON/RUN position and the engine running, shift the transmission into NEUTRAL.
3. Push the desired position on the transfer case control switch.
4. After the desired position indicator light is on (not flashing), shift the transmission back into gear.

NOTE:

- If Steps 1 or 2 of either the Preferred or Alternate Procedure are not satisfied prior to attempting the shift, then the desired position indicator light will flash continuously while the original position indicator light is on, until all requirements have been met.
- The ignition switch must be in the ON/RUN position for a shift to take place and for the position indicator lights to be operable. If the ignition switch is not in

the ON/RUN position, the shift will not take place and no position indicator lights will be on or flashing.

FIVE-POSITION ELECTRONICALLY SHIFTED TRANSFER CASE — IF EQUIPPED

This is an electronic shift transfer case and is operated by the 4WD Control Switch (Transfer Case Switch), which is located on the instrument panel.

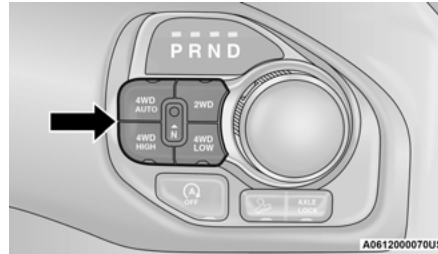

Five-Position/On-Demand Transfer Case

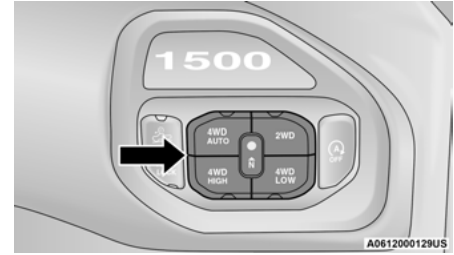

Five-Position/On-Demand Transfer Case — GT Models

This electronically shifted transfer case provides five positions:

- Two-Wheel Drive High Range (2WD) — This range is for normal street and highway driving on dry hard surfaced roads. Driving the vehicle in 2WD will have greater fuel economy benefits as the front axle is not engaged in 2WD.
- Four-Wheel Drive Automatic High Range (4WD AUTO) — This range sends power to the front wheels automatically when the vehicle senses a loss of traction. This range may be used during varying road conditions.
- Four-Wheel Drive High Range (4WD HIGH) — This range provides torque to the front driveshaft (engages four-wheel drive) which allows front and rear wheels to spin at the same speed. This provides additional traction for loose or slippery road surfaces only.

- Four-Wheel Drive Low Range (4WD LOW) — This range provides low speed four-wheel drive. It maximizes torque (increased torque over 4WD HIGH) to the front driveshaft; allowing front and rear wheels to rotate at the same speed. This range provides additional traction and maximum pulling power for loose or slippery road surfaces only. Do not exceed 25 mph (40 km/h) in this range.
- N (Neutral) — This range disengages both the front and rear driveshafts from the powertrain. To be used for flat towing behind another vehicle ⇨ page 218.

WARNING!

- You or others could be injured or killed if you leave the vehicle unattended with the transfer case in the N (Neutral) position without first fully engaging the parking brake. The transfer case N (Neutral) position disengages both the front and rear drive shaft from the powertrain, and will allow the vehicle to roll, even if the transmission is in PARK. The parking brake should always be applied when the driver is not in the vehicle.
- The transmission may not engage PARK if the vehicle is moving. Always bring the vehicle to a complete stop before shifting to PARK, and verify that the transmission gear position indicator solidly indicates PARK (P) without blinking. Ensure that the vehicle is completely stopped, and the PARK position is properly indicated, before exiting the vehicle.

NOTE:

- The 4WD HIGH and 4WD LOW positions are designed for loose, slippery road surfaces only.

Driving in the 4WD HIGH and 4WD LOW positions on dry hard surfaced roads may cause increased tire wear and damage to the driveline components.

- The transfer case N (Neutral) button is located in the center of the 4WD Control Switch and is pushed by using a ballpoint pen or similar object. The transfer case N (Neutral) position is to be used for recreational towing only ⇨ page 218.

Transfer Case Position Indicator Lights

The Transfer Case Position Indicator Lights (4WD HIGH, 4WD LOW, and 4WD AUTO) are located in the instrument cluster and indicate the current and desired transfer case selection. When you select a different transfer case position, the indicator lights will do the following:

1. The current position indicator light will turn off.
2. The selected position indicator light will flash until the transfer case completes the shift.
3. When the shift is complete, the indicator light for the selected position will stop flashing and remain on.

If the transfer case does not shift into the desired position, one or more of the following events may occur:

1. The indicator light for the current position will remain on.
2. The newly selected position indicator light will continue to flash.
3. If the transfer case **will not** shift, there will be a cluster message stating the 4WD shift has canceled.

NOTE:

Before retrying a selection, make certain that all the necessary requirements for selecting a new transfer case position have been met. To retry the selection, push the current position, wait five seconds, and retry selection.

The SERV 4WD Warning Light monitors the electronic shift four-wheel drive system. If this light remains on after engine start-up or illuminates during driving, it means that the four-wheel drive system is not functioning properly and that service is required.

WARNING!

Always engage the parking brake when powering down the vehicle if the SERV 4WD Warning Light is illuminated. Not engaging the parking brake may allow the vehicle to roll which may cause personal injury or death.

NOTE:

Do not attempt to make a shift while only the front or rear wheels are spinning. This could cause damage to driveline components.

When operating your vehicle in 4WD LOW, the engine speed is approximately three times that of the 2WD, 4WD AUTO or 4WD HIGH positions at a given road speed. Take care not to overspeed the engine and do not exceed 25 mph (40 km/h).

Proper operation of four-wheel drive vehicles depends on tires of equal size, type and circumference on each wheel. Any difference in tire size can cause damage to the drivetrain.

Because four-wheel drive provides improved traction, there is a tendency to exceed safe turning and stopping speeds. Do not go faster than road conditions permit.

Shifting Procedure

- If any of the requirements to select a new transfer case position have not been met, then the transfer case will not shift. The position indicator light for the previous position will remain on and the newly selected position indicator light will continue to flash until all the requirements for the selected position have been met.
- If all the requirements to select a new transfer case position have been met, then the current position indicator light will turn off and the selected position indicator light will flash until the transfer case completes the shift. When the shift is complete, the position indicator light for the selected position will stop flashing and remain on.

2WD TO 4WD AUTO OR 4WD LOCK

Push the desired position on the four-wheel drive control switch to shift the transfer case. Shifts between two-wheel drive and 4WD AUTO and 4WD LOCK can be done with the vehicle stopped or in motion. With the vehicle in motion, the transfer case will engage/disengage faster if you momentarily release the accelerator pedal after turning the control switch. If the vehicle is stopped, the ignition switch must be in the ON/RUN position with the engine either running or off.

NOTE:

The four-wheel drive system will not allow shifts between 2WD and 4WD AUTO/4WD LOCK if the front

and/or rear wheels are spinning (no traction). In this situation, the selected position indicator light will flash and the original position indicator light will remain on. At this time, reduce speed and stop spinning the wheels to complete the shift.

2WD OR 4WD AUTO OR 4WD LOCK TO 4WD LOW

NOTE:

When shifting into or out of 4WD LOW some gear noise may be heard. This noise is normal and is not detrimental to the vehicle or occupants.

Shifting can be performed with the vehicle rolling 2 to 3 mph (3 to 5 km/h) or completely stopped. You can use either of the following procedures:

Preferred Procedure

1. With the engine running, slow the vehicle to 2 to 3 mph (3 to 5 km/h).
2. Shift the transmission into NEUTRAL.
3. While still rolling, push the desired position on the transfer case control switch.
4. After the desired position indicator light is on (not flashing), shift the transmission back into gear.

Alternate Procedure

1. Bring the vehicle to a complete stop.
2. With the ignition switch in the ON/RUN position and the engine running, shift the transmission into NEUTRAL.
3. Push the desired position on the transfer case control switch.

4. After the desired position indicator light is on (not flashing), shift the transmission back into gear.

NOTE:

- If Steps 1 or 2 of either the Preferred or Alternate Procedure are not satisfied prior to attempting the shift, then the desired position indicator light will flash continuously while the original position indicator light is on, until all requirements have been met.
- The ignition switch must be in the ON/RUN position for a shift to take place and for the position indicator lights to be operable. If the ignition switch is not in the ON/RUN position, the shift will not take place and no position indicator lights will be on or flashing.

4

FOUR-WHEEL DRIVE OPERATION — RHO

FOUR-POSITION ELECTRONICALLY SHIFTED TRANSFER CASE

This is an electronic shift transfer case and is operated by the 4WD Control Switch (Transfer Case Switch), which is located on the instrument panel.

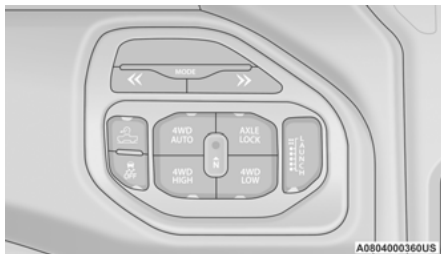

Four-Position/On-Demand Transfer Case

This electronically shifted transfer case provides four positions:

- Four-Wheel Drive Automatic High Range (4WD AUTO)
- Four-Wheel Drive High Range (4WD HIGH)
- Four-Wheel Drive Low Range (4WD LOW)
- N (Neutral)

For additional information on the appropriate use of each transfer case position, see the following:

4WD AUTO

Four-Wheel Drive Auto High Range — This range always sends power to the front wheels and automatically adjusts the front and rear torque split to optimize performance for the operating conditions. For example, when the vehicle senses a loss of traction. This range may be used during varying road conditions.

4WD HIGH

Four-Wheel Drive High Range — This range provides torque to the front driveshaft (engages four-wheel drive)

which allows front and rear wheels to spin at the same speed. This provides additional traction for loose or slippery road surfaces only. The use of 4WD HIGH on dry paved surfaces will increase tire wear and may cause damage to driveline components.

4WD LOW

Four-Wheel Drive Low Range — This range provides low-speed four-wheel drive. It maximizes torque (increased torque over 4WD HIGH) to the driveline; allowing front and rear wheels to rotate at the same speed. This range provides additional traction and maximum pulling power for loose or slippery road surfaces only. Do not exceed 55 mph (88 km/h) in this range. The use of 4WD LOW on dry paved surfaces will increase tire wear and may cause damage to driveline components.

N (Neutral)

N (Neutral) — This range disengages both the front and rear driveshafts from the powertrain. To be used for flat towing behind another vehicle.

WARNING!

- You or others could be injured or killed if you leave the vehicle unattended with the transfer case in the N (Neutral) position without first fully engaging the parking brake. The transfer case N (Neutral) position disengages both the front and rear drive shaft from the powertrain, and will allow the vehicle to roll, even if the transmission is in PARK. The parking brake should always be applied when the driver is not in the vehicle.

(Continued)

WARNING!

- The transmission may not engage PARK if the vehicle is moving. Always bring the vehicle to a complete stop before shifting to PARK, and verify that the transmission gear position indicator solidly indicates PARK (P) without blinking. Ensure that the vehicle is completely stopped, and the PARK position is properly indicated, before exiting the vehicle.

This electronically shifted transfer case is designed to be driven in the four-wheel drive auto position (4WD AUTO) for normal street and highway conditions on dry, hard surfaced roads.

When additional traction is required, the transfer case 4WD HIGH and 4WD LOW positions can be used to maximize torque to the front driveshaft, forcing the front and rear wheels to rotate at the same speed. This is accomplished pushing the desired position on the 4WD Control Switch.

For specific shifting instructions ⇨ page 148.

The 4WD HIGH and 4WD LOW positions are designed for loose, slippery road surfaces only. Driving in the 4WD HIGH and 4WD LOW positions on dry, hard surfaced roads may cause increased tire wear and damage to the driveline components.

NOTE:

The transfer case N (Neutral) button is located in the center of the 4WD Control Switch and is pushed by using a ballpoint pen or similar object. The transfer case N (Neutral) position is to be used for recreational towing only.

Transfer Case Position Indicator Lights

The Transfer Case Position Indicator Lights (4WD HIGH and 4WD LOW) are located in the instrument cluster and indicate the current and desired transfer case selection. When you select a different transfer case position, the indicator lights will do the following:

1. The current position indicator light will turn off.
2. The selected position indicator light will flash until the transfer case completes the shift.
3. When the shift is complete, the indicator light for the selected position will stop flashing and remain on.

If the transfer case does not shift into the desired position, one or more of the following events may occur:

1. The indicator light for the current position will remain on.
2. The newly selected position indicator light will continue to flash.
3. If the transfer case **will not** shift, there will be a cluster message stating the 4WD shift has canceled.

NOTE:

Before retrying a selection, make certain that all the necessary requirements for selecting a new transfer case position have been met. To retry the selection, push the current position, wait five seconds, and retry selection. To find the shift requirements ➡ page 148.

The SERV 4WD Warning Light monitors the electronic shift four-wheel drive system. If this light remains on after engine start-up or illuminates during driving,

it means that the four-wheel drive system is not functioning properly and that service is required.

WARNING!

Always engage the parking brake when powering down the vehicle if the SERV 4WD Warning Light is illuminated. Not engaging the parking brake may allow the vehicle to roll which may cause personal injury or death.

NOTE:

Do not attempt to make a shift while only the front or rear wheels are spinning. This could cause damage to driveline components.

When operating your vehicle in 4WD LOW, the engine speed is approximately three times that of the 4WD AUTO or 4WD HIGH positions at a given road speed. Take care not to overspeed the engine and do not exceed 55 mph (88 km/h).

Proper operation of four-wheel drive vehicles depends on tires of equal size, type and circumference on each wheel. Any difference in tire size can cause damage to the drivetrain.

Because four-wheel drive provides improved traction, there is a tendency to exceed safe turning and stopping speeds. Do not go faster than road conditions permit.

Shifting Procedure

- If any of the requirements to select a new transfer case position have not been met, then the transfer case will not shift. The position indicator light for the previous position will remain on and the newly selected position indicator light will continue to flash

until all the requirements for the selected position have been met.

- If all the requirements to select a new transfer case position have been met, then the current position indicator light will turn off and the selected position indicator light will flash until the transfer case completes the shift. When the shift is complete, the position indicator light for the selected position will stop flashing and remain on.

2WD TO 4WD HIGH

Push the desired position on the four-wheel drive control switch to shift the transfer case. Shifts between 2WD and 4WD HIGH can be done with the vehicle stopped or in motion. With the vehicle in motion, the transfer case will engage/disengage faster if you momentarily release the accelerator pedal after turning the control switch. If the vehicle is stopped, the ignition switch must be in the ON/RUN position with the engine either running or off.

NOTE:

The four-wheel drive system will not allow shifts between 2WD/4WD HIGH if the front and/or rear wheels are spinning (no traction). In this situation, the selected position indicator light will flash and the original position indicator light will remain on. At this time, reduce speed and stop spinning the wheels to complete the shift.

2WD OR 4WD HIGH TO 4WD LOW

NOTE:

When shifting into or out of 4WD LOW some gear noise may be heard. This noise is normal and is not detrimental to the vehicle or occupants.

Shifting can be performed with the vehicle rolling 2 to 3 mph (3 to 5 km/h) or completely stopped. You can use either of the following procedures:

Preferred Procedure

1. With the engine running, slow the vehicle to 2 to 3 mph (3 to 5 km/h).
2. Shift the transmission into NEUTRAL.
3. While still rolling, push the desired position on the transfer case control switch.
4. After the desired position indicator light is on (not flashing), shift the transmission back into gear.

Alternate Procedure

1. Bring the vehicle to a complete stop.
2. With the ignition switch in the ON/RUN position and the engine running, shift the transmission into NEUTRAL.
3. Push the desired position on the transfer case control switch.
4. After the desired position indicator light is on (not flashing), shift the transmission back into gear.

NOTE:

- If Steps 1 or 2 of either the Preferred or Alternate Procedure are not satisfied prior to attempting the shift, then the desired position indicator light will flash continuously while the original position indicator light is on, until all requirements have been met.
- The ignition switch must be in the ON/RUN position for a shift to take place and for the position indicator lights to be operable. If the ignition switch is not in

the ON/RUN position, the shift will not take place and no position indicator lights will be on or flashing.

SELEC-SPEED CONTROL (SSC)

SSC is intended for off-road driving in 4WD LOW only. SSC maintains vehicle speed by actively controlling engine torque and brakes.

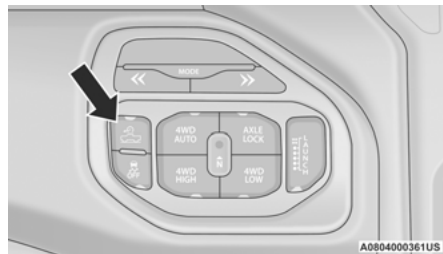

Selec-Speed Control Button

SSC has three states:

1. Off (feature is not enabled and will not activate)
2. Enabled (feature is enabled and ready but activation conditions are not met, or driver is actively overriding with brake or throttle application)
3. Active (feature is enabled and actively controlling vehicle speed)

Enabling SSC

SSC is enabled by pushing the SSC button when the following conditions are met:

- The driveline is in 4WD LOW.
- The vehicle speed is below 5 mph (8 km/h).
- The parking brake is released.
- The driver door is closed.
- The driver is not applying throttle.

Activating SSC

Once SSC is enabled it will activate automatically once the following conditions are met:

- The driver releases the throttle.
- The driver releases the brake.
- The transmission is in any selection other than PARK.
- Your vehicle speed is below 20 mph (32 km/h).

The set speed for SSC is selectable by the driver, and can be adjusted by using the paddle shifters or the gear shift (+/-) on the steering wheel. Additionally, the SSC set speed may be reduced when climbing a grade and the level of set speed reduction depends on the magnitude of grade. The following summarizes the SSC set speeds:

SSC Target Set Speeds

- 1st = 0.6 mph (1 km/h)
- 2nd = 1.2 mph (2 km/h)
- 3rd = 1.8 mph (3 km/h)
- 4th = 2.5 mph (4 km/h)
- 5th = 3.1 mph (5 km/h)
- 6th = 3.7 mph (6 km/h)

- 7th = 4.3 mph (7 km/h)
- 8th = 5 mph (8 km/h)
- REVERSE = 0.6 mph (1 km/h)
- NEUTRAL = 1.2 mph (2 km/h)
- PARK = SSC remains enabled but not active

NOTE:

- During SSC, the (+/-) gear selector input is used for SSC target speed selection but will not affect the gear chosen by the transmission. While actively controlling SSC, the transmission will shift appropriately for the driver-selected set speed and corresponding driving conditions.
- SSC operation is influenced if one of the drive modes are active. The differences may be notable to the driver as a varying level of aggressiveness.

Driver Override

The driver may override SSC activation with throttle or brake application at any time.

Deactivating SSC

SSC will be deactivated but remain available if any of the following conditions occur:

- The driver overrides SSC set speed with throttle or brake application.
- The vehicle speed exceeds 20 mph (32 km/h) but remains below 40 mph (64 km/h).
- The vehicle is shifted into PARK.

Disabling SSC

SSC will deactivate and be disabled if any of the following conditions occur:

- The driver pushes the SSC button.
- The driveline is shifted out of the 4WD LOW.
- The parking brake is applied.
- The driver door opens.
- The vehicle is driven greater than 20 mph (32 km/h) for greater than 70 seconds.
- The vehicle is driven greater than 40 mph (64 km/h). SSC will exist immediately.

Feedback To The Driver

The instrument cluster has an SSC icon and the SSC switch has a lamp which offers feedback to the driver about the state SSC is in.

- The cluster icon and switch lamp will illuminate and remain on solid when SSC is enabled or activated. These are the normal operating conditions for SSC.
- The cluster icon and switch lamp will flash for several seconds then extinguish when the driver pushes the SSC switch but enabled conditions are not met.
- The cluster icon and switch lamp will flash for several seconds then extinguish when SSC disables due to excess speed.
- The cluster icon and switch lamp will flash then extinguish when SSC deactivates due to overheated brakes.

WARNING!

SSC is only intended to assist the driver in controlling vehicle speed when driving in off-road conditions. The driver must remain attentive to the driving conditions and is responsible for maintaining a safe vehicle speed.

RHO MODES

Description

RHO modes combine the capabilities of the vehicle control systems, along with driver input, to provide the best performance for all terrains.

Use the RHO button and selection arrows to select the desired mode.

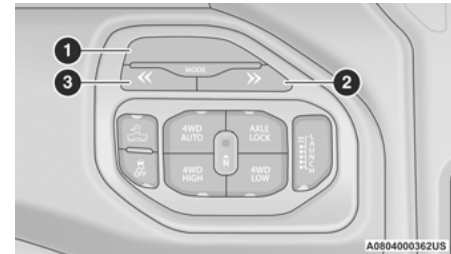

RHO Button

- 1 — RHO Button
- 2 — Right Arrow
- 3 — Left Arrow

RHO modes consist of the following positions:

- **AUTO** – This mode is intended for typical on-road driving with default settings.
- **SNOW** – This mode maximizes traction and stability with equal torque split between the front and rear wheels. The transmission defaults to early shifting and engine throttle response is softened to reduce wheel slip. SNOW mode is only meant to assist and is not a replacement for safe driving practices during inclement weather. This feature will reset to AUTO upon an ignition cycle if not in 4WD LOW.
- **TOW** – This mode minimizes transmission gear changes and adapts the suspension for towing or hauling heavy loads. Drive torque is more evenly split between the front and rear wheels for improved traction. This feature will reset to AUTO upon an ignition cycle if not in 4WD LOW.
- **SPORT** – This mode improves handling capability through front and rear torque split and increased suspension control. The transmission delivers quicker, firmer shifts. Steering force is increased for improved feedback and control. This feature will reset to AUTO on an ignition cycle. SPORT mode is not available while in 4WD LOW.
- **CUSTOM** – This mode allows the driver to create a custom vehicle configuration that is saved for quick selection of favorite settings. The system will return to AUTO mode when the ignition switch is cycled from RUN to OFF to RUN, if this mode is selected. While in CUSTOM mode the Stability, Transmission, Steering, Suspension, and paddle shifter settings may be configured through the custom mode set-up. This feature will reset to AUTO on an ignition cycle if not in 4WD LOW.

- **MUD/SAND** – This mode maximizes traction with equal torque split front and rear. Traction control intervention is reduced to allow for peak performance on mud or sand. This feature will reset to AUTO on an ignition cycle if not in 4WD LOW.
- **ROCK** – This mode maximizes rock crawling competency by increasing torque at the wheels by using 4WD LOW mode. Steering and throttle are tuned for low speed driving. This mode can only be used at speeds below 55 mph (88 km/h).
- **BAJA** – This mode provides ideal transmission shifting to keep the engine in power band for best performance. Driveline, steering, and suspension actively adjust for optimal vehicle dynamic behavior on varying terrain. This feature will reset to AUTO on an ignition cycle. BAJA mode is not available while in 4WD LOW.

Adaptive Damping System

This vehicle is equipped with an electronically controlled damping system. This system reduces body roll and pitch in many driving situations including cornering, acceleration and braking. There are three modes:

- **Street Mode** (Available in drive mode positions AUTO, SNOW and CUSTOM.) – Used during highway speeds where a touring suspension feel is desired.
- **Sport Mode** (Available in drive mode positions SPORT, TOW, AUTO and CUSTOM.) – Provides a firm suspension for better handling on-road.
- **Baja Mode** (Available in drive mode positions AUTO, CUSTOM, MUD/SAND, ROCK and BAJA.) – Optimized for high-speed off-road driving.

- **Tow Mode** Tow suspension is optimized for trailer towing stability.

Launch Control

This vehicle is equipped with a Launch Control system that is designed to allow the driver to achieve maximum vehicle acceleration in a straight line. Launch Control is a form of traction control that manages tire slip while launching the vehicle. This feature is intended for off-highway use where maximum acceleration is desired. The system is not intended to compensate for lack of driver experience or familiarity with the terrain. Use of this feature in low traction (cold, wet, gravel, etc.) conditions may result in excess wheel slip outside this system's control resulting in an aborted launch.

NOTE:

Launch Control allows you to select the best launch for vehicle, environmental, and traction conditions. When using this feature, start at a lower RPM launch setting and increment the RPM on subsequent launches until the best launch is experienced.

Preconditions:

- Launch Control should not be used on public roads. Always check surface conditions and the surrounding area.
- Launch Control is not available within the first 500 miles (805 km) of engine break-in.
- Launch Control should only be used when the engine and transmission are at operating temperature.
- Launch Control is intended to be used on dry, paved road surfaces only.

CAUTION!

Use on slippery or loose surfaces may cause damage to vehicle components and is not recommended.

- Launch Control is not available while operating in 4WD LOW.

Launch Control is only available when the following procedure is followed:

NOTE:

Pushing the RHO button on the control switch or pressing the Apps button on the touchscreen are the two options to access Launch Control features → page 262.

1. Press the Race Options button on the touchscreen.
2. Press the Launch Control button on the touchscreen. This screen will allow you to adjust your launch RPM for optimum launch/traction.
3. Push the LAUNCH button on the RHO control switch or press the Activate Launch Control button on the touchscreen; follow instructions in the instrument cluster display.

- Make sure the vehicle is not moving
- Put vehicle in FIRST gear or DRIVE
- Steering wheel must be pointing straight
- Vehicle must be on level ground
- Apply brake pressure
- While holding the brake, rapidly apply and hold the accelerator pedal to wide open throttle. The

engine speed will hold at the RPM that was set in the Launch RPM Set-up screen

NOTE:

Messages will appear in the instrument cluster display to inform the driver if one or more of the above conditions have not been met.

4. When the above conditions have been met, the instrument cluster display will read “Release Brake”.
5. Keep the vehicle pointed straight.

Launch control will be active until the vehicle reaches 62 mph (100 km/h), at which point the Electronic Stability Control (ESC) system will return to its current ESC mode as well as previous drive mode.

Launch Control will abort before launch completion and display a “Launch Aborted” message in the instrument cluster when any of the following occur:

- The accelerator pedal is released during launch.
- The ESC system detects that the vehicle is no longer moving in a straight line.
- The ESC OFF button is pushed to change the system to another mode.

CAUTION!

Do not attempt to shift when the drive wheels are spinning and do not have traction. Damage to the transmission may occur.

ACTIVE-LEVEL FOUR CORNER AIR SUSPENSION SYSTEM — IF EQUIPPED

DESCRIPTION

The air suspension system provides full-time load-leveling capability along with the benefit of being able to adjust vehicle height by using the toggle switch.

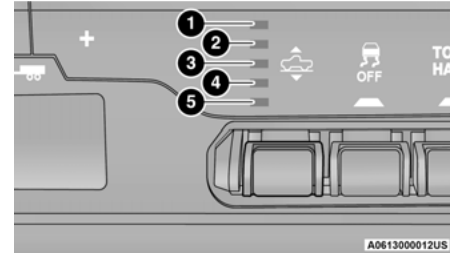

Air Suspension Switch

- 1 — Off-Road 2 Indicator (Customer Selectable)
- 2 — Off-Road 1 Indicator (Customer Selectable)
- 3 — Normal Ride Height Indicator (Customer Selectable)
- 4 — Aero Height Indicator (Customer Selectable)
- 5 — Entry/Exit Height Indicator (Customer Selectable)

- **Off-Road 2 (OR2) (Raises the vehicle approximately 2 inches [51 mm])** - This position is intended for off-road use only where maximum ground clearance is required. To enter OR2, push the height selector switch up twice from the NRH position or once from

the OR1 position while vehicle speed is below 20 mph (32 km/h). While in OR2, if the vehicle speed exceeds 25 mph (40 km/h) the vehicle height will be automatically lowered to OR1. Off-Road 2 may not be available due to vehicle payload, an instrument cluster message is displayed when this occurs ➡ page 116.

CAUTION!

If the vehicle is in Off-Road 1 or Off-Road 2 setting, be aware of your surroundings, you may not have the clearance required for certain areas and vehicle damage may occur.

- **Off-Road 1 (OR1) (Raises the vehicle approximately 1 inch [26 mm])** – This position should be the primary position for all off-road driving until Off-Road 2 (OR2) is needed. A smoother and more comfortable ride will result. To enter OR1, push the height selector switch up once from the NRH position while the vehicle speed is below 35 mph (56 km/h). When in the OR1 position, if the vehicle speed remains between 40 mph (64 km/h) and 50 mph (80 km/h) for greater than 20 seconds or if the vehicle speed exceeds 50 mph (80 km/h), the vehicle will be automatically lowered to NRH. Off-Road 1 may not be available due to vehicle payload, an instrument cluster message is displayed when this occurs ➡ page 116.
- **Normal Ride Height (NRH)** – This is the standard position of the suspension and is meant for normal driving.
- **Aero Height (Lowers the vehicle approximately 0.6 inch [15 mm])** – This position provides improved

aerodynamics by lowering the vehicle. The vehicle will automatically enter Automatic Aero Mode when the vehicle speed remains between 62 mph (100 km/h) and 66 mph (106 km/h) for greater than 20 seconds or if the vehicle speed exceeds 66 mph (106 km/h). The vehicle will return to NRH from Aero Mode if the vehicle speed remains between 30 mph (48 km/h) and 35 mph (56 km/h) for greater than 20 seconds or if the vehicle speed falls below 30 mph (48 km/h).

To enter Aero Height manually push the height selector switch down once from NRH at any vehicle speed. To return to NRH push the height selector switch up once while vehicle speed is less than 56 mph (90 km/h).

- **Entry/Exit Height (Lowers the vehicle approximately 2 inches [51 mm])** – This position lowers the vehicle for easier passenger entry and exit as well as lowering the vehicle for easier loading and unloading of cargo. To enter Entry/Exit Height Mode, push the height selector switch down twice from NRH while the vehicle speed is below 4 mph (7 km/h). If the vehicle speed exceeds 6 mph (10 km/h), the vehicle will raise to Default Ride Height (Normal or Aero).

NOTE:

Entry/Exit Height may be achieved using the Remote Lowering feature on your key fob for easier entry/loading.

CAUTION!

When in Entry/Exit Height, be aware of your surroundings, you may not have the clearance

(Continued)

CAUTION!

required for certain areas and vehicle damage may occur.

The system requires that the ignition be in the ON/RUN position or the engine running for all user requested changes. When lowering the vehicle, all of the doors must be closed. If a door is opened at any time while the vehicle is lowering, the change will not be completed until the open door(s) is closed.

This system uses a lifting and lowering pattern which keeps the headlights from incorrectly shining into oncoming traffic. When raising the vehicle, the rear of the vehicle will move up first and then the front. When lowering the vehicle, the front will move down first and then the rear.

After the engine is turned off, it may be noticed that the air suspension system operates briefly; this is normal. The system is correcting the position of the vehicle to ensure a proper appearance.

To assist with changing a spare tire, the air suspension system has a feature which allows the automatic leveling to be disabled ➡ page 116.

Default Ride Height:

- Select Aero Height or Normal Ride Height as the default for all vehicle speeds and operation. This is the selected height that the suspension will level for speed changes (e.g. raising from Entry/Exit Height at speed, lowering from Off-Road Height at speed, etc.).
- Default ride height can be changed by selecting between Normal or Aero in the radio under the Suspension settings.

NOTE:

If equipped with a touchscreen radio, all enabling/disabling of air suspension features must be done through the radio → page 227.

WARNING!

The air suspension system uses a high pressure volume of air to operate the system. To avoid personal injury or damage to the system, see an authorized dealer for service.

AIR SUSPENSION MODES

The air suspension system has multiple modes to protect the system in unique situations. The engine should be running to change between Air Suspension Modes.

Service Mode

Service Mode will disable the air suspension system at the current selected right height to assist with changing a tire, servicing the vehicle, or performing a wheel alignment. → page 227.

Protection Strategy

In order to protect the air suspension system, the vehicle will disable load leveling as required (suspension overloaded, battery charge low, etc.). Load leveling will automatically resume as soon as system operation requirements are met. See an authorized dealer if system does not resume.

NOTE:

For towing with air suspension → page 206.

INSTRUMENT CLUSTER DISPLAY MESSAGES

When the appropriate conditions exist, a message will appear in the instrument cluster display → page 116.

An audible chime will be heard whenever a system error has been detected.

See an authorized dealer for system service if normal operation does not resume.

OPERATION

The indicator lamps 1 through 5 will illuminate to show the current position of the vehicle. Flashing indicator lamps will show a position which the system is working to achieve. When raising, if multiple indicator lamps are flashing, the highest flashing indicator lamp is the position the system is working to achieve. When lowering, if multiple indicators are flashing, the lowest solid indicator lamp is the position the system is working to achieve.

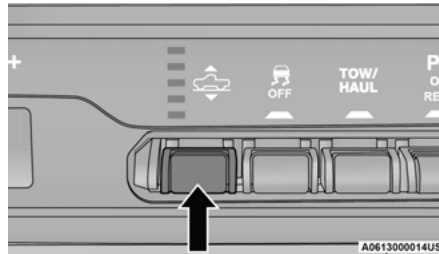

Air Suspension Switch

Pushing the height selector up once will move the suspension one position higher from the current position, assuming all conditions are met (i.e., ignition in ON/RUN position, engine running, speed below threshold, etc.). The height selector switch can be pushed up multiple times, each push will raise the requested level by one position up to a maximum position of OR2 or the highest position allowed based on current conditions (i.e., vehicle speed, etc.).

Pushing the height selector down once will move the suspension one position lower from the current level, assuming all conditions are met (i.e., ignition in ON/RUN position, engine running, doors closed, speed below threshold, etc.). The height selector switch can be pushed down multiple times, each push will lower the requested level by one position down to a minimum of Entry/Exit Mode or the lowest position allowed based on current conditions (i.e., vehicle speed, etc.).

Automatic height changes will occur based on vehicle speed and the current vehicle height. The indicator lamps and instrument cluster display messages will operate the same for automatic changes and user requested changes.

- Off-Road 2 (OR2) – Indicator lamps 5, 4, 3, 2 and 1 will be illuminated.
- Off-Road 1 (OR1) – Indicator lamps 5, 4, 3 and 2 will be illuminated.
- Normal Ride Height (NRH) – Indicator lamps 5, 4 and 3 will be illuminated.
- Aero Height – Indicator lamps 5 and 4 will be illuminated.

- Entry/Exit – Indicator lamp 5 will be illuminated. Entry/Exit can be requested up to 33 mph (53 km/h). If vehicle speed is reduced to, and kept below, 15 mph (24 km/h) indicator lamp 4 will flash and indicator lamp 5 will remain solid until Entry/Exit is achieved at which point indicator lamp 4 will turn off.
- Service Mode – Indicator lamps 5 and 1 will be illuminated. Service Mode is disabled by driving the vehicle or disabling in the Uconnect settings.

ACTIVE-LEVEL FOUR CORNER AIR SUSPENSION SYSTEM (OFF-ROAD GROUP) — IF EQUIPPED

DESCRIPTION

The air suspension system provides full-time load-leveling capability along with the benefit of being able to adjust vehicle height by using the toggle switch.

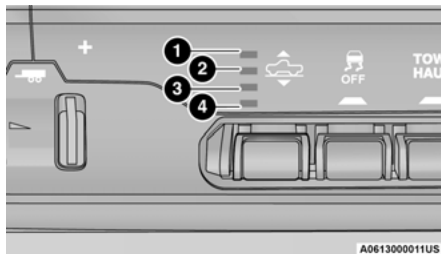

Rebel or Off-Road Package Air Suspension Controls

- 1 – Off-Road Indicator (Customer Selectable)
- 2 – Normal Ride Height Indicator (Customer Selectable)
- 3 – Aero Height Indicator (Customer Selectable)
- 4 – Entry/Exit Height Indicator (Customer Selectable)

- **Off-Road (OR) (Raises the vehicle approximately 1 inch [26 mm])** – This position is intended for off-roading use only where maximum ground clearance is required. To enter OR, push the height selector switch up once from the NRH position while vehicle speed is below 20 mph (32 km/h). While in OR, if the vehicle speed exceeds 25 mph (40 km/h) the vehicle height will be automatically lowered to NRH. Off-Road may not be available due to vehicle payload, an instrument cluster display message is shown when this occurs → page 116 .

CAUTION!

If the vehicle is in Off-Road setting, be aware of your surroundings, you may not have the clearance required for certain areas and vehicle damage may occur.

- **Normal Ride Height (NRH)** – This is the standard position of the suspension and is meant for normal driving.
- **Aero Height (Lowers the vehicle approximately 0.6 inches [15 mm])** – This position provides improved aerodynamics by lowering the vehicle. The vehicle will automatically enter Automatic Aero Mode when the vehicle speed remains between 62 mph (100 km/h) and 66 mph (106 km/h) for greater than 20 seconds or if the vehicle speed exceeds 66 mph (106 km/h). The vehicle will return to Default Ride Height from Aero Mode if the vehicle speed remains between 30 mph (48 km/h) and 35 mph (56 km/h) for greater than 20 seconds or if the vehicle speed falls below 30 mph (48 km/h).

NOTE:

- Automatic Aero mode will be disabled if a trailer is detected to prevent shifting loads.
- To enter Aero Height manually push the height selector switch down once from NRH at any vehicle speed. To return to NRH push the height selector switch up once while vehicle speed is less than 56 mph (90 km/h).
- **Entry/Exit Height (Lowers the vehicle approximately 3 inches [73 mm])** – This position lowers the vehicle for easier passenger entry and exit as well as lowering the vehicle for easier loading and unloading

of cargo. To enter Entry/Exit Height Mode, push the height selector switch down twice from NRH while the vehicle speed is below 4 mph (7 km/h). If the vehicle speed exceeds 6 mph (10 km/h), the vehicle will raise to Default Ride Height (Normal or Aero). Entry/Exit Height may not be available due to vehicle payload, an instrument cluster display message is shown when this occurs → page 116 .

CAUTION!

When in Entry/Exit Height, be aware of your surroundings, you may not have the clearance required for certain areas and vehicle damage may occur.

The system requires that the ignition be in the ON/RUN position or the engine running for all user requested changes. When lowering the vehicle, all of the doors must be closed. If a door is opened at any time while the vehicle is lowering, the change will not be completed until the open door(s) is closed.

This system uses a lifting and lowering pattern which keeps the headlights from incorrectly shining into oncoming traffic. When raising the vehicle, the rear of the vehicle will move up first and then the front. When lowering the vehicle, the front will move down first and then the rear.

After the engine is turned off, it may be noticed that the air suspension system operates briefly; this is normal. The system is correcting the position of the vehicle to ensure a proper appearance.

To assist with changing a spare tire, the air suspension system has a feature which allows the automatic leveling to be disabled → page 227.

Default Ride Height:

- Select Aero Height or Normal Ride Height as the default for all vehicle speeds and operation. This is the selected height that the suspension will level for speed changes (e.g. raising from Entry/Exit Height at speed, lowering from Off-Road Height at speed, etc.).
- Default ride height can be changed by selecting between Normal or Aero in the radio under the Suspension settings.

NOTE:

If equipped with a touchscreen radio, all enabling/disabling of air suspension features must be done through the radio → page 227.

WARNING!

The air suspension system uses a high pressure volume of air to operate the system. To avoid personal injury or damage to the system, see an authorized dealer for service.

AIR SUSPENSION MODES

The air suspension system has multiple modes to protect the system in unique situations:

Service Mode

Service Mode will disable the air suspension system at the current selected right height to assist with changing a tire, servicing the vehicle, or performing a wheel alignment. → page 227.

Protection Strategy

In order to protect the air suspension system, the vehicle will disable load leveling as required (suspension overloaded, battery charge low, etc.). Load leveling will automatically resume as soon as system operation requirements are met. See an authorized dealer if system does not resume.

NOTE:

For towing with air suspension → page 206.

INSTRUMENT CLUSTER DISPLAY MESSAGES

When the appropriate conditions exist, a message will appear in the instrument cluster display → page 116.

An audible chime will be heard whenever a system error has been detected.

See an authorized dealer for system service if normal operation does not resume.

OPERATION

The indicator lamps 1 through 4 will illuminate to show the current position of the vehicle. Flashing indicator lamps will show a position which the system is working to achieve. When raising or lowering, the flashing indicator lamp is the position the system is working to achieve.

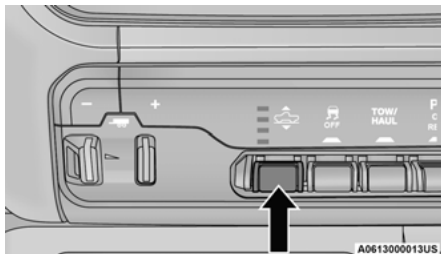

Air Suspension Switch

Pushing the height selector switch up once will move the suspension one position higher from the current position, assuming all conditions are met (i.e., key in ON/RUN position, engine running, speed below threshold, etc.). The height selector switch can be pushed up multiple times, each push will raise the requested level by one position up to a maximum position of OR or the highest position allowed based on current conditions (i.e., vehicle speed, etc.).

Pushing the height selector switch down once will move the suspension one position lower from the current level, assuming all conditions are met (i.e., key in ON/RUN position, engine running, doors closed, speed below threshold, etc.). The height selector switch can be pushed down multiple times, each push will lower the requested level by one position down to a minimum of Entry/Exit Mode or the lowest position allowed based on current conditions (i.e., vehicle speed, etc.).

Automatic height changes will occur based on vehicle speed and the current vehicle height. The indicator lamps and instrument cluster display messages will

operate the same for automatic changes and user requested changes.

- Off-Road (OR) – Indicator lamps 4, 3, 2, and 1 will be illuminated.
- Normal Ride Height (NRH) – Indicator lamps 4, 3, and 2 will be illuminated.
- Aero Height– Indicator lamps 4 and 3 will be illuminated.
- Entry/Exit – Indicator lamp 4 will be illuminated. Entry/Exit can be requested up to 33 mph (53 km/h). If vehicle speed is reduced to, and kept below, 15 mph (24 km/h) indicator lamp 3 will flash and indicator lamp 4 will remain solid until Entry/Exit is achieved at which point indicator lamp 3 will turn off.
- Automatic Aero Mode – Indicator lamps 3 and 4 will be illuminated.
- Service Mode – Indicator lamps 4 and 1 will be illuminated. Service Mode is disabled by driving the vehicle or disabling in the Uconnect settings.

ACTIVE NOISE CANCELLATION

Your vehicle is equipped with an Active Noise Cancellation system that cannot be turned off. This system is designed to address exhaust and engine noise. The system relies on four microphones embedded in the headliner, which monitor exhaust and engine noise, and assists an onboard frequency generator, which creates counteracting sound waves in the audio system's speakers. This helps keep the vehicle quiet at idle and during drive. The system is deactivated when the windows are rolled down.

AXLE LOCK SYSTEM — IF EQUIPPED

This vehicle is equipped with an electronically locking rear differential. When engaged, this differential locks the axle shafts forcing the wheels to spin at an equal rate. The locking of the rear differential should only be engaged during low-speed, extreme off-road situations where one wheel is likely to not be in contact with the ground. It is not recommended to drive the vehicle with the differentials locked on pavement due to the reduced ability to turn and speed limitations.

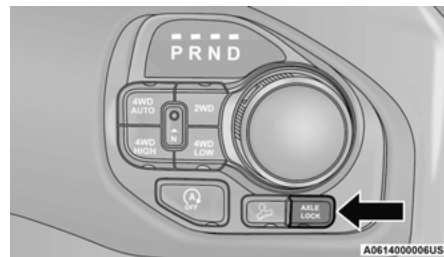

AXLE LOCK Button

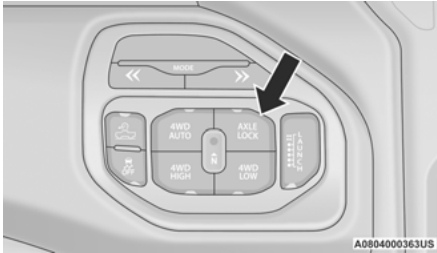

AXLE LOCK Button - RHO Models

CAUTION!

- Do not lock the rear axle on hard surfaced roads. The ability to steer the vehicle is reduced and damage to the drivetrain may occur when the axle is locked on hard surfaced roads.
- Do not try to lock the rear axle if the vehicle is stuck and the tires are spinning. You can damage drivetrain components. Lock the rear axle before attempting situations or navigating terrain, which could possibly cause the vehicle to become stuck.

The locking rear axle is controlled by the AXLE LOCK button.

Under normal driving conditions, the rear axle should be unlocked.

During the command to lock the rear axle, the indicator light will flash until the axle is locked. After the lock command has been successfully executed, the light will remain on solid.

Operating in 4WD LOW the locker can be engaged up to 40 mph (64 km/h) and will remain engaged throughout the 4WD LOW speed range.

Operating the locker in 2WD, 4WD AUTO, and 4WD LOCK/HIGH, the locker can be engaged up to 20 mph (32 km/h). While driving with the locker engaged, if speed exceeds 25 mph (40 km/h), the locker will automatically disengage, but will automatically re-engage at 20 mph (32 km/h).

NOTE:

- RHO rear axle locker will remain locked at any speed when in Baja mode and with ESC Full Off.
- Left to right wheel speed difference may be necessary to allow the rear axle to fully lock. If the indicator light is flashing after selecting the rear axle lock mode, drive the vehicle in a turn or on loose gravel to expedite the locking action.
- The axle locker could become torque locked due to side to side loads on the rear axle. Driving slowly while turning the steering wheel from a left hand turn to a right hand turn or driving in REVERSE for a short distance may be required to release the torque lock and unlock the axles.
- To unlock the rear axle, push the AXLE LOCK button. The AXLE LOCK indicator light will go out when the rear axle is unlocked.

LIMITED-SLIP DIFFERENTIAL — IF EQUIPPED

The limited-slip differential provides additional traction on snow, ice, mud, sand and gravel, particularly when there is a difference between the traction

characteristics of the surface under the right and left rear wheels. During normal driving and cornering, the limited-slip unit performs similarly to a conventional differential. On slippery surfaces, however, the differential delivers more of the driving effort to the rear wheel having the better traction.

The limited-slip differential is especially helpful during slippery driving conditions. With both rear wheels on a slippery surface, a slight application of the accelerator will supply maximum traction. When starting with only one rear wheel on an excessively slippery surface, slight momentary application of the parking brake may be necessary to gain maximum traction.

WARNING!

When servicing vehicles equipped with a limited-slip or locking differential, never run the engine with one rear wheel off the ground as the vehicle may drive through the rear wheel remaining on the ground and result in unintended movement.

Care should be taken to avoid sudden accelerations when both rear wheels are on a slippery surface. This could cause both rear wheels to spin, and allow the vehicle to slide sideways on the crowned surface of a road or in a turn.

POWER STEERING

ELECTRIC POWER STEERING

The electric power steering system will provide increased vehicle response and ease of

maneuverability. The electric power steering system adapts to different driving conditions.

WARNING!

Continued operation with reduced assist could pose a safety risk to yourself and others. Service should be obtained as soon as possible.

Alternate electric power steering efforts can be selected through the Uconnect system.



If the Electric Power Steering warning icon is displayed and the “Service Power Steering” or the “Power Steering Assist Off – Service System” message is displayed within the

instrument cluster display, this indicates the vehicle needs to be taken to an authorized dealer for service  page 116 .

If the Electric Power Steering warning icon is displayed and the “Power Steering System Over Temp” message is displayed on the instrument cluster display, this indicates an over temperature condition in the power steering system. Once driving conditions are safe, pull over and let the vehicle idle for a few moments until the icon and message turn off  page 116 .

NOTE:

- Even if the power steering assistance is no longer operational, it is still possible to steer the vehicle. Under these conditions there will be a substantial increase in steering effort, especially at low speeds and during parking maneuvers.
- If the condition persists, see an authorized dealer for service.

STOP/START SYSTEM — IF EQUIPPED

The Stop/Start function, included with eTorque equipped vehicles, is developed to save fuel and reduce emissions. The system will stop the engine automatically as the vehicle decelerates at low speeds if the required conditions are met. Releasing the brake pedal or shifting out of DRIVE will automatically restart the engine.

Vehicles equipped with eTorque contain a heavy-duty motor generator and an additional hybrid electric battery to store energy from vehicle deceleration used to expand engine off energy storage and for engine startup after a stop, as well as providing engine torque assist when conditions are met to enable this.

AUTOSTOP MODE

The Stop/Start feature is enabled after every normal customer engine start. It will remain in STOP/START NOT READY until you drive forward with a vehicle speed greater than 2 mph (3 km/h). At that time, the system will go into STOP/START READY and if all other conditions are met, the system may go into STOP/START AUTOSTOP ACTIVE Autostop mode.

To Activate The Autostop Mode, The Following Must Occur:

1. The system must be in STOP/START READY state. A STOP/START READY message is displayed in the instrument cluster within the Stop/Start section  page 116.
2. The vehicle must be decelerating and likely coming to a complete stop.

3. The transmission gear selector must be in DRIVE and the brake pedal pressed.

The engine will shut down, the tachometer will move to the zero position and the Stop/Start telltale will illuminate indicating you are in an Autostop. While in an Autostop, the Climate Controls system may automatically adjust airflow to maintain cabin comfort. Customer settings will be maintained upon return to an engine running condition.

POSSIBLE REASONS THE ENGINE DOES NOT AUTOSTOP

Prior to engine shut down, the system will check many safety and comfort conditions to see if they are fulfilled. In following situations, the engine will not Autostop:

- Driver’s seat belt is not buckled
- Driver’s door is not closed
- The vehicle is on a steep grade
- Cabin heating or cooling is in process and an acceptable cabin temperature has not been achieved
- HVAC is set to full defrost mode at a high blower speed
- Engine has not reached normal operating temperature
- Engine or exhaust temperature is too high
- The battery is charging
- The transmission is not in DRIVE
- Hood is open

- Transfer case is in 4WD LOW
- TOW/HAUL mode is selected
- Accelerator pedal input
- Excessive 12 Volt loads
- Brake application is adequate to obtain and maintain a stop

It may be possible to operate the vehicle several consecutive times in extreme conditions and not meet all criteria to enable an Autostop state.

TO START THE ENGINE WHILE IN AUTOSTOP MODE

While in DRIVE, the engine will start when the brake pedal is released or the accelerator pedal is pressed and the transmission will automatically reengage upon engine restart.

Conditions That Will Cause The Engine To Start Automatically While In Autostop Mode

The engine will start automatically when:

- The transmission selector is moved from DRIVE to REVERSE, NEUTRAL, or PARK
- To maintain cabin temperature near the HVAC settings
- HVAC is set to full defrost mode
- 12 Volt demand requires engine restart
- Stop/Start OFF switch is pushed
- Transfer case is in 4WD LOW
- The emissions system override is present

- A Stop/Start system error is present

Conditions That Force An Automatic Shift To Park While In Autostop Mode

The engine will not start automatically and the transmission will be placed in PARK if:

- The driver door is open and brake pedal released
- The driver door is open and the driver seat belt is unbuckled
- The engine hood has been opened
- A Stop/Start system error is present

The engine may then be restarted by moving the transmission shift selector out of PARK (e.g., to DRIVE) or, in some cases, only by a key start. The instrument cluster will display a “SHIFT OUT OF PARK” message, or a “STOP/START KEY START REQUIRED” message, to indicate which action is required ⇨ page 116 .

TO MANUALLY TURN OFF THE STOP/START SYSTEM

Push the Stop/Start OFF switch (located on the switch bank). The light on the switch will illuminate. The “STOP/START OFF” message will appear in the instrument cluster display and the Autostop mode will be disabled ⇨ page 116 .

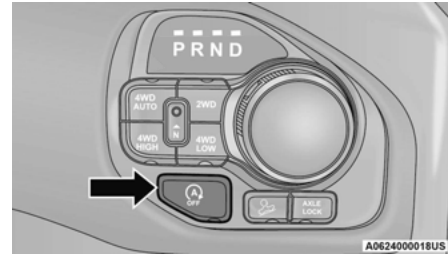

Stop/Start OFF Switch

NOTE:

The Stop/Start system will reset itself back to the ON position every time the ignition is turned OFF and back ON.

TO MANUALLY TURN ON THE STOP/START SYSTEM

Push the Stop/Start OFF switch (located on the switch bank). The light on the switch will turn off.

SYSTEM MALFUNCTION

If there is a malfunction in the Stop/Start system, the system will not shut down the engine. A “SERVICE STOP/START SYSTEM” message will appear in the instrument cluster display ⇨ page 126 .

The system will need to be checked by an authorized dealer.

CRUISE CONTROL SYSTEMS

Your vehicle is equipped with the Adaptive Cruise Control (ACC) system which will adjust the vehicle speed up to the preset speed to maintain a distance with the vehicle ahead.

NOTE:

In vehicles **NOT** equipped with the Active Driving Assist (ADA) system:

- Fixed Speed Cruise Control can be used when ACC is not enabled, and functions as normal cruise control.
- Fixed Speed Cruise Control will not detect vehicles directly ahead of you. Always be aware of the feature selected.
- Only one Cruise Control feature can operate at a time. For example, if Fixed Speed Cruise Control is enabled, Adaptive Cruise Control will be unavailable, and vice versa.

ADAPTIVE CRUISE CONTROL (ACC)

Adaptive Cruise Control (ACC) increases the driving convenience provided by Cruise Control while traveling on highways and major roadways. However, it is not a safety system and not designed to prevent collisions.

ACC will allow you to keep Cruise Control engaged in light to moderate traffic conditions without the constant need to reset your speed. ACC utilizes a radar sensor and a forward facing camera designed to detect a vehicle directly ahead of you to maintain a set speed.

NOTE:

- If the ACC sensor detects a vehicle ahead, ACC will apply limited braking or acceleration (not to exceed

the original set speed) automatically to maintain a preset following distance, while matching the speed of the vehicle ahead.

- Any chassis/suspension or tire size modifications to the vehicle will affect the performance of the Adaptive Cruise Control and Forward Collision Warning system.
- In vehicles **NOT** equipped with the Active Driving Assist system, Fixed Speed Cruise Control (ACC not enabled) will not detect vehicles directly ahead of you. Always be aware of the feature selected.

WARNING!

- Adaptive Cruise Control (ACC) is a convenience system. It is not a substitute for active driver involvement. It is always the driver's responsibility to be attentive of road, traffic, and weather conditions, vehicle speed, distance to the vehicle ahead and, most importantly, brake operation to ensure safe operation of the vehicle under all road conditions. Your complete attention is always required while driving to maintain safe control of your vehicle. Failure to follow these warnings can result in a collision and death or serious personal injury.
- The ACC system:
 - Does not react to pedestrians, oncoming vehicles, and stationary objects (e.g., a stopped vehicle in a traffic jam or a disabled vehicle).
 - Cannot take street, traffic, and weather conditions into account, and may be limited upon adverse sight distance conditions.

WARNING!

- Does not always fully recognize complex driving conditions, which can result in wrong or missing distance warnings.
- Will bring your vehicle to a complete stop while following a vehicle ahead and hold your vehicle for approximately three minutes in the stop position. If the vehicle ahead does not start moving within three minutes the parking brake will be activated, and the ACC system will be canceled.

You should not utilize the ACC system:

- When driving in fog, heavy rain, heavy snow, sleet, heavy traffic, and complex driving situations (i.e., in highway construction zones).
- When entering a turn lane or highway off-ramp; when driving on roads that are winding, icy, snow-covered, slippery, or have steep uphill or downhill slopes.
- When towing a trailer up or down steep slopes.
- When circumstances do not allow safe driving at a constant speed.

Adaptive Cruise Control (ACC) Operation

The buttons on the right side of the steering wheel operate the Adaptive Cruise Control system.

(Continued)

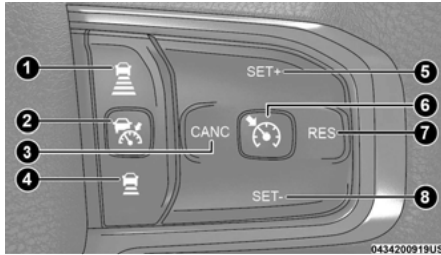

Adaptive Cruise Control Buttons

- 1 – Distance Increase Button
- 2 – Adaptive Cruise Control (ACC) On/Off
- 3 – CANC/Cancel
- 4 – Distance Decrease Button
- 5 – SET (+)/Accel
- 6 – Fixed Speed Cruise Control On/Off (If Equipped)
- 7 – RES/Resume
- 8 – SET (-)/Decel

Adaptive Cruise Control (ACC) Menu

The instrument cluster display will show the current system settings for Adaptive Cruise Control (ACC), Active Lane Management (ALM), and the Active Driving Assist (ADA) systems. The information it displays depends on ACC, ALM, and ADA system statuses.

Pushing the Adaptive Cruise Control (ACC) buttons will display one of the following messages in the instrument cluster display:

Adaptive Cruise Control Ready

When ACC is activated but the vehicle speed setting has not been selected, the display will read “Adaptive Cruise Control Ready.”

Adaptive Cruise Control Set

When the SET (+) or the SET (-) button is pushed, the display will read “ACC: XX mph (km/h)”.

When ACC is set, the set speed will show in the instrument cluster display.

The ACC screen may display once again if any of the following ACC activity occurs:

- System Cancel
- Driver Override
- System Off
- ACC Proximity Warning
- ACC Unavailable Warning

Adaptive Cruise Control Off

When ACC is deactivated, the display will read “Adaptive Cruise Control Off”.

The instrument cluster display will return to the last display selected after five seconds of no ACC display activity.

Activating Adaptive Cruise Control (ACC)

The minimum set speed for the ACC system is 20 mph (32 km/h).

When the system is turned on and in the ready state, the instrument cluster display will read “ACC Ready.”

When the system is off, the instrument cluster display will read “Adaptive Cruise Control (ACC) Off.”

NOTE:

You cannot engage ACC under the following conditions:

- When in 4WD Low
- When the brakes are applied
- When the parking brake is applied
- When the automatic transmission is in PARK, REVERSE or NEUTRAL
- When the vehicle speed is below the minimum speed range
- When the brakes are overheated
- When the driver’s door is open at low speeds
- When the driver’s seat belt is unbuckled at low speeds
- When there is a stationary vehicle in front of your vehicle in close proximity
- When Electronic Stability Control (ESC) Full Off mode is active

To Activate/Deactivate

Push and release the Adaptive Cruise Control (ACC) on/off button. The ACC menu in the instrument cluster displays “ACC Ready.”

To turn the system off, push and release the Adaptive Cruise Control (ACC) on/off button again. At this time, the system will turn off and the instrument cluster display will show “Adaptive Cruise Control (ACC) Off.”

WARNING!

Leaving the Adaptive Cruise Control (ACC) system on when not in use is dangerous. You could accidentally set the system or cause it to go faster than you want. You could lose control and have a collision. Always leave the system off when you are not using it.

To Set A Desired ACC Speed

When the vehicle reaches the speed desired, push the SET (+) button or the SET (-) button and release. The instrument cluster display will show the set speed.

NOTE:

Fixed Speed Cruise Control (if equipped) is used without ACC enabled. To change between Adaptive Cruise Control (ACC) and Fixed Speed Cruise Control features, first turn off ACC by pushing the ACC on/off button. Then, turn on Fixed Speed Cruise Control by pushing the Fixed Speed Cruise Control on/off button.

WARNING!

In Fixed Speed Cruise Control mode, the system will not react to vehicles ahead. In addition, the proximity warning does not activate and no alarm will sound even if you are too close to the vehicle ahead since neither the presence of the vehicle ahead nor the vehicle-to-vehicle distance is detected. Be sure to maintain a safe distance between your vehicle and the vehicle ahead. Always be aware which mode is selected.

If ACC is set when the vehicle speed is **below** 20 mph (32 km/h), the set speed will default to 20 mph (32 km/h).

NOTE:

Fixed Speed Cruise Control cannot be set below 20 mph (32 km/h).

If either system is set when the vehicle speed is **above** 20 mph (32 km/h), the set speed shall be the current speed of the vehicle.

NOTE:

- Keeping your foot on the accelerator pedal can cause the vehicle to continue to accelerate beyond the set speed. If this occurs, the message "ACC Driver Override" will display in the instrument cluster display.
- If you continue to accelerate beyond the set speed while ACC is enabled, the system will not control the distance between your vehicle and the vehicle ahead. The vehicle speed will only be determined by the position of the accelerator pedal.

To Cancel

The following conditions cancel the ACC or Fixed Speed Cruise Control systems:

- The brake pedal is applied
- The CANC (cancel) button is pushed
- The Anti-Lock Brake System (ABS) activates
- The trailer brake is applied manually (if equipped)
- The gear selector is removed from the DRIVE position
- The Electronic Stability Control/Traction Control System (ESC/TCS) activates
- The vehicle parking brake is applied

- The Trailer Sway Control (TSC) activates
- The driver switches ESC to Full Off mode
- The braking temperature exceeds normal range (overheated)

The following conditions will only cancel the ACC system:

- Driver seat belt is unbuckled at low speeds
- Driver door is opened at low speeds

To Turn Off

The system will turn off and clear the set speed in memory if:

- The Adaptive Cruise Control (ACC) on/off button is pushed
- The Fixed Speed Cruise Control on/off button is pushed
- The ignition is placed in the OFF position
- 4WD Low is engaged
- The Active Driving Assist (ADA) system (if equipped) is enabled/engaged and the ADA button is pressed

NOTE:

If ADA is not enabled/engaged and the ADA button is pressed, the ACC system will remain on or turn on, depending on the state of ACC at the time of the ADA button press.

To Resume

If there is a set speed in memory, push the RES (resume) button and then remove your foot from the

accelerator pedal. The instrument cluster display will show the last set speed.

Resume can be used at any speed above 20 mph (32 km/h) when only Fixed Speed Cruise Control is being used.

Resume can be used at any speed above 0 mph (0 km/h) when ACC is active.

NOTE:

- If your vehicle is at a standstill for longer than two seconds, then the driver will either have to push the RES (resume) button, or apply the accelerator pedal to reengage the Adaptive Cruise Control (ACC) to the existing set speed.
- ACC cannot be resumed if there is a stationary vehicle in front of your vehicle in close proximity.

WARNING!

The Resume function should only be used if traffic and road conditions permit. Resuming a set speed that is too high or too low for prevailing traffic and road conditions could cause the vehicle to accelerate or decelerate too sharply for safe operation. Failure to follow these warnings can result in a collision and death or serious personal injury.

To Vary The Speed Setting

To Increase Or Decrease The Set Speed

After setting a speed, you can increase the set speed by pushing the SET (+) button, or decrease speed by pushing the SET (-) button.

U.S. Speed (mph)

- Pushing the SET (+), or SET (-) button once will result in a 1 mph speed adjustment. Each subsequent tap of the button results in an adjustment of 1 mph.
- If the button is held down, the set speed will continue to adjust in 5 mph increments until the button is released. The new set speed is reflected in the instrument cluster display.

Metric Speed (km/h)

- Pushing the SET (+), or SET (-) button once will result in a 1 km/h speed adjustment. Each subsequent tap of the button results in an adjustment of 1 km/h.
- If the button is held down, the set speed will continue to adjust in 10 km/h increments until the button is released. The new set speed is reflected in the instrument cluster display.

NOTE:

When you override and push the SET (+) button or SET (-) buttons, the new set speed will be the current speed of the vehicle.

When ACC Is Active

- When you use the SET (-) button to decelerate, if the engine's braking power does not slow the vehicle sufficiently to reach the set speed, the brake system will automatically slow the vehicle.
- The ACC system decelerates the vehicle to a full stop when following the vehicle in front. If your vehicle follows the vehicle in front to a standstill, after two seconds the driver will either have to push the RES (resume) button, or apply the accelerator pedal to reengage the ACC to the existing set speed.

- The ACC system maintains set speed when driving uphill and downhill. However, a slight speed change on moderate hills is normal. In addition, downshifting may occur while climbing uphill or descending downhill. This is normal operation and necessary to maintain set speed. When driving uphill and downhill, the ACC system will cancel if the braking temperature exceeds normal range (overheated).

Setting The Following Distance In ACC

The specified following distance for Adaptive Cruise Control (ACC) can be set by varying the distance setting between four bars (longest), three bars (long), two bars (medium) and one bar (short). Using this distance setting and the vehicle speed, ACC calculates and sets the distance to the vehicle ahead. This distance setting displays in the instrument cluster display.

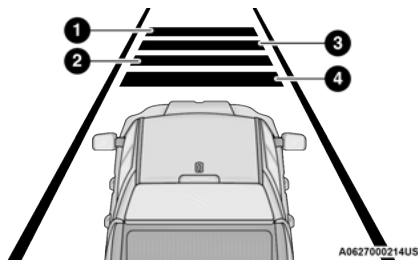

Distance Settings

- 1 — Longest Distance Setting (Four Bars)
- 2 — Medium Distance Setting (Two Bars)
- 3 — Long Distance Setting (Three Bars)
- 4 — Short Distance Setting (One Bar)

To increase the distance setting, push the Distance Increase button and release. Each time the button is pushed, the distance setting increases by one bar (longer).

To decrease the distance setting, push the Distance Decrease button and release. Each time the button is pushed, the distance setting decreases by one bar (shorter).

If there is no vehicle ahead, the vehicle will maintain the set speed. If a slower moving vehicle is detected in the same lane, the instrument cluster display will show the ACC Set With Target Detected Indicator Light, and the system will adjust the vehicle speed automatically to maintain the distance setting, regardless of the set speed.

The vehicle will then maintain the set distance until:

- The vehicle ahead accelerates to a speed above the set speed.
- The vehicle ahead moves out of your lane or view of the sensor.
- The distance setting is changed.
- The system disengages → page 167.

The maximum braking applied by ACC is limited; however, the driver can always apply the brakes manually, if necessary.

NOTE:

The brake lights will illuminate whenever the ACC system applies the brakes.

A Proximity Warning will alert the driver if ACC predicts that its maximum braking level is not sufficient to maintain the set distance. If this occurs, a visual alert "BRAKE!" will flash in the instrument cluster display and a chime will sound while ACC continues to apply its maximum braking capacity.

NOTE:

The "BRAKE!" screen in the instrument cluster display is a warning for the driver to take action and does not mean that the Forward Collision Warning system is applying the brakes autonomously.

Overtake Aid

When driving with Adaptive Cruise Control (ACC) engaged, and following a vehicle, the system will provide an additional acceleration up to the ACC set speed to assist with passing the vehicle. This additional acceleration is triggered when the driver utilizes the left

turn signal and will only be active when passing on the left hand side.

ACC Operation At Stop

In the event that the ACC system brings your vehicle to a standstill while following the vehicle in front, if the vehicle in front starts moving within two seconds of your vehicle coming to a standstill, your vehicle will resume motion without the need for any driver action.

If the vehicle in front does not start moving within two seconds of your vehicle coming to a standstill, the driver will either have to push the RES (resume) button, or apply the accelerator pedal to reengage the ACC to the existing set speed.

NOTE:

After the ACC system holds your vehicle at a standstill for approximately three consecutive minutes, the parking brake will be activated, and the ACC system will be canceled.

While ACC is holding your vehicle at a standstill, if the driver seat belt is unbuckled or the driver door is opened, the parking brake will be activated, and the ACC system will be canceled.

WARNING!

When the ACC system is resumed, the driver must ensure that there are no pedestrians, vehicles or objects in the path of the vehicle. Failure to follow these warnings can result in a collision and death or serious personal injury.

Display Warnings And Maintenance

“WIPE FRONT RADAR SENSOR IN FRONT OF VEHICLE” WARNING

The “ACC/FCW Unavailable Wipe Front Radar Sensor” warning will display and a chime will sound when conditions temporarily limit system performance.

This most often occurs at times of poor visibility, such as in snow or heavy rain. The ACC system may also become temporarily blinded due to obstructions, such as mud, dirt or ice. In these cases, the instrument cluster display will display “ACC/FCW Unavailable Wipe Front Radar Sensor” and the system will deactivate.

The “ACC/FCW Unavailable Wipe Front Radar Sensor” message can sometimes be displayed while driving in highly reflective areas (i.e. ice and snow, or tunnels with reflective tiles). The ACC system will recover after the vehicle has left these areas. Under rare conditions, when the radar is not tracking any vehicles or objects in its path this warning may temporarily occur.

NOTE:

If the “ACC/FCW Unavailable Wipe Front Radar Sensor” warning is active, Fixed Speed Cruise Control is still available.

If weather conditions are not a factor, the driver should examine the sensor. It may require cleaning or removal of an obstruction. The sensor is located in the camera in the center of the windshield, on the forward side of the rearview mirror.

To keep the ACC system operating properly, it is important to note the following maintenance items:

- Always keep the sensor clean. Carefully clear the windshield.
- Do not remove any screws from the sensor. Doing so could cause an ACC system malfunction or failure and require a sensor realignment.
- Do not attach or install any accessories near the sensor, including transparent material. Doing so could cause an ACC system failure or malfunction.

When the condition that deactivated the system is no longer present, the system will return to the “Adaptive Cruise Control Off” state and will resume function by simply reactivating it.

NOTE:

- If the “ACC/FCW Unavailable Wipe Front Radar Sensor” message occurs frequently (e.g. more than once on every trip) without any snow, rain, mud, or other obstructions, have the radar sensor realigned at an authorized dealer.
- Installing a snowplow, front-end protector, an aftermarket grille or modifying the grille is not recommended. Doing so may block the sensor and inhibit ACC/FCW operation.

“CLEAN FRONT WINDSHIELD” WARNING

The “ACC/FCW Limited Functionality Clean Front Windshield” warning will display and a chime will sound when conditions temporarily limit system performance. This most often occurs at times of poor visibility, such as in snow or heavy rain and fog. The ACC system may also become temporarily blinded due to obstructions, such as mud, dirt, or ice on windshield, driving directly into the sun and fog on the inside of glass. In these cases, the instrument cluster

display will show “ACC/FCW Limited Functionality Clean Front Windshield” and the system will have degraded performance.

This message can sometimes be displayed while driving in adverse weather conditions. The ACC/FCW system will recover after the vehicle has left these areas. Under rare conditions, when the camera is not tracking any vehicles or objects in its path this warning may temporarily occur.

If weather conditions are not a factor, the driver should examine the windshield and the camera located on the back side of the inside rearview mirror. They may require cleaning or removal of an obstruction.

When the condition that created limited functionality is no longer present, the system will return to full functionality.

NOTE:

If the “ACC/FCW Limited Functionality Clean Front Windshield” message occurs frequently (e.g. more than once on every trip) without any snow, rain, mud, or other obstructions, have the windshield and forward facing camera inspected at an authorized dealer.

SERVICE ACC/FCW WARNING

If the system turns off, and the instrument cluster displays “ACC/FCW Unavailable Service Required” or “Cruise/FCW Unavailable Service Required”, there may be an internal system fault or a temporary malfunction that limits ACC functionality. Although the vehicle is still drivable under normal conditions, ACC will be temporarily unavailable. If this occurs, try activating ACC again later, following an ignition cycle. If the problem persists, see an authorized dealer.

Precautions While Driving With ACC

NOTE:

- Aftermarket add-ons such as snowplows, lift kits, and brush/grille bars can hinder module performance. Ensure the radar/camera has no obstructions in the field of view.
- Height modifications can limit module performance and functionality.
- Do not put stickers or easy passes over the camera/radar field of view.
- Any modifications to the vehicle that may obstruct the field of view of the radar/camera are not recommended.

In certain driving situations, ACC may have detection issues. In these cases, ACC may brake late or unexpectedly. The driver needs to stay alert and may need to intervene. The following are examples of these types of situations:

TOWING A TRAILER

ACC while towing a trailer is recommended only with an Integrated Trailer Brake Controller. Aftermarket trailer brake controllers will not activate the trailer brakes when ACC is braking.

OFFSET DRIVING

ACC may not detect a vehicle in the same lane that is offset from your direct line of travel, or a vehicle merging in from a side lane. There may not be sufficient distance to the vehicle ahead. The offset vehicle may move in and out of the line of travel, which can cause your vehicle to brake or accelerate unexpectedly.

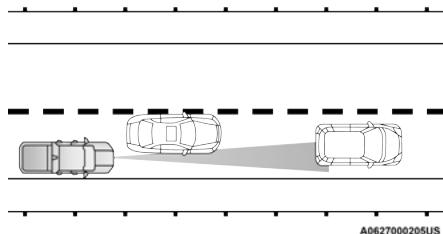

Offset Driving Condition Example

URNS AND BENDS

When driving on a curve with ACC engaged, the system may increase or decrease the vehicle speed for stability, with no vehicle ahead detected. Once the vehicle is out of the curve, the system will resume your original set speed. This is a part of normal ACC system functionality.

NOTE:

On tight turns ACC performance may be limited.

USING ACC ON HILLS

ACC performance may be limited when driving on hills. ACC may not detect a vehicle in your lane depending on the speed, vehicle load, traffic conditions, and the steepness of the hill.

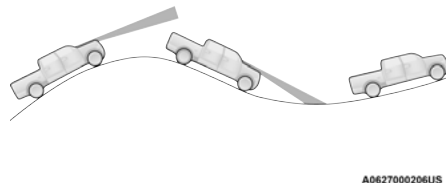

ACC Hill Example

LANE CHANGING

ACC may not detect a vehicle until it is completely in the lane in which you are traveling. In the following lane changing example, ACC has not yet detected the vehicle changing lanes and it may not detect the vehicle until it's too late for the ACC system to take action. ACC may not detect a vehicle until it is completely in the lane. There may not be sufficient distance to the lane-changing vehicle. Always be attentive and ready to apply the brakes if necessary.

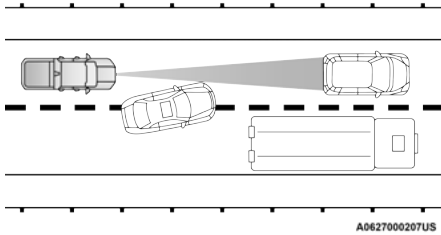

Lane Changing Example

NARROW VEHICLES

Some narrow vehicles traveling near the outer edges of the lane or edging into the lane are not detected until they have moved fully into the lane. There may not be sufficient distance to the vehicle ahead.

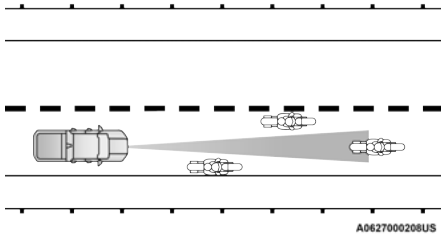

Narrow Vehicle Example

STATIONARY OBJECTS AND VEHICLES

ACC does not react to stationary objects or vehicles. For example, ACC will not react in situations where the vehicle you are following exits your lane and the vehicle ahead is stopped in your lane. It will consider this stopped vehicle a stationary object as it did not previously detect movement from it. Always be attentive and ready to apply the brakes if necessary.

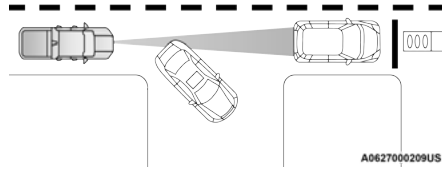

Stationary Object And Stationary Vehicle Example

TRAFFIC SIGN ASSIST SYSTEM — IF EQUIPPED

The Traffic Sign Assist (TSA) system fuses traffic signs detected by a forward facing camera with map data from the vehicle's navigation to display the best available information about the current applicable speed limits. Displayed information includes:

- Unrestricted speed limit
- Conditional speed limit

- No passing zones

NOTE:

The TSA system will automatically display the detected road sign using the unit of measurement (mph or km/h) selected within Uconnect Settings, or within the instrument cluster display.

ACTIVATION/DEACTIVATION

The TSA System can be enabled/disabled within the Uconnect system through the Safety/Driver Assistance menu. System ON is signaled by road signs shown on the instrument cluster display.

TRAFFIC SIGN ASSIST MODES

TSA has three selectable modes of operation that are available through the Uconnect system.

Visual

When Visual is selected, the system will alert the driver when the current speed of the vehicle exceeds the detected speed limit by showing a graphic in the instrument cluster display. The speed limit will be highlighted in red for as long as the speed limit plus offset is exceeded.

Speed Limit Exceeded

When the vehicle's speed exceeds the displayed speed limit by 3 mph (5 km/h), the speed limit sign on the instrument cluster display will show a red outline to alert the driver.

Visual + Chime

When Visual + Chime is selected, the system will alert the driver when the current speed of the vehicle

exceeds the detected speed limit by highlighting the speed limit in red and by sounding a single chime. The speed limit will remain highlighted as long as vehicle speed exceeds the speed limit plus selected offset.

TSA Off

When the TSA system is turned off, the system will not show any traffic signs and no alerts will be issued to the driver.

TSA Offset

The Traffic Sign Assist Offset will allow you to adjust the offset range between 0-10 mph (0-15 kph) within the Uconnect Settings.

INDICATIONS ON THE DISPLAY

Detected traffic signs are shown in the instrument cluster display, and can display any combination of signs at one time (e.g. speed limit, speed limit and supplemental info, and “Do Not Pass” signs) depending on what information is available.

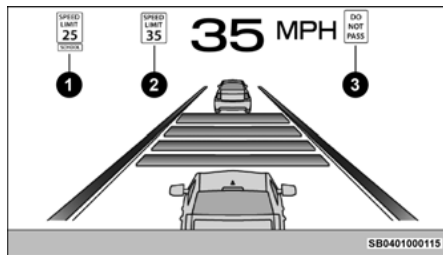

Traffic Signs Recognized (12.3 Inch Cluster Shown)

- 1 – Conditional Speed Limit Detected (School Zone)
- 2 – Current Speed Limit
- 3 – No Passing Zone Detected

NOTE:

Location of traffic sign assist icons may vary depending on the size of your instrument cluster.

Supplemental Information

Supplemental information may be displayed, along with a newly detected speed limit, indicating special circumstances of which the driver should be aware. Available supplemental information includes:

- School
- Work

WARNING!

Traffic Sign Assist (TSA) is a convenience system. It is not a substitute for active driver involvement. It is always the driver's responsibility to be attentive of road, traffic, and weather conditions, vehicle speed, distance to the vehicle ahead and, most importantly, brake operation to ensure safe operation of the vehicle under all road conditions. Your complete attention is always required while driving to maintain safe control of your vehicle. Failure to follow these warnings can result in a collision and death or serious personal injury.

CAUTION!

- Functionality may be limited or the system may not work if the sensor is obstructed.
- The system may have limited operation or not work at all in weather conditions such as heavy rain, hail, and thick fog. Strong light contrasts can influence the recognition capability of the sensor.
- The area surrounding the sensor must not be covered with stickers or any other object.
- Do not tamper or perform any operations in the area of the windshield glass directly surrounding the sensor.
- Clean foreign matters such as bird droppings, insects, snow or ice on the windshield. Use specific detergents and clean cloths to avoid scratching the windshield.

ROUGH ROAD CRUISE CONTROL (RRCC) — IF EQUIPPED



Your vehicle may be equipped with Rough Road Cruise Control (RRCC) which is a 4-High feature intended to fill the gap between Adaptive Cruise Control (ACC) and Selec-Speed Control (SSC). The minimum set speed is 5 mph (8 km/h). The maximum set speed is 20 mph (32 km/h).

NOTE:

Once RRCC is activated, other cruise functions are not possible such as Active Driving Assist (ADA), Active Lane

Management (ALM), Advance Driving Assist (ADAS) and Adaptive Cruise Control (ACC).

ROUGH ROAD CRUISE CONTROL (RRCC) OPERATION

Rough Road Cruise Control is turned on/off by pushing the Selec-Speed Control button located below your rotary electronic gear selector. Once pushed, an LED light will illuminate.

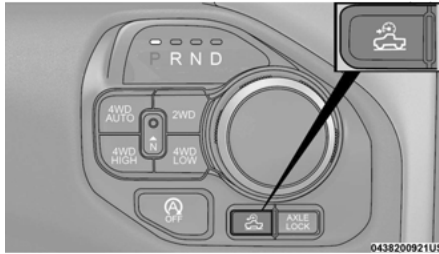

Selec-Speed Control Button

To Activate/Deactivate

Push and release the Selec-Speed Control button. The Rough Road Cruise Control menu in the instrument cluster displays “Rough Road Cruise Control Ready.”

To turn the system off, push and release the Selec-Speed Control button again. At this time, the system will turn off and the instrument cluster displays “Rough Road Cruise Control Off.”

To Set A Desired Speed

When the vehicle reaches the speed of 5 mph (8 km/h), push the SET (+) button or the SET (-) button and release. The instrument cluster display will show the set speed. With speed set, holding SET (+) button or the SET (-) continues incrementing the speed by 1, not by 5 as with ACC.

NOTE:

Rough Road Cruise Control cannot be set below 5 mph (8 km/h).

NOTE:

Rough Road Cruise Control cannot be set above 20 mph (32 km/h).

To Cancel

The following conditions cancel the Rough Road Cruise Control system:

- The brake pedal is applied
- The CANC (cancel) button is pushed
- The transfer case is shifted to 4WD Neutral or 4WD Low
- Speed exceeds 30 mph (48 km/h) for 70 seconds or immediately if vehicle speed exceeds 45 mph (72 km/h) due to driver override
- The gear selector is removed from the DRIVE position
- The vehicle parking brake is applied
- The braking temperature exceeds normal range (overheated)

To Resume

If the Selec-Speed Control button is still activated, push the RES (resume) button and remove your foot from the accelerator pedal. The instrument cluster display will show the last set speed.

Resume can be used at any speed between 5 mph (8 km/h) and 20 mph (32 km/h).

WARNING!

The Resume function should only be used if traffic and road conditions permit. Resuming a set speed that is too high or too low for prevailing traffic and road conditions could cause the vehicle to accelerate or decelerate too sharply for safe operation. Failure to follow these warnings can result in a collision and death or serious personal injury.

4

PARKSENSE FRONT/REAR PARK ASSIST SYSTEM

The ParkSense Park Assist system provides visual and audible indications of the distance between the rear and/or front fascia/bumper and a detected obstacle when backing up or moving forward (e.g. during a parking maneuver). If your vehicle is equipped with the automatic braking function, the vehicle brakes may be automatically applied and released when the vehicle is in REVERSE if the system detects a possible collision with an obstacle.

NOTE:

- The driver can disable the automatic braking function by turning ParkSense off via the ParkSense

switch. The driver can also override automatic braking by changing the gear or by pressing the gas pedal over 90% of its capacity during the braking event.

- Automatic brakes will not be available if the vehicle is in 4WD Low.
- Automatic brakes will not be available if there is a fault in the brake module.
- Automatic brakes will not be available if there is a faulted condition detected with the ParkSense Park Assist system or the Braking System.
- The automatic braking function may only be applied if the vehicle deceleration is not enough to avoid colliding with a detected obstacle.
- The automatic braking function may not be applied fast enough for obstacles that move toward the rear of the vehicle from the left and/or right sides.
- The automatic braking function can be enabled/disabled from the Customer Programmable Features section of the Uconnect system.
- ParkSense will retain its last known configuration state for the automatic braking function through ignition cycles.
- Trailer hitch ball assembly may cause false braking events if left attached after towing.
- Automatic brakes will not be available if the rear park assist system is turned off.

The automatic braking function is intended to assist the driver in avoiding possible collisions with detected obstacles when backing up in REVERSE gear.

NOTE:

- The system is designed to assist the driver and not to substitute the driver.
- The driver must stay in full control of the vehicle's acceleration and braking and is responsible for the vehicle's movements.

For limitations of this system and usage precautions, see  page 179 .

ParkSense will retain the last system state (enabled or disabled) from the last ignition cycle when the ignition is placed in the ON/RUN position.

ParkSense can be active only when the gear selector is in REVERSE or DRIVE. If ParkSense is enabled while in one of these gears, the system will remain active until the vehicle speed is increased to approximately 7 mph (11 km/h) or above. A warning will appear in the instrument cluster display indicating the vehicle speed is above ParkSense operating speed while in REVERSE. The system will become active again if the vehicle speed is decreased to less than approximately 6 mph (9 km/h).

PARKSENSE SENSORS

The six ParkSense sensors, located in the front fascia/bumper, monitor the area in front of the vehicle that is within the sensors' field of view, and the four ParkSense sensors (six if equipped with Active ParkSense), located in the rear fascia/bumper, monitor the area behind the vehicle that is within the sensors' field of view. The front sensors can detect obstacles from approximately 12 inches (30 cm) up to 47 inches (120 cm) from the front fascia/bumper. The rear sensors can detect obstacles from approximately 12

inches (30 cm) up to 79 inches (200 cm). These distances depend on the location, type and orientation of the obstacle in the horizontal direction.

PARKSENSE WARNING DISPLAY

The ParkSense Warning screen is located within the instrument cluster display  page 116. It provides visual warnings to indicate the distance between the rear fascia/bumper and/or front fascia/bumper and the detected obstacle.

PARKSENSE DISPLAY

The warning display will turn on indicating the system status when the vehicle is in REVERSE or when the vehicle is in DRIVE and an obstacle has been detected.

The system will indicate a detected obstacle by showing a single arc in the left, right, or center regions based on the obstacle's distance and location relative to the vehicle.

If an obstacle is detected in the furthest two center front region arcs, they will have no chime. The display will show a single solid arc for the furthest arc and a flashing arc for the second furthest. As the vehicle moves closer to the obstacle, the display will show the single arc moving closer to the vehicle and a fast chime will be heard and will change from fast to continuous.

If an obstacle is detected in the left and/or right front region, the display will show a single flashing arc in the left and/or right front region and will produce a fast chime. As the vehicle moves closer to the obstacle, the display will show the single arc moving closer to the vehicle and the tone will change from fast to continuous.

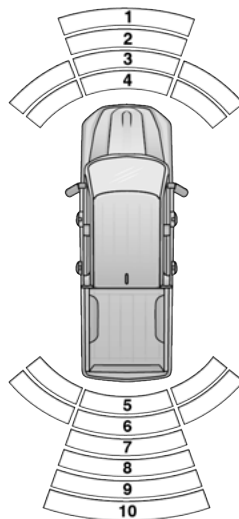

Front/Rear ParkSense Arcs

- 1 – No Tone/Solid Arc
- 2 – No Tone/Flashing Arc
- 3 – Fast Tone/Flashing Arc
- 4 – Continuous Tone/Solid Arc
- 5 – Continuous Tone/Solid Arc

- 6 – Fast Tone/Flashing Arc
- 7 – Fast Tone/Flashing Arc
- 8 – Slow Tone/Solid Arc
- 9 – Slow Tone/Solid Arc
- 10 – Single 1/2 Second Tone/Solid Arc

#0629000255US

The vehicle is close to the obstacle when the display shows one flashing arc and sounds a continuous tone. The following chart shows the warning alert operation when the system is detecting an obstacle:

WARNING ALERTS FOR REAR							
Rear Distance (inches/cm)	Greater than 79 inches (200 cm)	79-59 inches (200-150 cm)	59-47 inches (150-120 cm)	47-39 inches (120-100 cm)	39-25 inches (100-65 cm)	25-12 inches (65-30 cm)	Less than 12 inches (30cm)
Audible Alert (Chime)	None	Single 1/2 Second Tone	Slow	Slow	Fast	Fast	Continuous
Arcs-Left	None	None	None	None	None	6th Flashing	5th Solid
Arcs-Center	None	10th Solid	9th Solid	8th Solid	7th Flashing	6th Flashing	5th Solid
Arcs-Right	None	None	None	None	None	6th Flashing	5th Solid
Radio Volume Reduced	No	Yes	Yes	Yes	Yes	Yes	Yes

WARNING ALERTS FOR FRONT						
Front Distance (inches/cm)	Greater than 47 inches (120 cm)	47-39 inches (120-100 cm)	39-25 inches (100-65 cm)	25-12 inches (65-30 cm)	Less than 12 inches (30 cm)	
Audible Alert (Chime)	None	None	None	Fast	Continuous	
Arcs-Left	None	None	None	3rd Flashing	4th Solid	
Arcs-Center	None	1st Solid	2nd Flashing	3rd Flashing	4th Solid	
Arcs-Right	None	None	None	3rd Flashing	4th Solid	
Radio Volume Reduced	No	No	No	Yes	Yes	

NOTE:

ParkSense will reduce the volume of the radio, if on, when the system is sounding an audio tone.

ParkSense Camera Activation — If Equipped

If the ParkSense system detects an obstacle, a camera image will display in the radio. The camera will continue to display as long as the ParkSense system continues to detect an object. This can be turned on or off in the Uconnect system ⇨ page 227.

Front Park Assist Audible Alerts

ParkSense will turn off the Front Park Assist audible alert (chime) after approximately three seconds when an obstacle has been detected, the vehicle is stationary, and brake pedal is applied.

Adjustable Chime Volume Settings

The Front and Rear chime volume settings are programmable through the Uconnect system ⇨ page 227.

ENABLING AND DISABLING FRONT AND/OR REAR PARKSENSE

Front ParkSense can be enabled and disabled with the Front ParkSense switch.

Rear ParkSense can be enabled and disabled with the Rear ParkSense switch.

When the Front or Rear ParkSense switch is pushed to disable the system, the instrument cluster display ⇨ page 116 will show a vehicle graphic of the Front or Rear ParkSense on/off state for two seconds.

When the gear selector is moved to REVERSE and the Front or Rear system is disabled, the instrument cluster display will show a vehicle graphic with "OFF" on the corresponding side. This vehicle graphic will be displayed for as long as the vehicle is in REVERSE.

NOTE:

Arc alerts from the enabled ParkSense system, will interrupt the five second messages, and the instrument cluster display will show the vehicle graphic with the corresponding arcs and "OFF" message.

The Front or Rear ParkSense switch LED will be on when Front or Rear ParkSense is disabled or requires service. The Front or Rear ParkSense switch LED will be off when the Front or Rear system is enabled. If the Front or Rear ParkSense switch is pushed, and the system requires service, the Front or Rear ParkSense switch LED will blink momentarily, and then the LED will be on.

SERVICE THE PARKSENSE PARK ASSIST SYSTEM

During vehicle start up, when the ParkSense System has detected a faulted condition, the instrument cluster will actuate a single chime, once per ignition cycle, and it will display the "Parksense Unavailable Wipe Rear Sensors", "Parksense Unavailable Wipe Front Sensors", or the "Parksense Unavailable Service Required" message for five seconds. When the gear selector is moved to REVERSE and the system has detected a faulted condition, the instrument cluster display will display a "Wipe Off" message on the corresponding blocked system while the vehicle is in

REVERSE. The system will continue to provide arc alerts for the side that is functioning properly.

If "Parksense Unavailable Wipe Rear Sensors" or "Parksense Unavailable Wipe Front Sensors" appears in the instrument cluster display make sure the outer surface and the underside of the rear fascia/bumper and/or front fascia/bumper is clean and clear of snow, ice, mud, dirt or other obstructions and then cycle the ignition. If the message continues to appear see an authorized dealer.

NOTE:

Water from a car wash or road slush in freezing weather may also cause sensors to become blocked.

If the "Parksense Unavailable Service Required" message appears in the instrument cluster display, see your authorized dealer.

CLEANING THE PARKSENSE SYSTEM

Clean the ParkSense sensors with water, car wash soap and a soft cloth. Do not use rough or hard cloths. Do not scratch or poke the sensors.

PARKSENSE SYSTEM USAGE PRECAUTIONS**NOTE:**

- Ensure that the front and rear fascias/bumpers are free of snow, ice, mud, dirt and debris to keep the ParkSense system operating properly.
- Jackhammers, large trucks, and other vibrations could affect the performance of ParkSense.
- When you turn Front or Rear ParkSense off, the instrument cluster display will show a vehicle graphic of the Front or Rear ParkSense on/off state for two

seconds. Furthermore, once you turn Front or Rear ParkSense off, it remains off until you turn it on again, even if you cycle the ignition.

- When you move the gear selector to the REVERSE position and Front or Rear ParkSense is turned off, the instrument cluster display will show a vehicle graphic with "OFF" in the corresponding side. This vehicle graphic will be displayed for as long as the vehicle is in REVERSE.
- ParkSense, when on, will reduce the volume of the radio when it is sounding a tone.
- Clean the ParkSense sensors regularly, taking care not to scratch or damage them. The sensors must not be covered with ice, snow, slush, mud, dirt or debris. Failure to do so can result in the system not working properly. The ParkSense system might not detect an obstacle behind or in front of the fascia/bumper, or it could provide a false indication that an obstacle is behind or in front of the fascia/bumper.
- Use the ParkSense switch to turn the ParkSense system off if obstacles such as bicycle carriers, trailer hitches, etc. are placed near the rear fascia/bumper. Failure to do so can result in the system misinterpreting a close obstacle as a sensor problem, causing the "ParkSense Unavailable Service Required" message to be appear in the instrument cluster display.
- ParkSense should be disabled when the tailgate is in the lowered or open position. A lowered tailgate could provide a false indication that an obstacle is behind the vehicle and could also cause a false braking event.
- The Rear ParkSense system will automatically disable when the system detects that a trailer with

trailer brakes has been connected to the Integrated Trailer Brake Module.

- The Front ParkSense system will automatically disable if a snowplow has been connected to the vehicle.

WARNING!

- Drivers must be careful when backing up even when using ParkSense. Always check carefully behind your vehicle, look behind you, and be sure to check for pedestrians, animals, other vehicles, obstructions, and blind spots before backing up. You are responsible for safety and must continue to pay attention to your surroundings. Failure to do so can result in serious injury or death.
- Before using ParkSense, it is strongly recommended that the ball mount and hitch ball assembly be disconnected from the vehicle when the vehicle is not used for towing. Failure to do so can result in injury or damage to vehicles or obstacles because the hitch ball will be much closer to the obstacle than the rear fascia/bumper when the vehicle sounds the continuous tone. Also, the sensors could detect the ball mount and hitch ball assembly, depending on its size and shape, and give a false indication that an obstacle is behind the vehicle, and could cause false braking.

CAUTION!

- ParkSense is only a parking aid and it is unable to recognize every obstacle, including small

(Continued)

CAUTION!

obstacles. Parking curbs might be temporarily detected or not detected at all. Obstacles located above or below the sensors will not be detected when they are in close proximity.

- The vehicle must be driven slowly when using ParkSense in order to be able to stop in time when an obstacle is detected. It is recommended that the driver looks over his/her shoulder when using ParkSense.

PARKSENSE ACTIVE PARK ASSIST SYSTEM — IF EQUIPPED

The ParkSense Active Park Assist system is intended to assist the driver during parallel and perpendicular parking maneuvers. The system works by identifying a proper parking space, providing audible/visual instructions, and controlling the steering wheel only, or the accelerator, gear selector, brakes, and the steering wheel. Depending on the driver's parking maneuver selection, the ParkSense Active Park Assist system is capable of maneuvering a vehicle into a parallel or a perpendicular parking space on either side (i.e., driver side or passenger side).

Two types of ParkSense Active Park Assist modes are available:

- Full-Automatic Mode
- Steering Only Mode

ParkSense Automated Parking

The automated system detects a vacant parking spot between two consecutive parking lines, two parked vehicles, or one line and one vehicle, and controls the accelerator, gear selector, brakes, and steering wheel. In this mode, the system also provides obstacle detection by providing visual and audible warnings and automatic braking to avoid a collision.

Steering-Only Mode

The automated system detects a vacant parking spot between two consecutive parking lines, two parked vehicles, or one line and one vehicle, and controls the steering wheel only. The driver maintains control of the accelerator, gear selector and brakes. In this mode, the system also provides obstacle detection by providing visual and audible warnings and automatic braking to avoid a collision.

You can switch between Full Assist mode and Steering-Only mode in the Uconnect Settings ➡ page 227.

NOTE:

- The driver is always responsible for controlling the vehicle, responsible for any surrounding objects, and must intervene as required.
- The system is designed to assist the driver and not to substitute the driver.
- During an automated maneuver, if the driver touches the steering wheel after being instructed to remove their hands from the steering wheel, the system will cancel, and the driver will be required to manually complete the parking maneuver.
- The system may not work in all conditions (e.g. environmental conditions such as heavy rain, snow,

etc., or if searching for a parking space that has surfaces that will absorb the ultrasonic sensor waves).

- New vehicles from an authorized dealership must have at least 30 miles (48 km) accumulated before the ParkSense Active Park Assist system is fully calibrated and performs accurately. This is due to the system's dynamic vehicle calibration to improve the performance of the feature. The system will also continuously perform the dynamic vehicle calibration to account for differences such as over or under inflated tires and new tires.

ENABLING AND DISABLING THE PARKSENSE ACTIVE PARK ASSIST SYSTEM



The ParkSense Active Park Assist system can be enabled and disabled with the ParkSense Active Park Assist switch, located on the right-hand side of the Uconnect screen faceplate.

To enable the ParkSense Active Park Assist system, push the ParkSense Active Park Assist switch once (LED turns on). Pushing the switch a second time will disable the system (LED turns off).

The ParkSense Active Park Assist system will turn off automatically for any of the following conditions:

- Parking maneuver is completed
- Vehicle speed is greater than 28 mph (45 km/h) when searching for a parking space during an automated maneuver
- Vehicle speed is greater than 5 mph (7 km/h) active steering guidance into the parking space

- Steering wheel is touched during active steering guidance into the parking space
- The gas pedal or brake pedal is pressed during active steering guidance into the parking space
- ParkSense Front and Rear Park Assist switch is pushed
- Any of the doors are opened during an automated maneuver
- Tailgate is opened
- A trailer is connected
- Vehicle is in 4WD Low
- Cruise Control, Adaptive Cruise Control, or Active Driving Assist systems are engaged
- Electronic Stability Control/Anti-Lock Braking System intervention

The ParkSense Active Park Assist system allows a maximum number of shifts between DRIVE and REVERSE. If the maneuver cannot be completed within the maximum amount of shifts, the system will cancel and the instrument cluster display will instruct the driver to complete the maneuver manually.

The ParkSense Active Park Assist system will only operate and search for a parking space when the following conditions are present:

- Gear selector is in DRIVE
- Ignition is in the RUN position
- ParkSense Active Park Assist switch is activated
- All of the doors are closed

- Tailgate is closed
- Vehicle speed is less than 25 mph (40 km/h) during an automated maneuver
- The outer surface and the underside of the front and rear fascias/bumpers are clean and clear of snow, ice, mud, dirt or other obstructions.

NOTE:

- During the automated parking seeking phase, if the vehicle is driven above approximately 25 mph (40 km/h), the instrument cluster display will instruct the driver to slow down. If the vehicle is driven above approximately 28 mph (45 km/h), the system will cancel. The driver must then reactivate the system by pushing the ParkSense Active Park Assist switch.

When pushed, the LED on the ParkSense Active Park Assist switch will illuminate and remain illuminated until turned off or the parking procedure is completed. If the system is faulted or unavailable, when the button is pressed, the LED on the ParkSense Active Park Assist switch will blink momentarily.

When the ParkSense Active Park Assist system is enabled, you can select between Park or Exit in the Uconnect system. From there, you can select a parallel or perpendicular maneuver.

PARKSENSE AUTOMATIC PARK ASSIST — FULL ASSIST MODE

Parallel/Perpendicular Parking Space Assistance Operation

When the ParkSense Active Park Assist system is enabled, the driver must press “Park” on the Uconnect

display. The system will begin searching for valid parallel and perpendicular parking spaces on either side of the vehicle.

NOTE:

- The driver needs to make sure that the selected parking space for the maneuver remains free and clear of any obstructions (e.g. pedestrians, bicycles, etc.).
- The driver is responsible to ensure that the selected parking space is suitable for the maneuver and free/clear of anything that may be overhanging or protruding into the parking space (e.g., ladders, tailgates, etc. from surrounding objects/vehicles).
- When searching for a parking space, the driver should drive as parallel or perpendicular (depending on the type of maneuver) to other vehicles as possible.
- While the vehicle is in DRIVE, there will be a full screen image in the Uconnect display. If the driver shifts to REVERSE while searching for a parking space, a camera image will appear in the Uconnect display with a “Shift To Drive” message.

Both types of valid spaces (parallel and perpendicular) will be displayed in the Uconnect display as they are found. The available spaces will update in real time.

The automated system will detect a vacant parking spot between two consecutive parking lines, two parked vehicles, or between one parking line and one vehicle.

When valid parking spaces have been found, the driver will be prompted to stop the vehicle.

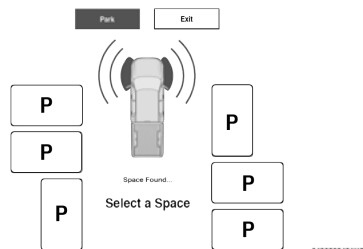
**Select A Space**

The driver can then select a parking space by pressing the desired space on the Uconnect display.

NOTE:

If a space selection is attempted before the vehicle is stopped, a warning screen will appear in the Uconnect display with instructions to stop the vehicle to make a selection.

If the driver selects a perpendicular parking space, the system will prompt the driver to choose a Forward or Reverse parking method.



Choose Parking Method

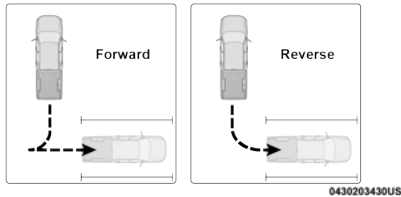

Choose Perpendicular Parking Method

NOTE:

You can press the “Back” button on the display to return to the parking space selection screen and select a different space.

Once the parallel or perpendicular parking maneuver selection has been made, a message will appear in the display with instructions to press the brake pedal and hold down the Active Park Assist switch. This conditions must be met in order to begin the parking maneuver. The message also instructs the driver to hold the Active Park Assist switch down for the entire maneuver.

The system will then instruct the driver to remove hands from the steering wheel and feet from the pedals. This screen will be shown for a minimum of two seconds, or until the driver releases the brake pedal.

When the parking sequence is initiated by the driver after the previously described conditions are met, the Uconnect system will display a Top View along with either a rear camera view (if the vehicle is placed in

REVERSE) or a forward camera view (if the vehicle is placed in DRIVE).

The Top View will have integrated ParkSense arcs in the image at the front and rear of the vehicle. The arcs will change color from yellow to red corresponding the distance zones to the oncoming object.

The system will then perform the parking maneuver. Once the maneuver is complete, the vehicle will automatically shift into PARK.

The system will display a “Complete!” message and instruct the driver to release the Active Park Assist switch.

Once the Active Park Assist switch is released, a chime will sound and the LED on the switch will turn off. After approximately five seconds, the previous Uconnect screen will display.

NOTE:

- It is the driver's responsibility to use the brake and stop the vehicle. The driver should check their surroundings and be prepared to stop the vehicle either when instructed to, or when driver intervention is required.
- When the system instructs the driver to remove their hands from the steering wheel, the driver should check their surroundings and begin to back up slowly.
- The system will cancel the maneuver if the vehicle speed exceeds 4 mph (7 km/h) during Full Assist mode into the parking space. The driver is then responsible for completing the maneuver if the system is canceled.

- If the system is canceled during the maneuver for any reason, the driver must take control of the vehicle.

WARNING!

- Drivers must be careful when performing parallel or perpendicular parking maneuvers even when using the ParkSense Active Park Assist system. Always check carefully behind and in front of your vehicle, look behind and in front of you, and be sure to check for pedestrians, animals, other vehicles, obstructions, and blind spots before backing up and moving forward. You are responsible for safety and must continue to pay attention to your surroundings. Failure to do so can result in serious injury or death.
- Before using the ParkSense Active Park Assist system, it is strongly recommended that the ball mount and hitch ball assembly be disconnected from the vehicle when the vehicle is not used for towing. Failure to do so can result in injury or damage to vehicles or obstacles because the hitch ball will be much closer to the obstacle than the rear fascia/bumper when the vehicle sounds the continuous tone. Also, the sensors could detect the ball mount and hitch ball assembly, depending on its size and shape, giving a false indication that an obstacle is behind the vehicle.

CAUTION!

- The ParkSense Active Park Assist system is only a parking aid and it is unable to recognize every

(Continued)

CAUTION

obstacle, including small obstacles. Parking curbs might be temporarily detected or not detected at all. Obstacles located above or below the sensors will not be detected when they are in close proximity.

- The vehicle must be driven slowly when using the ParkSense Active Park Assist system in order to be able to stop in time when an obstacle is detected. It is recommended that the driver looks over his/her shoulder when using the ParkSense Active Park Assist system.

Exiting A Parking Space

Enable the ParkSense Active Park Assist system by pressing the ParkSense Active Park Assist switch. To initiate a parking space exit maneuver, the vehicle must be stopped, and the driver must press "Exit" on the Uconnect display.

NOTE:

If the system detects that it is unsafe to perform an exit maneuver on either side, such as when the vehicle is positioned too close to a curb or a wall, the exit side selection will be greyed out. If exit procedures are unavailable on both sides, the exit button will also be greyed out.

The exit method options for parallel parking are Forward Left and Forward Right.

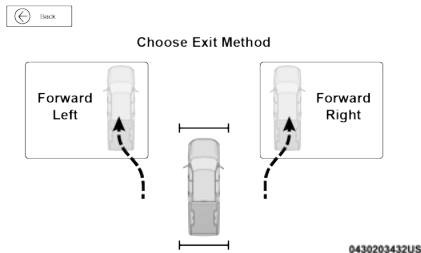

Choose Exit Method — Parallel Parking

NOTE:

If an exit method selection is attempted before the vehicle is stopped, the driver will be instructed to stop the vehicle to make a selection.

After the driver chooses a parallel exit side, a message appears in the Uconnect display with instructions to hold the brake pedal and hold down the Active Park Assist switch. Both of these conditions must be met before the maneuver can begin.

When the Active Park Assist switch is held down, the turn signal for the chosen exit side will turn on automatically.

The system will then instruct the driver to remove hands from the steering wheel and feet from the pedals. This screen will be shown for a minimum of two seconds, or until the driver releases the brake pedal.

When the exit sequence is initiated by the driver after the previously described conditions are met, the Uconnect system will display a Top View along with either a rear camera view (if the vehicle is placed in

REVERSE) or a forward camera view (if the vehicle is placed in DRIVE), and the exit maneuver will begin.

The Top View will have integrated ParkSense arcs in the image at the front and rear of the vehicle. The arcs will change color from yellow to red corresponding the distance zones to the oncoming object.

The automatic maneuver ends when the vehicle is clear of the parking space, and the display shows the message of a completed maneuver. The vehicle will be in DRIVE and held hydraulically by the brakes until the driver presses the accelerator pedal. The system gives vehicle control back to the driver.

Once the driver regains control of the vehicle, a chime will sound and the LED on the switch will turn off. After approximately five seconds, the previous Uconnect screen will display.

Parking Maneuver Paused/Canceled

Certain conditions can pause or cancel a Fully Automated park or exit maneuver.

The ParkSense Automated Parking system can be paused due to the driver's finger being removed from the Active Park Assist switch and/or an object in the vehicle's path during a parking maneuver.

If one or more of these scenarios occur, automatic braking will bring the vehicle to a stop and hold the vehicle hydraulically by the brakes.

The driver will be instructed to hold the Active Park Assist switch to continue the park or exit maneuver. If the driver does not resume holding the switch down, the maneuver will cancel.

If the maneuver is paused due to an object in the vehicle's path, a message will appear in the Uconnect display. The maneuver will remain paused until the object is no longer in the vehicle's path.

The system can also be paused before the Active Park Assist switch is held down if the driver shifts into REVERSE.

The driver will be instructed to shift to DRIVE to continue the maneuver. If the vehicle is shifted into DRIVE, the process will continue on to the seek/ maneuver selection phase.

PARKSENSE AUTOMATIC PARK ASSIST — STEERING-ONLY MODE

Parallel/Perpendicular Parking Space Assistance Operation

When the ParkSense Active Park Assist system is enabled, the driver must press "Park" on the Uconnect display, and the system will begin searching for valid parallel and perpendicular parking spaces.

NOTE:

You may have to update your selected setting in the Uconnect system to switch to Steering-Only mode → page 227.

NOTE:

- The driver needs to make sure that the selected parking space for the maneuver remains free and clear of any obstructions (e.g. pedestrians, bicycles, etc.).
- The driver is responsible to ensure that the selected parking space is suitable for the maneuver and

free/clear of anything that may be overhanging or protruding into the parking space (e.g., ladders, tailgates, etc. from surrounding objects/vehicles).

- When searching for a parking space, the driver should drive as parallel or perpendicular (depending on the type of maneuver) to other vehicles as possible.
- While the vehicle is in DRIVE, there will be a full screen image in the Uconnect display. If the driver shifts to REVERSE while searching for a parking space, a camera image will appear in the Uconnect display with a "Shift To Drive" message.

Both types of valid spaces (parallel and perpendicular) will be displayed in the Uconnect display as they are found. The available spaces will update in real time.

When valid parking spaces have been found, and the vehicle is not in position, you will be instructed to move forward to position the vehicle for a perpendicular or parallel parking sequence (depending on the type of maneuver being performed).

The system will detect a vacant parking spot between two consecutive lines, two parked vehicles, or between one parking line and one vehicle.

A chime will sound, and the driver will be instructed to stop the vehicle and to select a space. This can be done by pressing the desired space on the Uconnect display.

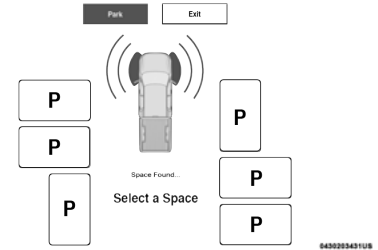

Select A Space

If the driver selects a perpendicular parking space, the system will prompt the driver to choose a Forward or Reverse parking method.

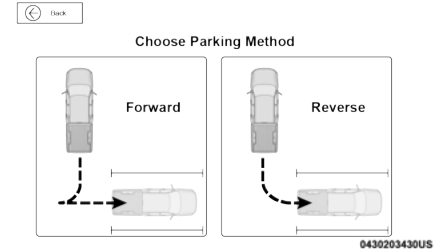

Choose Perpendicular Parking Method

After a parking space has been selected, the driver will be instructed to remove hands from the steering wheel and shift into REVERSE.

Remove Hands from Wheel and Shift to Reverse

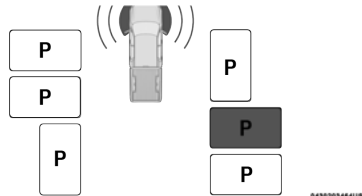

Remove Hands From Wheel And Shift To Reverse

Once active steering begins, a camera image will appear in the Uconnect display with instructions that will display for the duration of the maneuver.

The system may then instruct the driver to wait for steering to complete before then instructing to check the vehicle's surroundings, and move backward.

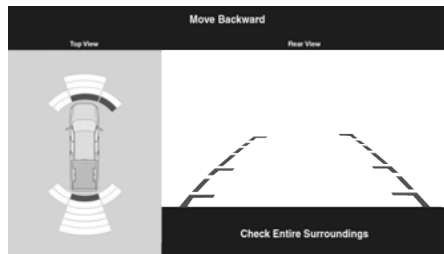

Move Backward

Several more gear shifts (DRIVE and REVERSE) while keeping hands off of the steering wheel will be

instructed to the driver while checking the vehicle's surroundings before completing the parking maneuver.

When the vehicle is in the parking position, the maneuver is complete and the driver will be instructed to check the vehicle's parking position, then shift the vehicle into PARK. The message "Complete! Check Parking Position" will be displayed momentarily.

NOTE:

- It is the driver's responsibility to use the brake and stop the vehicle. The driver should check their surroundings and be prepared to stop the vehicle either when instructed to, or when driver intervention is required.
- It is the driver's responsibility to use the brake and accelerator during the automatic parking maneuver when in Steering-Only mode.
- When the system instructs the driver to remove their hands from the steering wheel, the driver should check their surroundings and begin to back up slowly.
- The ParkSense Active Park Assist system will allow a maximum of eight shifts between DRIVE and REVERSE. If the maneuver cannot be completed within eight shifts, the system will cancel and the instrument cluster display will instruct the driver to complete the maneuver manually.
- The system will cancel the maneuver if the vehicle speed exceeds 7 mph (11 km/h) during active steering guidance into the parking space. The system will provide a warning to the driver at 6 mph (9 km/h) that tells them to slow down. The driver is then responsible for completing the maneuver if the system is canceled.

- If the system is canceled during the maneuver for any reason, the driver must take control of the vehicle.

WARNING!

- Drivers must be careful when performing parallel or perpendicular parking maneuvers even when using the ParkSense Active Park Assist system. Always check carefully behind and in front of your vehicle, look behind and in front of you, and be sure to check for pedestrians, animals, other vehicles, obstructions, and blind spots before backing up and moving forward. You are responsible for safety and must continue to pay attention to your surroundings. Failure to do so can result in serious injury or death.
- Before using the ParkSense Active Park Assist system, it is strongly recommended that the ball mount and hitch ball assembly be disconnected from the vehicle when the vehicle is not used for towing. Failure to do so can result in injury or damage to vehicles or obstacles because the hitch ball will be much closer to the obstacle than the rear fascia/bumper when the vehicle sounds the continuous tone. Also, the sensors could detect the ball mount and hitch ball assembly, depending on its size and shape, giving a false indication that an obstacle is behind the vehicle.

CAUTION!

- The ParkSense Active Park Assist system is only a parking aid and it is unable to recognize every

(Continued)

CAUTION!

obstacle, including small obstacles. Parking curbs might be temporarily detected or not detected at all. Obstacles located above or below the sensors will not be detected when they are in close proximity.

- The vehicle must be driven slowly when using the ParkSense Active Park Assist system in order to be able to stop in time when an obstacle is detected. It is recommended that the driver looks over his/her shoulder when using the ParkSense Active Park Assist system.

Exiting A Parking Space

Enable the ParkSense Active Park Assist system by pressing the ParkSense Active Park Assist switch. To initiate a parking space exit maneuver, the vehicle must be stopped, and the driver must press "Exit" on the Uconnect display.

NOTE:

If the system detects that it is unsafe to perform an exit maneuver on either side, such as when the vehicle is positioned too close to a curb or a wall, the exit side selection will be greyed out. If exit procedures are unavailable on both sides, the exit button will also be greyed out.

The exit method options for parallel parking are Forward Left and Forward Right.

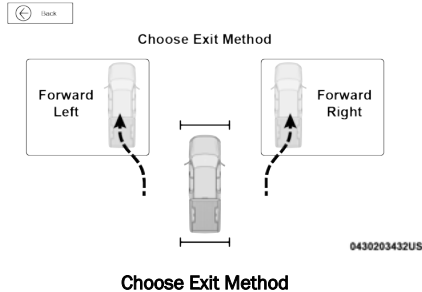

Choose Exit Method

After an exit maneuver method has been selected, the driver will be instructed to remove hands from the steering wheel and shift into REVERSE.

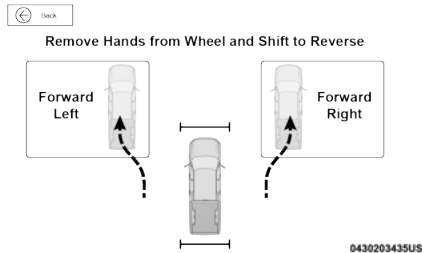

Remove Hands From Wheel And Shift To Reverse — Parallel Parking

Release the steering wheel and use the brake and accelerator pedals and gear selector as instructed, while the system handles the steering automatically for exiting the parking space. If the driver touches or holds

the steering wheel (voluntarily or not) during the exit maneuver, the maneuver will be interrupted.

The automatic maneuver - Steering-Only mode ends when the display shows the message of a completed maneuver and the driver shifts into the PARK position. At the end of the maneuver, the system gives vehicle control back to the driver.

BASE ACTIVE DRIVING ASSIST SYSTEM — IF EQUIPPED

OPERATION

The Active Driving Assist (ADA) system is combined with the Adaptive Cruise Control (ACC) system, and centers the vehicle in the driving lane while traveling at speeds up to 90 mph (145 km/h).

For ACC system operating instructions and system limitations, see page 166.

NOTE:

- The driver should always obey traffic laws and speed limits. Never drive above applicable speed limit restrictions.
- The driver can override ADA at any time by braking, accelerating, or steering the vehicle.

Just like ACC, ADA will maintain a set speed as long as the set distance between your vehicle and the vehicle in front is maintained. ADA will also keep your vehicle centered between the lane lines, and monitor for other vehicles in adjacent lanes by utilizing the Blind Spot Monitoring sensors.

Two types of Active Driving Assist systems are available: Base ADA system and Hands-Free ADA system. If your vehicle is equipped Hands-Free ADA please refer to Hands Free ADA - If Equipped.

Base Active Driving Assist System

The Base ADA system uses sensors within the steering wheel to measure driver attentiveness, and requires that the driver have their hands on the steering wheel at all times.

The system will generally aim to keep the vehicle centered in the lane, but when the driver turns the steering wheel (e.g. to move farther away from a large vehicle in an adjacent lane) the system will reduce its control and enter "co-steering" mode. While in co-steering mode, the system will provide reduced assistance and allow the driver to control the path of the vehicle. Once the driver stops providing input to the steering wheel, the system will require a few seconds to fully resume lane centering assistance, especially during curves.

WARNING!

The driver is always responsible for determining if a lane change is safe. Failure to follow this warning can result in a collision and death or serious personal injury.

WARNING!

The Active Driving Assist (ADA) system is a convenience system. It is not a substitute for active driver involvement. It is always the driver's

(Continued)

WARNING!

responsibility to be attentive of road traffic, weather conditions, vehicle speed, distance to the vehicle ahead, position in the lane compared to other vehicles, and brake operation to ensure safe operation of the vehicle under all road conditions. Your complete attention is always required while driving to maintain safe control of your vehicle. Failure to follow these warnings can result in a collision and death or serious personal injury.

Some states and local laws may require hands to be kept on the steering wheel at all times. For vehicles equipped with the Hands-Free ADA system, **ONLY** remove your hands from the steering wheel if the Hands-Free system is engaged, it is safe to do so, and it is permitted by state and local laws.

You should turn off the Active Driving Assist systems:

- When driving in complex driving situations (e.g. urban environments, construction zones, etc.), adverse weather or low visibility conditions (e.g. rain, snow, fog, sleet, dust), or adverse road conditions (e.g. heavy traffic, worn or missing lane markings, etc.).
- When entering a highway on-ramp or exiting an off-ramp.
- When driving on roads that are icy, snow covered, or slippery.
- When driving during difficult or uncertain conditions.

TURNING ACTIVE DRIVING ASSIST ON OR OFF

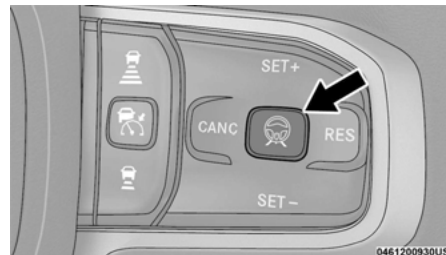

Active Driving Assist On/Off Button

To enable the Active Driving Assist system, proceed as follows:

1. Push the Active Driving Assist on/off button located on the right side of the steering wheel. The steering wheel image will display white in the instrument cluster display until the system is engaged. If ACC was previously disabled, pushing this button will activate BOTH ACC and Active Driving Assist systems.
2. If ACC was engaged before pushing the ADA on/off button, ACC will remain active and ADA will also become engaged (once all other conditions are met).
3. If ACC was not active before pushing the ADA on/off button, push the SET (+) button or the SET (-) button and release when the desired driving speed is shown in the instrument cluster display.

- If desired, adjust the ACC distance setting by pushing the Distance Increase or Distance Decrease buttons.

When all system conditions are met as described in “System Engagement Conditions” in the next section, the system will engage and the steering wheel image in the display will change to green.

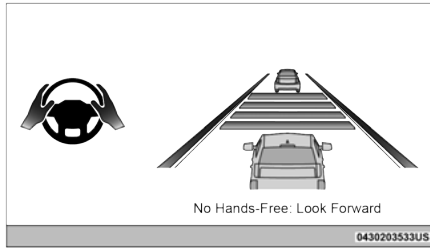

Active Driving Assist Engaged (Steering Wheel Green)

System Engagement Conditions

The following conditions must be met before the system will engage and will NOT be shown in the ADA status message location:

- Active Driving Assist system is enabled (white ADA status icon)
- Turn signal is not activated
- Driver seat belt is buckled
- Driver door is closed

- Driver is not pressing the brake pedal
- Driver has hands on steering wheel

The following conditions must be met before the system will engage and WILL be shown in the ADA status message location:

- System detects visible lane markings
- Vehicle is traveling below 90 mph (145 km/h)
- Vehicle is centered in lane
- Vehicle is not in a tight curve
- Trailer is not connected

NOTE:

For the system to detect the driver's hands on the steering wheel, the wheel must be gripped on the outside. Gripping the inside areas of the steering wheel will not satisfy the hands-on condition to engage the system.

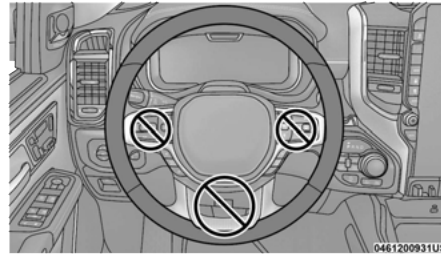

Do Not Grip Inside Of Steering Wheel

System Deactivation

The system will be deactivated in any of the following situations:

- The system initiates a Stop-In-Lane maneuver to stop the vehicle due to driver inattentiveness. The Stop-In-Lane maneuver can be overridden by placing hands on the steering wheel and applying the accelerator or brake pedal. Refer to “Indications On The Display” in the next section for further information
- If lane markings are no longer detected or poor road conditions are experienced
- If the brake pedal is pressed or ACC system is deactivated
- If a turn signal is used (unless a target is in the blind spot zone on the same side the turn signal is being applied)
- If the driver performs an evasive maneuver, applying high torque to the steering wheel for a short duration
- If the driver's seat belt is unbuckled
- If the vehicle speed exceeds 90 mph (145 km/h)
- If the Active Driving Assist on/off button is pushed again (ADA will turn off)
- If the driver steers out of the lane and crosses a lane marking
- If the Forward Collision Warning (FCW) system becomes active and is providing warnings/braking

NOTE:

- ADA will not enable if the system detects a trailer is connected to the vehicle.

- Pushing the Active Driving Assist on/off button or deactivating ACC will turn the system off. All other deactivation conditions will place the system back into the “enabled” state with the steering wheel indicator displayed in white until all engagement conditions are met again.
- When the system is deactivated, Active Lane Management will return to its previous state, and ACC will disable or remain engaged pending system conditions.

INDICATIONS ON THE DISPLAY

The Active Driving Assist system status will be shown in the following locations:

- In the center of the instrument cluster display by selecting the Driver Assist menu.
- In the heads up display by selecting Advanced Layout.
- In the Home tile display by selecting the Driver Assist Tile.

The ADA status will be shown as an indicator light around the cluster.

As the system detects driver inattentiveness as previously described ⇨ page 188, the system status indicator lights will change from off, to yellow, to red. The following indicators will change in color as warnings to the driver escalate:

- Active Driving Assist Indicator (steering wheel icon in the instrument cluster display or Head Up Display [if equipped])
- Glow effect of the instrument cluster display

If driver’s hands are not returned to the steering wheel, the system will deactivate.

Active Driving Assist Indicators (Steering Wheel Icon Only) Is Green

- System is actively steering and providing speed control for the vehicle and the system detects driver is attentive.

Active Driving Assist Indicators Are Yellow

- Driver inattentiveness has been detected, warning the driver to place hands on the steering wheel and look back toward the road.

Active Driving Assist Indicators Are Red

- Driver inattentiveness is still being detected, or driver take-over is required. The driver must return their hands to the steering wheel. Upon driver take-over request, the driver must return their hands to the steering wheel, eyes to the road and (if requested), press the accelerator or brake pedal.

NOTE:

For both Base ADA and Hands-Free ADA (if equipped), the driver **MUST** replace hands on the steering wheel and take control of the vehicle when the system is deactivated.

SYSTEM STATUS

Along with changes in the system’s indicator lights (yellow, and red), the system can also issue several accompanying warnings intended to provide the driver with enough time to react, avoid or mitigate a potential collision.

Base Active Driving Assist System

- Two haptic brake jerk warnings will be issued (red warning light is issued).
- A steering wheel vibration warning (if enabled) will occur if the vehicle crosses a lane marker, for example, when driving on a tight curve. The steering wheel vibration feature can be turned on or off within the Uconnect system ⇨ page 227.

The driver can take control of the vehicle at anytime to override the warnings by pressing the gas or brake pedal, moving the steering wheel, and being attentive to the road.

SYSTEM OPERATION/LIMITATIONS

WARNING!

Active Driving Assist is an SAE Level 2 Driver Assist feature, requiring driver attention at all times. To prevent serious injury or death:

- Always remember that the Active Driving Assist system is a convenience system that cannot accurately detect all situations. Complete attention is always required while driving, even when using the Active Driving Assist system.
- Always remain alert and be ready to take control of the vehicle in the event that the Active Driving Assist system deactivates, or otherwise lacks full functionality as described further before and after this statement.

(Continued)

WARNING!

- Always keep your eyes on the road and hands on the steering wheel when the Base Active Driving Assist system is activated.
- Always keep your eyes on the road when the Hands-Free Active Driving Assist system is activated.
- Maintain a safe distance from other vehicles and pay attention to traffic conditions.
- Do not use a hand held device when either Base, or Hands-Free Active Driving Assist system is engaged.
- Always pay attention to the road when the Hands-Free Active Driving Assist system is engaged. The Active Driving Assist system will not steer to avoid safety hazards, construction zones, objects, or road impediments. You need to take control to steer and brake the vehicle in such situations, and when merging into traffic, exiting the highway, making a turn for crossing traffic, or stopping for traffic control devices.
- Do not place any objects on the steering wheel (e.g. steering wheel covers) which could interfere with the hand detection sensors.

The Base Active Driving Assist system **DOES NOT**:

- Warn or prevent collisions with other vehicles
- Steer your vehicle around stopped vehicles, slower vehicles, construction zones or equipment, pedestrians, or animals
- Respond to traffic lights or stop signs

- Merge onto highways or exit off ramps
- Change lanes
- React to cross traffic

NOTE:

Adaptive Cruise Control (ACC) is a core component of ADA. For ACC system limitations ⇨ page 166 .

The Active Driving Assist system may have limited or reduced functionality when one of the following conditions occur:

- The vehicle's radar sensors and/or forward facing camera is damaged, covered, misaligned, or obstructed (e.g. by mud, ice, snow, etc.)
- If the suspension alignment is not correct, if the vehicle is modified (e.g. lifting or lowering the suspension, installing different sized wheels or tires) or if there has been damage due to road hazards
- Driving near highway toll booths

NOTE:

If damage to the windshield occurs, have the windshield replaced by an authorized dealer as soon as possible.

HANDS-FREE ACTIVE DRIVING ASSIST SYSTEM — IF EQUIPPED

OPERATION

The Active Driving Assist (ADA) system is combined with the Adaptive Cruise Control (ACC) system, and centers

the vehicle in the driving lane while traveling at speeds up to 90 mph (145 km/h).

For ACC system operating instructions and system limitations, see ⇨ page 166.

NOTE:

- The driver should always obey traffic laws and speed limits. Never drive above applicable speed limit restrictions.
- The driver can override ADA at any time by braking, accelerating, or steering the vehicle.

Just like ACC, ADA will maintain a set speed as long as the set distance between your vehicle and the vehicle in front is maintained. ADA will also keep your vehicle centered between the lane lines, and monitor for other vehicles in adjacent lanes by utilizing the Blind Spot Monitoring sensors.

Two types of Active Driving Assist systems are available:

- Base ADA system
- Hands-Free ADA system

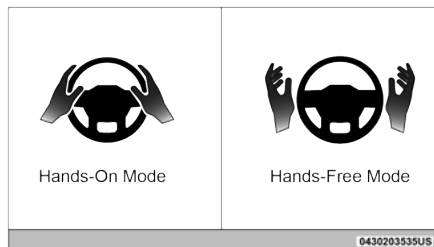

Active Driving Assist Engaged (Steering Wheel Green)

The Hands-Free ADA system has two operating modes:

- Hands-On Mode
- Hands-Free Mode

While driving, the system will switch between modes as determined by road conditions.

Hands-On Mode

Hands-On mode uses sensors within the steering wheel to measure driver attentiveness, and requires that the driver have their hands on the steering wheel at all times.

Hands-Free Mode

Hands-Free mode uses sensors within the steering wheel and a driver monitoring camera located on top of the steering column to monitor driver attentiveness. Hands-Free mode allows the driver to remove their hands temporarily from the steering wheel, when the system is engaged, on approved roadways (see

following note). The system will still require that the driver continue to pay attention to the road and remain ready to take control of the vehicle.

HANDS-FREE SUB FEATURES

Assisted Lane Change

The Assisted Lane Change sub feature is available when operating in Hands-Free mode. The system uses sensors, including Blind Spot Monitoring (BSM) sensors, to determine if a lane change is possible and will indicate that a lane change is available by showing a dashed green lane line graphic on the available side.

If the driver activates the turn signal, and a lane change is available in that direction, the system will begin changing lanes and show a green lane change arrow graphic until the lane change is complete.

NOTE:

The system will only change one lane at a time, if you wish to change multiple lanes, you must request a new lane change after the first one is completed.

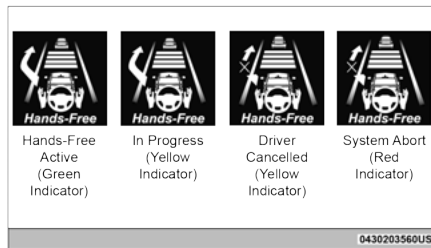

Assisted Lane Change Status

If the lane change is not available, a yellow lane change arrow graphic will be shown, and the system will search for lane change options for several seconds before timing out.

The driver can cancel the lane change by activating the turn signal in the opposite directions, or by overriding the ADA system with the steering wheel, brake pedal, or OFF button.

Below are some of the reasons why Assisted Lane Change may not be available:

- Another vehicle is detected in the destination lane and there is not enough space to complete the lane change.
- The driver is not attentive, and the system is requesting the driver look forward.
- Vehicle speed is below 37 mph (60 km/h).
- The destination lane is not supported for Hands-Free Mode.
- The vehicle is travelling in or approaching a tight curve.
- The vehicle has a turn signal that is not functioning.

WARNING!

The driver is always responsible for determining if a lane change is safe. Failure to follow this warning can result in a collision and death or serious personal injury.

Predictive Curve Speed Control



While operating in Hands-Free mode the ADA system has the ability to slow down when approaching tight curves. This is indicated by an orange arrow icon which takes the place of the ACC target vehicle. If the driver overrides the accelerator pedal during Predictive Curve Speed Control, the system may request driver steering takeover.

Co-steering

While operating in Hands-Free mode, you may keep your hands on the steering wheel at any time. If the system detects driver steering input/torque, it will switch into Hands-On mode. When the driver stops providing steering input, if the conditions for Hands-Free mode are met (including hands on the wheel and eyes on the road), the system will automatically switch back to Hands-Free mode.

While in Hands-On mode, when the driver is providing steering input, the system will reduce its assist but still be active. This allows the driver to maneuver the vehicle more easily (e.g. around potholes) without disengaging the system.

When the driver stops providing steering input/torque, the system will resume regular steering assist within a few seconds. There are no indications other than the resistance of the steering wheel to tell that co-steering is active.

Extended Auto Resume

If equipped with Hands-Free ADA and the system brings your vehicle to a stop while following the vehicle ahead, your vehicle will automatically resume driving without

driver input when the path in front of the vehicle is clear and the driver is attentive.

Assisted Stop-In-Lane

The ADA system can perform an Assisted Stop-In-Lane maneuver when the system requests a driver takeover (red warnings) and the driver does not respond to the takeover.

The Assisted Stop-In-Lane can be overridden at any time by performing ALL of the following:

- Looking forward at the road
- Taking control of the steering wheel
- Pressing the accelerator or brake pedal

During the Assisted Stop, the system will bring the vehicle to a stop in its current lane, secure the vehicle by shifting into PARK and/or applying the parking brake, unlock the doors and activate the hazard lights. Then the vehicle will attempt to place an emergency call through the Assist and SOS system.

NOTE:

- Hands-Free mode is only available on approved roadways. If the system is used on an unapproved road, it will attempt to offer Hands-On mode if conditions are met and inform the driver of the unsupported road the ADA status message. The Hands-Free mode requires an active RAM Connect subscription through the Uconnect Connected Service. If a subscription is not active and the driver engages the ADA system a message will appear explaining that the subscription is required for Hands-Free mode. Hands-On modes do not require a subscription and will be available even when the subscription is not active.

- If previously disabled, activating the Hands-Free Active Driving Assist system will also activate the Forward Collision Warning and Pedestrian Emergency Braking systems.
- If the vehicle is equipped with the Ram Connect (Uconnect Connected Services) package, additional data may be collected through the Uconnect Connected Service system. This includes information about the vehicle's operation, a collision involving the vehicle, the use of the vehicle and its features, and in certain situations, the location and approximate GPS speed of the vehicle. Refer to the Uconnect Radio Instruction Manual for Terms and Conditions and Privacy Statements.
- The driver monitoring camera may record images of the driver during certain crash, or near crash-like situations. To retrieve the images recorded by the camera, special equipment is required and access to the vehicle or the camera is needed.
- Vehicle data may be read from the Hands-Free ADA system with special equipment and access to the vehicle or the Event Data Recorder (EDR).

WARNING!

The Active Driving Assist (ADA) system is a convenience system. It is not a substitute for active driver involvement. It is always the driver's responsibility to be attentive of road traffic, weather conditions, vehicle speed, distance to the vehicle ahead, position in the lane compared to other vehicles, and brake operation to ensure safe operation of the vehicle under all road conditions. Your complete attention is always required while

(Continued)

WARNING!

driving to maintain safe control of your vehicle. Failure to follow these warnings can result in a collision and death or serious personal injury.

Some states and local laws may require hands to be kept on the steering wheel at all times. For vehicles equipped with the Hands-Free ADA system, **ONLY** remove your hands from the steering wheel if the Hands-Free system is engaged, it is safe to do so, and it is permitted by state and local laws.

You should turn off the Active Driving Assist systems:

- When driving in complex driving situations (e.g. urban environments, construction zones, etc.), adverse weather or low visibility conditions (e.g. rain, snow, fog, sleet, dust), or adverse road conditions (e.g. heavy traffic, worn or missing lane markings, etc.).
- When entering a highway on-ramp or exiting an off-ramp.
- When driving on roads that are icy, snow covered, or slippery.
- When driving during difficult or uncertain conditions.

TURNING ACTIVE DRIVING ASSIST ON OR OFF

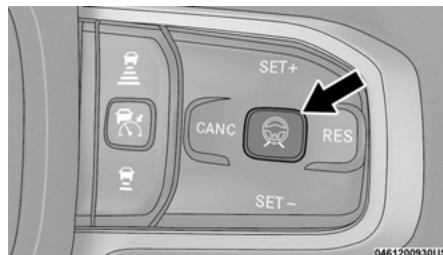

Active Driving Assist On/Off Button

To enable the Active Driving Assist system, proceed as follows:

1. Push the Active Driving Assist on/off button located on the right side of the steering wheel. The steering wheel image will display white in the instrument cluster display until the system is engaged. If ACC was previously disabled, pushing this button will activate BOTH ACC and Active Driving Assist systems.
2. If ACC was engaged before pushing the ADA on/off button, ACC will remain active and ADA will also become engaged (once all other conditions are met).
3. If ACC was not active before pushing the ADA on/off button, push the SET (+) button or the SET (-) button and release when the desired driving speed is shown in the instrument cluster display.

4. If desired, adjust the ACC distance setting by pushing the Distance Increase or Distance Decrease buttons.

When all system conditions are met as described in “System Engagement Conditions” in the next section, the system will engage and the steering wheel image in the display will change to green.

No additional button input is needed to engage in Hands-Free once ADA is enabled via the ADA button on the steering wheel. If the conditions for Hands-Free are met, and the driver is holding the steering wheel and looking at the road, the system will automatically switch into Hands-Free mode.

The ADA system will transition between modes as determined by road condition. In order for the system to transition, the driver must have their hands on the wheel and eyes on the road.

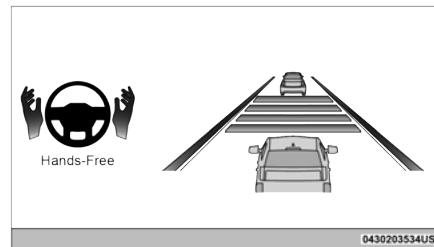

Active Driving Assist Engaged (Steering Wheel Green)

NOTE:

Along with the color change of the steering wheel image, the “glow” effect of the instrument cluster display will also change to green when ADA is engaged.

System Engagement Conditions

The following conditions must be met before the system will engage and will NOT be shown in the ADA status message location:

- Active Driving Assist system is enabled (white ADA status message)
- Turn signal is not activated
- Driver seat belt is buckled
- Driver door is closed
- Driver is not pressing the brake pedal
- Driver has hands on the steering wheel

The following conditions must be met before the system will engage and WILL be shown in the ADA status message location:

- Vehicle is driving on an approved roadway (Hands-Free mode only)
- A Ram Connect subscription is active and the vehicle is receiving a clear cellular signal (Hands-Free mode only)
- Driver paying attention to the road (Hands-Free mode only)
- System detects visible lane markings
- Vehicle is traveling below 90 mph (145 km/h)
- Vehicle is centered in lane

- Vehicle is not in a tight curve
- Trailer is not connected

NOTE:

For the system to detect the driver’s hands on the steering wheel, the wheel must be gripped on the outside. Gripping the inside areas of the steering wheel will not satisfy the hands-on condition to engage the system.

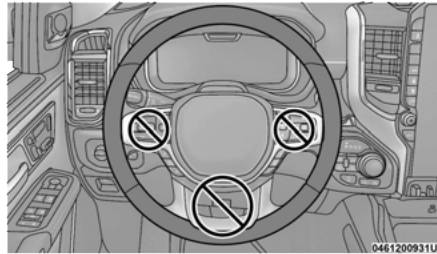
**Do Not Grip Inside Of Steering Wheel****System Deactivation**

The ADA system will be deactivated in any of the following situations while operating in Hands-On mode:

- If the system has detected hands not on the steering wheel, and has gone through the escalation warnings
- If lane markings are no longer detected or poor road conditions are experienced
- If the brake pedal is pressed or ACC system is deactivated

- If a turn signal is used when equipped with Base ADA (unless a target is in the blind spot zone on the same side the turn signal is being applied)
- If the driver performs an evasive maneuver, applying high torque to the steering wheel for a short duration
- If the driver’s seat belt is unbuckled
- If the vehicle speed exceeds 90 mph (145 km/h)
- If the Active Driving Assist on/off button is pushed again (ADA will turn off)
- If the driver steers out of the lane and crosses a lane marking
- If the Forward Collision Warning (FCW) system becomes active and is providing warnings/braking

NOTE:

- ADA will not enable if the system detects a trailer is connected to the vehicle.
- Pushing the Active Driving Assist on/off button or deactivating ACC will turn the system off. All other deactivation conditions will place the system back into the “enabled” state with the steering wheel indicator displayed in white until all engagement conditions are met again.
- When the system is deactivated, the system status indicator lights will turn off, Active Lane Management will return to its previous state, and ACC will disable or remain engaged pending system conditions.

In addition to the above, the ADA system will be deactivated in any of the following situations while operating in Hands-Free mode:

- The driver is not attentive according to the driver monitoring camera or seating position and the system has gone through all escalation warnings (note: this can include cases where the driver is determined to be drowsy by the driver monitoring camera)
- The vehicle is no longer on a supported roadway (note: unsupported roads may include active construction areas or areas of recently completed construction).
- The vehicle is not receiving a clear cellular signal and connection to the cloud.
- The vehicle is not receiving a clear GPS signal (ex. driving in a tunnel).

INDICATIONS ON THE DISPLAY

The Active Driving Assist system status can always be viewed in the instrument cluster display, and status changes are shown by changes in color of the system's indicator lights.

As the system detects driver inattentiveness as previously described  page 187, the system status indicator lights will change from green, to yellow, to red. The following indicators will change in color as warnings to the driver escalate:

- Active Driving Assist Indicator (steering wheel icon in the instrument cluster display or Head Up Display [if equipped])
- Glow effect of the instrument cluster display

Active Driving Assist Indicators Are Off (Indicator Light Is Off)

- ADA is not turned on/enabled by the driver.

Active Driving Assist Indicators Are White (Indicator Light Is Off)

- ADA is turned on/enabled by the driver, but the system is not actively steering and providing speed control for the vehicle.

Active Driving Assist Indicators Are Green (Green Indicator Light — Hands-Free Mode Only)

- System is actively steering and providing speed control for the vehicle and the system detects driver is attentive.

Active Driving Assist Indicators Are Yellow

- Driver inattentiveness has been detected, warning the driver to place hands on the steering wheel, or look back toward the road (if equipped with the Hands-Free system).

Active Driving Assist Indicators Are Red

- Driver inattentiveness is still being detected, or driver take-over is being requested. The driver must return their hands to the wheel. Upon driver take-over request, the driver must return their hands to the wheel, eyes to the road and (if requested) press the accelerator or brake pedal.

NOTE:

For both Base ADA and Hands-Free ADA, the driver **MUST** replace hands on the steering wheel and take control of the vehicle when the system is deactivated.

SYSTEM STATUS

Along with changes in the system's indicator lights (green, yellow, and red), the system can also issue several accompanying warnings intended to provide the driver with enough time to react, avoid or mitigate a potential collision.

Hands-Free Active Driving Assist System

A seat vibration warning will occur (yellow or red warning light is issued).

The driver can take control of the vehicle at anytime to override the warnings by pressing the gas or brake pedal, moving the steering wheel, and being attentive to the road.

SYSTEM OPERATION/LIMITATIONS

WARNING!

Active Driving Assist is an SAE Level 2 Driver Assist feature, requiring driver attention at all times. To prevent serious injury or death:

- Always remember that the Active Driving Assist system is a convenience system that cannot accurately detect all situations. Complete attention is always required while driving, even when using the Active Driving Assist system.
- Always remain alert and be ready to take control of the vehicle in the event that the Active Driving Assist system deactivates, or otherwise lacks full functionality as described further before and after this statement.

(Continued)

WARNING!

- Always keep your eyes on the road and hands on the steering wheel when the Base Active Driving Assist system is activated.
- Always keep your eyes on the road when the Hands-Free Active Driving Assist system is activated.
- Maintain a safe distance from other vehicles and pay attention to traffic conditions.
- Do not use a hand held device when either Base, or Hands-Free Active Driving Assist system is engaged.
- Always pay attention to the road when the Hands-Free Active Driving Assist system is engaged. The Active Driving Assist system will not steer to avoid safety hazards, construction zones, objects, or road impediments. You need to take control to steer and brake the vehicle in such situations, and when merging into traffic, exiting the highway, making a turn for crossing traffic, or stopping for traffic control devices.
- Do not place any objects on the steering wheel (e.g. steering wheel covers) which could interfere with the hand detection sensors.

The Hands-Free Active Driving Assist system **DOES NOT**:

- Warn or prevent collisions with other vehicles
- Steer your vehicle around stopped vehicles, slower vehicles, construction zones or equipment, pedestrians, or animals
- Respond to traffic lights or stop signs

- Merge onto highways or exit off ramps
- Change lanes in Hands-On mode
- React to cross traffic

NOTE:

Adaptive Cruise Control (ACC) is a core component of ADA. For ACC system limitations → page 166 .

The Active Driving Assist system may have limited or reduced functionality when one of the following conditions occur:

- The vehicle's radar sensors and/or forward facing camera is damaged, covered, misaligned, or obstructed (e.g. by mud, ice, snow, etc.)
- If the suspension alignment is not correct, if the vehicle is modified (e.g. lifting or lowering the suspension, installing different sized wheels or tires) or if there has been damage due to road hazards
- Driving near highway toll booths

NOTE:

If damage to the windshield occurs, have the windshield replaced by an authorized dealer as soon as possible.

ACTIVE LANE MANAGEMENT SYSTEM — IF EQUIPPED

ACTIVE LANE MANAGEMENT OPERATION

The Active Lane Management (ALM) system uses a forward facing camera to detect lane markings or road edges and to measure vehicle position within the lane

boundaries. If equipped with Blind Spot Monitoring (BSM) it uses sensors to detect vehicles in adjacent lanes while the driver is preparing to change lanes.

The system is operational at speeds above 37 mph (60 km/h) and below 112 mph (180 km/h).

When both lane markings are detected, and the vehicle approaches (or crosses) the lane marking with no turn signal applied, and the blind spot zone is not occupied, the ALM system provides warnings to prompt the driver to remain within the lane boundaries. These warnings include a visual warning in the instrument cluster along with steering assist torque (if configured in Uconnect Settings).

If the driver crosses the lane marking, the system will either guide the vehicle back to the center of the lane, provide a vibration in the steering wheel, or both, depending on radio settings.

When both lane markings are detected, and the driver uses the turn signal to indicate a lane change, and a vehicle is detected in the BSM zone on that side of the vehicle, the ALM system provides a warning in the form of steering assist and/or steering vibration (depending on radio settings) to guide the vehicle back to the center of the lane.

NOTE:

- The system will suppress visual warnings, steering vibration (if selected in radio settings), and steering assistance (if selected in radio settings) when the driver activates the turn signal, the blind spot zone is clear of vehicles, and a lane change is occurring.
- If the Blind Spot Monitoring (BSM) system detects a vehicle in the adjacent lane, and the turn signal is applied in that direction, the BSM LED on the mirror

will flash. If the driver continues to attempt the lane change, steering wheel torque will be provided to keep the vehicle within its lane markings.

The driver may manually override the steering assist warning by applying force to the steering wheel at any time.

When only a single lane marking is detected and the driver drifts across the lane marking (no turn signal applied), the Active Lane Management system provides a visual warning in the instrument cluster, as well as a steering assist torque (if configured in Uconnect Settings), to prompt the driver to remain within the lane boundaries. If the driver continues to drift out of the lane, the system provides a flashing visual warning through the instrument cluster display as well as a haptic steering wheel vibration (if configured in Uconnect Settings) when the vehicle crosses the lane boundary.

NOTE:

When operating conditions have been met, the Active Lane Management system will monitor if the driver's hands are on the steering wheel and provides an audible and visual warning to the driver if removed. The system will cancel if the driver does not return their hands to the wheel.

TURNING ACTIVE LANE MANAGEMENT ON OR OFF



The Active Lane Management button can be located above or to the right of the Uconnect display.

To turn the system on, push the Active Lane Management button (LED turns off). A message is shown in the instrument cluster display.

To turn the system off, push the button again (LED turns on).

NOTE:

The Active Lane Management system will retain the last system state on or off from the last ignition cycle when the ignition is placed in the ON/RUN position.

ACTIVE LANE MANAGEMENT WARNING MESSAGE

The Active Lane Management system will indicate the current lane drift condition through the instrument cluster display.

When the system is on, the lane lines are gray.

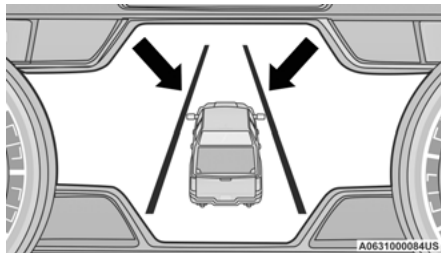

System On (Gray Lines)

Left Lane Departure — Only Left Lane Detected

- When the system is on and only the left lane marking has been detected, and the system is ready to provide visual warnings in the instrument cluster display and a vibration and/or steering assist warning in the steering wheel if a lane departure occurs.
- When the system senses the lane line has been approached (but not crossed), the left lane line will change to solid yellow and the system will provide steering assist torque (if programmed in Uconnect Settings).
- When the system senses the lane line is being crossed, the left lane line will change to flashing yellow, and the system will provide haptic steering wheel vibration (if programmed in Uconnect Settings).

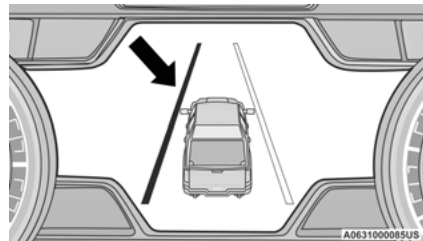

Lane Crossed (Flashing Yellow Line)

NOTE:

The Active Lane Management system operates with similar behavior for a right lane departure when only the right lane marking has been detected.

Left Lane Departure – Both Lanes Detected

- When both lane markings have been detected, the system is ready to provide visual warnings in the instrument cluster display and a vibration and/or steering assist warning in the steering wheel if a lane departure occurs.

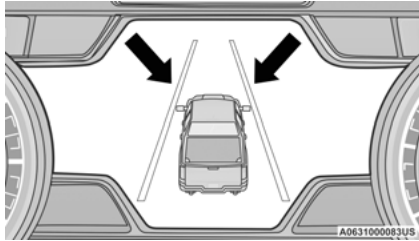

System On (Gray Lines)

- When the system senses a lane drift situation, the left lane line turns solid yellow. At this time, steering assist warning is applied to the steering wheel in the opposite direction of the lane boundary.

For example: If approaching the left side of the lane the steering wheel will turn to the right.

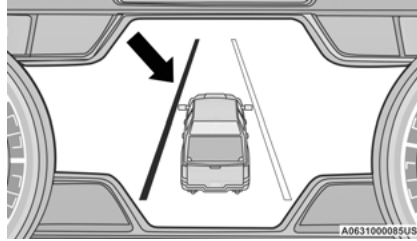

Lane Drift (Solid Yellow Line)

- When the system senses the lane line is being crossed, the left lane line changes from solid yellow to flashing yellow (on/off). At this time, vibration is applied to the steering wheel.

For example: If approaching the left side of the lane the steering wheel will turn to the right.

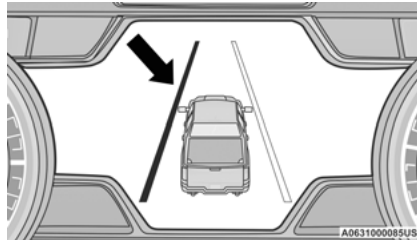

Lane Crossed (Flashing Yellow Line)

NOTE:

- The Active Lane Management system operates with similar behavior for a right lane departure.

- If the turn signal is activated, and the vehicle begins to depart the lane at the same time the Blind Spot Monitoring (BSM) system detects another vehicle in the BSM zones, the system will provide haptic steering wheel vibration and/or steering assist torque (if programmed in Uconnect Settings).

CHANGING ACTIVE LANE MANAGEMENT STATUS

Configurable settings for the Active Lane Management system are available within the Uconnect system.

Selectable Warning Types:

- Vibration Only
- Steering Assist Only
- Vibration And Steering Assist

Other configurable settings for this system are for the intensity of the vibration (high/med/low), steering assist strength (hi/med/low), and the warning zone sensitivity (early/medium/late).

NOTE:

- The system will not apply vibration and/or steering assist to the steering wheel whenever a safety system engages (Anti-Lock Brakes, Traction Control System, Electronic Stability Control, Forward Collision Warning, etc.).
- The Blind Spot Monitoring system will be forced on when the ALM system is enabled.
- The ALM system will be suppressed when the Active Driving Assist system (if equipped) is engaged.

PARKVIEW REAR BACK UP CAMERA — IF EQUIPPED

The ParkView Rear Back Up Camera allows you to see an on-screen image of the rear surroundings of your vehicle whenever the gear selector is put into REVERSE. The image will be displayed on the Navigation/Multimedia radio display screen along with a caution note to “Check Entire Surroundings” across the top of the screen. After five seconds this note will disappear. The ParkView Camera is located in the center of the tailgate handle.

NOTE:

Removing the tailgate will disable the Rear View Camera function.

Manual Activation Of The Rear View Camera:

1. Press the Vehicle button located on the bottom of the Uconnect display and then select the Camera menu.
2. Press the Back Up Camera icon to turn the Rear View Camera system on.

NOTE:

- The Rear View camera can also be turned on manually through the Apps menu within the Uconnect system.
- The ParkView Rear Back Up Camera has programmable modes of operation that may be selected through the Uconnect system → page 227.

When the vehicle is shifted out of REVERSE with camera delay turned off, the rear camera mode is

exited and the previous screen appears. When the vehicle is shifted out of REVERSE with camera delay turned on, the camera image will continue to be displayed for up to 10 seconds after shifting out of REVERSE unless the following conditions occur: The vehicle speed exceeds 8 mph (13 km/h), the vehicle is shifted into PARK, the vehicle's ignition is placed in the OFF position, or the user presses the touchscreen X button to exit out of the camera video display.

Whenever the Rear View Camera image is activated through the Back Up Camera button in the Camera menu, and the vehicle speed is greater than, or equal to, 8 mph (13 km/h), a display timer for the image is initiated. The image will continue to be displayed until the display timer exceeds 10 seconds.

NOTE:

- If the vehicle speed remains below 8 mph (13 km/h), the Rear View Camera image will be displayed continuously until deactivated via the touchscreen X button, the transmission is shifted into PARK, or the ignition is placed in the OFF position.
- The touchscreen X button to disable the camera image is made available ONLY when the vehicle is not in REVERSE.

When enabled, active guidelines are overlaid on the image to illustrate the width of the vehicle and its projected back up path based on the steering wheel position. A dashed centerline overlay indicates the center of the vehicle to assist with parking or aligning to a hitch/receiver. Different colored zones indicate the distance to the rear of the vehicle. The following table shows the approximate distances for each zone:

Zones	Distance To The Rear Of The Vehicle
Red	0 - 1 ft (0 - 30 cm)
Yellow	1 ft - 6.5 ft (30 cm - 2 m)
Green	6.5 ft or greater (2 m or greater)

WARNING!

Drivers must be careful when backing up even when using the ParkView Rear Back Up Camera. Always check carefully behind your vehicle, and be sure to check for pedestrians, animals, other vehicles, obstructions, or blind spots before backing up. You are responsible for the safety of your surroundings and must continue to pay attention while backing up. Failure to do so can result in serious injury or death.

CAUTION!

- To avoid vehicle damage, ParkView should only be used as a parking aid. The ParkView camera is unable to view every obstacle or object in your drive path.
- To avoid vehicle damage, the vehicle must be driven slowly when using ParkView to be able to stop in time when an obstacle is seen. It is recommended that the driver look frequently over his/her shoulder when using ParkView.

NOTE:

If snow, ice, mud, or any foreign substance builds up on the camera lens, clean the lens, rinse with water, and dry with a soft cloth. Do not cover the lens.

Zoom View

When the Rear View Camera image is being displayed, and the vehicle speed is below 8 mph (13 km/h) while in any gear, Zoom View is available. By pressing the “magnifying glass” icon in the upper left of the display screen, the image will zoom in to four times the standard view. Pressing the icon a second time will return the view to the standard Back Up Camera display.

When Zoom View is selected while the vehicle is in REVERSE, then shifted to DRIVE, the camera delay view will display the standard Back Up Camera view. If the vehicle is then returned to REVERSE gear from DRIVE, the Zoom View selection will automatically resume.

NOTE:

The Zoom View button and AUX button (if equipped) will not be available when the vehicle is shifted into REVERSE and the Trailer Reverse Steering Control (TRSC) feature (if equipped) is activated.

Shifting to NEUTRAL from any gear will maintain the selected view (Zoom or Standard) as long as the vehicle is below 8 mph (13 km/h).

If the vehicle is in PARK, Zoom View is available until the gear selector is placed in DRIVE or REVERSE and speeds are at or above 8 mph (13 km/h).

NOTE:

- If the vehicle is in DRIVE, NEUTRAL, or REVERSE, and speed is greater than or equal to 8 mph (13 km/h),

Zoom View is unavailable and the icon will appear grey.

- While in Zoom View, the guidelines will not be visible.

For information on Auxiliary Cameras (if equipped), see  page 204.

SURROUND VIEW CAMERA SYSTEM — IF EQUIPPED

The Surround View Camera system allows you to see an on-screen image of the surroundings and the Top View of your vehicle. This occurs whenever the gear selector is in REVERSE or when enabled through the Uconnect system. The Top View of the vehicle will also show if any doors are open. The image will be displayed on the touchscreen along with a caution note “Check Entire Surroundings”. After five seconds, this note will disappear. The Surround View Camera system is comprised of four cameras located in the front grille, rear tailgate and side mirrors.

NOTE:

- Removing the tailgate will disable the Rear View Camera function.
- The Surround View Camera system has programmable settings that may be selected through the Uconnect system  page 227.



Press this button on the touchscreen to enter the Surround View Camera menu in the Uconnect system.

When the vehicle is shifted into REVERSE, the Rear View and Top View is the default view of the system.

If the camera delay is turned on, the camera image will display for up to 10 seconds after shifting out of REVERSE. The camera image will stop displaying, close, and display the previous screen if the vehicle speed exceeds 8 mph (13 km/h), the vehicle is shifted into PARK, or the ignition is placed in the OFF position. The touchscreen X button on the touchscreen disables the display of the camera image.

If the camera delay is turned off, the camera image will close and display the previous screen after shifting out of REVERSE.

If active guidelines are enabled, the lines are overlaid on the image in the Rear View and Top View to illustrate the width of the vehicle and its projected path based on steering wheel position.

The guidelines have different colored zones to indicate the distance an object in the view is from the rear of the vehicle. Refer to the following chart:

Zone	Distance To The Rear Of The Vehicle
Red	0 - 1 ft (0 - 30 cm)
Yellow	1 ft - 6.5 ft (30 cm - 2 m)
Green	6.5 ft or greater (2 m or greater)

Modes Of Operation

Standard Rear View can be manually activated by selecting “Back Up Camera” through the Camera menu within the Uconnect system.

Top View

The Top View will show in the Uconnect system with Rear View or Front View in a split screen display. There are integrated ParkSense arcs in the image at the front and rear of the vehicle. The arcs will change color from yellow to red corresponding the distance zones to the oncoming object.

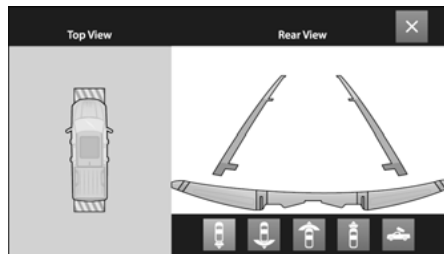

Surround View Camera View

NOTE:

- Front tires will be seen in the image when the tires are turned.
- Due to wide angle cameras in the mirrors, the image will appear distorted.
- The Top View will show which doors are open.
- Open front doors will block the outside image.

Top View Plus Rear View



This is the default view of the system in REVERSE and is always paired with the Top View of the vehicle with optional active guidelines for the projected path when enabled.

Rear Cross Path View



Pressing the Rear Cross Path button will give the driver a wider angle view of the rear camera system. The Top View will be disabled when this is selected.

Top View Plus Front View



Pressing the Front View button will show you what is immediately in front of the vehicle and is always paired with the Top View of the vehicle.

Front Cross Path View



Pressing the Front Cross Path button will give the driver a wider angle view of the front camera system. The Top View will be disabled when this is selected.

Back Up Camera View



Pressing the Back Up Camera button will provide a full screen rearview with the ability to access a Zoom View.

NOTE:

- If the Back Up Camera was selected through the Surround View Camera menu, exiting out of screen display will return to the Surround View menu. If the Back Up Camera was manually activated through the Camera menu of the Uconnect system, exiting out of the display screen will return to the Camera menu.
- When the Trailer Reverse Steering Control (TRSC) feature (if equipped) is activated, the following buttons on the touchscreen will be unavailable:
 - Back Up Camera
 - Front Facing Camera with Tire Lines
 - All Surround View Camera Views

Zoom View

When the Rear View Camera image is being displayed, and the vehicle speed is below 8 mph (13 km/h), Zoom View is available. By pressing the “magnifying glass” icon in the upper left of the display screen, the image will zoom in two times the standard view. Pressing the icon a second time will return the view to the standard Back Up Camera display.

When Zoom View is selected while the vehicle is in REVERSE, then shifted to DRIVE, the camera delay view will display the standard Back Up Camera view. If the vehicle is then returned to REVERSE gear from DRIVE, the Zoom View selection will automatically resume.

Shifting to NEUTRAL from any gear will maintain the selected view (Zoom or Standard) as long as the vehicle is below 8 mph (13 km/h).

If the vehicle is in PARK, Zoom View is available until the gear selector is placed in DRIVE or REVERSE and speeds are at or above 8 mph (13 km/h).

NOTE:

- If the vehicle is in DRIVE, NEUTRAL, or REVERSE, and speed is greater than or equal to 8 mph (13 km/h), Zoom View is unavailable and the icon will appear grey.
- While in Zoom View, the guidelines will not be visible.

Deactivation

The system is deactivated in the following conditions if it was activated **automatically**:

- When the vehicle is shifted out of REVERSE with camera delay turned on, the camera image will continue to be displayed for up to 10 seconds after shifting out of REVERSE unless the vehicle speed exceeds 8 mph (13 km/h), the vehicle is shifted into PARK or the ignition is placed in the OFF position. There is a touchscreen X button to disable the display of the camera image.
- When the vehicle is shifted out of REVERSE with camera delay turned off, the Surround View Camera mode is exited and the last known screen appears again.

The system is deactivated in the following conditions if it was activated **manually** from the Uconnect Camera menu via Surround View button or Back Up Camera button:

- The touchscreen X button is pressed
- Vehicle is shifted into PARK
- Ignition is placed in the OFF position
- Vehicle speed is over 8 mph (13 km/h) for 10 seconds

NOTE:

If the Surround View Camera is activated manually, and the vehicle is shifted into REVERSE, deactivation methods for automatic activation are assumed.

The camera delay system is turned off manually through the Uconnect settings menu ➡ page 227.

NOTE:

- If snow, ice, mud, or any foreign substance builds up on the camera lenses, clean the lenses, rinse with water, and dry with a soft cloth. Do not cover the lenses.
- If a malfunction with the system has occurred, see an authorized dealer.

WARNING!

Drivers must be careful when backing up even when using the Surround View Camera. Always check carefully behind your vehicle, and be sure to check for pedestrians, animals, other vehicles, obstructions, or blind spots before backing up. You are responsible for the safety of your surroundings and must continue to pay attention while backing up. Failure to do so can result in serious injury or death.

CAUTION!

- To avoid vehicle damage, Surround View should only be used as a parking aid. The Surround View camera is unable to view every obstacle or object in your drive path.

(Continued)

CAUTION!

- To avoid vehicle damage, the vehicle must be driven slowly when using Surround View to be able to stop in time when an obstacle is seen. It is recommended that the driver look frequently over his/her shoulder when using Surround View.

For information on Auxiliary Cameras (if equipped), see ➡ page 204.

FORWARD FACING CAMERA WITH TIRE LINES — IF EQUIPPED

4

The Forward Facing Camera displays a front view image of the road ahead, along with tire lines to guide the driver when driving on narrow roads. Tire lines can be activated/deactivated through the Uconnect Settings.

Activation

The Forward Facing Camera can be activated in the following ways:

- Pressing the Forward Facing Camera button in the Camera screen or Apps menu
- Pressing the Forward Facing Camera button located in the upper left corner of the Back Up camera display

Once activated, the camera image will remain on as long as the vehicle speed is below 8 mph (13 km/h).

Deactivation

The Forward Facing Camera is deactivated in the following conditions:

- The vehicle exceeds 8 mph (13 km/h), except when vehicle is in 4WD Low.
- The touchscreen X button is pressed.
- The vehicle is shifted into PARK.
- The ignition is placed in the OFF position.

NOTE:

If the vehicle is in 4WD Low, the Forward Facing Camera image will be displayed until the touchscreen X button is pressed or the ignition is placed in the OFF position.

TURN SIGNAL ACTIVATED BLIND SPOT ASSIST — IF EQUIPPED

When enabled in the Uconnect system and a turn signal is activated, the corresponding side view mirror camera will display in the radio. The camera will continue to display as long as the turn signal is engaged. If "Only With Trailer" is selected (if equipped), the camera will only display when a trailer is connected to the vehicle  page 227.

WARNING!

Blind Spot Assist is only an aid to help detect objects in the blind spot zones and may not provide alerts when changing lanes under all driving conditions. Even if your vehicle is equipped with the BSA system,

(Continued)

WARNING!

always check your vehicle's mirrors, glance over your shoulder, and use turn signals before changing lanes. Failure to do so can result in serious injury or death.

TRAILER CAMERAS — IF EQUIPPED

AUX CAMERA — IF EQUIPPED

Your vehicle may be equipped with one or two AUX Cameras, which display rearview and side view images from the trailer on the touchscreen.

NOTE:

Two Aux Cameras are only available on vehicles with NAV equipped radios if the vehicle is not equipped with a Center High Mounted Stop Lamp (CHMSL) and Surround View Camera system.

Activation

The AUX Camera is activated by first pressing the Back Up Camera or Cargo Camera (if equipped) button on the touchscreen, followed by the AUX button located in the upper left corner of the rearview display. On vehicles with Surround View Camera (if equipped), the AUX Camera can be activated when the vehicle is in REVERSE by first pressing the More Cams button in the Surround View screen, followed by the AUX tab. The AUX camera can also be activated when the vehicle is in REVERSE by pressing the AUX button.

If equipped with two AUX Cameras, you can switch between each camera by pressing the AUX 1 or AUX 2 buttons on the Trailer Camera display.



AUX 1 Camera Button



AUX 2 Camera Button

Deactivation

The AUX Camera is deactivated by pressing the touchscreen X button. This will return the display back to the previously displayed screen.

NOTE:

- If the AUX button is pressed and no AUX Camera is connected, the touchscreen will display a blue screen along with the message "Camera System Unavailable." The screen can be exited out by pressing the touchscreen X button. This will return the display back to the previously displayed screen.
- Zoom View is not available with the AUX Camera feature.
- The display will always default to the Trailer Camera display AUX 1.

REFUELING THE VEHICLE

The capless fuel filler is located on the left side of the vehicle.

The capless system is sealed by two flapper doors.

WARNING!

- Never have any smoking materials lit in or near the vehicle when the fuel door is open or the tank is being filled.
- Never add fuel when the engine is running. This is in violation of most state and federal fire regulations and may cause the MIL to turn on.
- A fire may result if gasoline is pumped into a portable container that is inside of a vehicle. You could be burned. Always place gas containers on the ground while filling.

CAUTION!

To avoid fuel spillage and overfilling, do not “top off” the fuel tank after filling.

1. Put the vehicle in PARK and switch the ignition off.
2. Push the center-rear edge of the fuel filler door (3 o'clock position) and release to open.

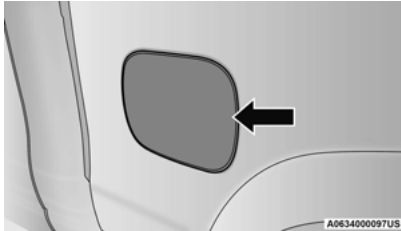
**Fuel Filler Door**

3. Insert the fuel nozzle fully into the filler pipe, the nozzle opens and holds both flapper doors while refueling.

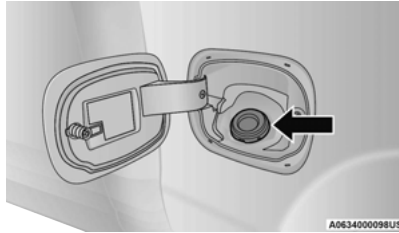
**Fuel Filler**

4. When the fuel nozzle “clicks” or shuts off, the fuel tank is full.
5. Keep the nozzle in the filler for five seconds after nozzle clicks to allow fuel to drain from the nozzle.
6. Remove the fuel filler nozzle.
7. To close the fuel filler door, push the center-rear edge (3 o'clock position) of the fuel filler door and then release. The fuel filler door will latch closed.

NOTE:

In certain cold conditions, ice may prevent the fuel filler door from opening. If this occurs, lightly push on the fuel filler door around the perimeter to break the ice buildup.

WARNING!

Static electricity can cause an ignition of flammable liquid, vapor or gas in any vehicle or trailer. To reduce risk of serious injury or death when filling containers:

- Always place container on the ground before filling.
- Keep the pump nozzle in contact with the container when you are filling it.
- Use only approved containers for flammable liquid.
- Do not leave container unattended while filling.
- A static electric charge could cause a spark and fire hazard.

VEHICLE LOADING**CERTIFICATION LABEL**

As required by National Highway Traffic Safety Administration regulations, your vehicle has a certification label affixed to the driver's side door or B-pillar.

This label contains the month and year of manufacture, Gross Vehicle Weight Rating (GVWR), front and rear Gross Axle Weight Rating (GAWR), and Vehicle Identification Number (VIN). A Month-Day-Hour (MDH) number is included on this label and indicates the Month, Day and Hour of manufacture. The bar code that appears on the bottom of the label is your VIN.

Gross Vehicle Weight Rating (GVWR)

The GVWR is the total permissible weight of your vehicle including driver, passengers, vehicle, options and cargo. The label also specifies maximum capacities of front and rear GAWR. Total load must be limited so GVWR and front and rear GAWR are not exceeded.

Payload

The payload of a vehicle is defined as the allowable load weight a truck can carry, including the weight of the driver, all passengers, options and cargo.

Gross Axle Weight Rating (GAWR)

The GAWR is the maximum permissible load on the front and rear axles. The load must be distributed in the cargo area so that the GAWR of each axle is not exceeded.

Each axle GAWR is determined by the components in the system with the lowest load carrying capacity (axle, springs, tires or wheels). Heavier axles, or suspension components sometimes specified by purchasers for increased durability, do not necessarily increase the vehicle's GVWR.

Tire Size

The tire size on the Vehicle Certification Label represents the actual tire size on your vehicle. Replacement tires must be equal to the load capacity of this tire size.

Rim Size

This is the rim size that is appropriate for the tire size listed.

Inflation Pressure

This is the cold tire inflation pressure for your vehicle for all loading conditions up to full Gross Axle Weight Rating (GAWR).

Curb Weight

The curb weight of a vehicle is defined as the total weight of the vehicle with all fluids at full capacity conditions, and with no occupants or cargo loaded into the vehicle. The front and rear curb weight values are determined by weighing your vehicle on a commercial scale before any occupants or cargo are added.

Loading

The actual total weight and the weight of the front and rear of your vehicle at the ground can best be determined by weighing it when it is loaded and ready for operation.

The entire vehicle should first be weighed on a commercial scale to ensure that the Gross Vehicle Weight Rating (GVWR) has not been exceeded. The weight on the front and rear of the vehicle should then be determined separately to be sure that the load is properly distributed over the front and rear axle. Weighing the vehicle may show that the Gross Axle Weight Rating (GAWR) of either the front or rear axles has been exceeded but the total load is within the specified GVWR. If so, weight must be shifted from front to rear or rear to front as appropriate until the specified weight limitations are met. Store the heavier items down low and be sure that the weight is distributed equally. Stow all loose items securely before driving.

Improper weight distributions can have an adverse affect on the way your vehicle steers and handles and the way the brakes operate.

WARNING!

Do not load your vehicle any heavier than the GVWR, maximum Payload or the maximum front and rear GAWR. If you do, parts on your vehicle can break, or it can change the way your vehicle handles. This could cause you to lose control. Overloading can shorten the life of your vehicle.

TRAILER TOWING

In this section you will find safety tips and information on limits to the type of towing you can reasonably do with your vehicle. Before towing a trailer, carefully review this information to tow your load as efficiently and safely as possible.

To maintain the New Vehicle Limited Warranty coverage, follow the requirements and recommendations in this manual concerning vehicles used for trailer towing.

COMMON TOWING DEFINITIONS

The following trailer towing related definitions will assist you in understanding the following information:

Gross Vehicle Weight Rating (GVWR)

The GVWR is the total allowable weight of your vehicle. This includes driver, passengers, cargo and tongue weight. The total load must be limited so that you do not exceed the GVWR ➞ page 205.

Gross Trailer Weight (GTW)

The GTW is the weight of the trailer plus the weight of all cargo, consumables and equipment (permanent or temporary) loaded in or on the trailer in its "loaded and ready for operation" condition.

The recommended way to measure GTW is to put your fully loaded trailer on a vehicle scale. The entire weight of the trailer must be supported by the scale

Gross Combination Weight Rating (GCWR)

The GCWR is the total allowable weight of your vehicle and trailer when weighed in combination.

Gross Axle Weight Rating (GAWR)

The GAWR is the maximum capacity of the front and rear axles. Distribute the load over the front and rear axles evenly. Make sure that you do not exceed either front or rear GAWR → page 205.

WARNING!

It is important that you do not exceed the maximum front or rear GAWR. A dangerous driving condition can result if either rating is exceeded. You could lose control of the vehicle and have a collision.

Tongue Weight (TW)

The Tongue Weight is the downward force exerted on the hitch ball by the trailer. You must consider this as part of the load on your vehicle.

Trailer Frontal Area

The trailer frontal area is the maximum height multiplied by the maximum width of the front of a trailer.

Trailer Sway Control (TSC)

The TSC can be a mechanical telescoping link that can be installed between the hitch receiver and the trailer tongue that typically provides adjustable friction associated with the telescoping motion to dampen any unwanted trailer swaying motions while traveling.

The electronic TSC (if equipped) recognizes a swaying trailer and automatically applies individual wheel brakes and/or reduces engine power to attempt to eliminate the trailer sway.

Weight-Carrying Hitch

A weight-carrying hitch supports the trailer TW, just as if it were luggage located at a hitch ball or some other connecting point of the vehicle. These kinds of hitches are commonly used to tow small and medium-sized trailers.

Weight-Distributing Hitch

A Weight-Distributing system works by applying leverage through spring (load) bars. They are typically used for heavier loads to distribute trailer tongue weight to the tow vehicle's front axle and the trailer axle(s). When used in accordance with the manufacturer's directions, it provides for a more level ride, offering more consistent steering and brake control thereby enhancing towing safety. The addition of a friction/hydraulic sway control also dampens sway caused

by traffic and crosswinds and contributes positively to tow vehicle and trailer stability. TSC and a weight-distributing (load equalizing) hitch are recommended for heavier TW and may be required depending on vehicle and trailer configuration/loading to comply with GAWR requirements.

WARNING!

- An improperly adjusted weight-distributing hitch system may reduce handling, stability and braking performance and could result in a collision.
- Weight-distributing systems may not be compatible with surge brake couplers. Consult with your hitch and trailer manufacturer or a reputable Recreational Vehicle dealer for additional information.

4



A0636000055US

Without Weight-Distributing Hitch (Incorrect)

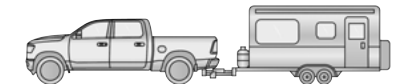

A0636000052US

With Weight-Distributing Hitch (Correct)

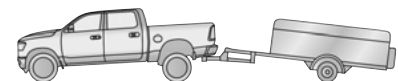

A0636000053US

Improper Adjustment Of Weight-Distributing Hitch (Incorrect)

RECOMMENDED DISTRIBUTION HITCH ADJUSTMENT

Towing With Air Suspension — If Equipped

1. Verify that the vehicle is at the normal ride height.

NOTE:

The vehicle must remain in the engine run position with all doors closed while attaching a trailer for proper leveling of the air suspension system.

2. Position the truck to be ready to connect to the trailer (do not connect the trailer).
3. Enable tire jack mode through the instrument cluster or touchscreen radio settings. Tire jack mode will be canceled and the procedure must be restarted if the vehicle is driven at speeds above 5 mph (8 km/h).
4. Measure the height from the top of the front wheel opening on the fender to ground; this is height H1.



A0636000054US

Measuring Height (H)

5. Attach the trailer to the vehicle without the weight-distributing bars connected.
6. Measure the height from the top of the front wheel opening on the fender to the ground; this is height H2.
7. Install and adjust the tension in the weight-distributing bars per the manufacturer's recommendations so that the height of the front

fender is approximately $(H2-H1)/3+H1$ (about 1/3 the difference between H2 and H1 above normal ride height [H1]).

8. Use the instrument cluster or touchscreen radio settings and switch off tire jack mode. Make sure the truck returns to normal ride height. Perform a visual inspection of the trailer and weight-distributing hitch to confirm the manufacturer's recommendations have been met.
9. The truck can now be driven.

Measurement Example	Example Height (mm)
H1	925
H2	946
H2-H1	21
$(H2-H1)/3$	7
$(H2-H1)/3 + H1$	932

NOTE:

For all towing conditions, we recommend towing with Tow/Haul mode engaged.

TRAILER HITCH TYPE AND MAXIMUM TRAILER WEIGHT

The following chart provides the maximum trailer weight a given factory equipped trailer hitch type can tow and should be used to assist you in selecting the correct trailer hitch for your intended towing condition.

Trailer Hitch Type and Maximum Trailer Weight	
Hitch Type	Max. Trailer Weight / Max. Tongue Weight
Class IV - 1500 Model	12,750 lb (5,783 kg) / 1,275 lb (578 kg)
Refer to the "Trailer Towing Weights (Maximum Trailer Weight Ratings)" for the Maximum Gross Trailer Weight (GTW) towable for your given drivetrain.	

All trailer hitches should be professionally installed on your vehicle.

NOTE:

Be careful not to scratch the bumper step pad.

TRAILER TOWING WEIGHTS (MAXIMUM TRAILER WEIGHT RATINGS)

NOTE:

For trailer towing information (maximum trailer weight ratings) refer to the following website addresses:

- ramtrucks.com/towing/towing-guide
- ramtruck.ca (Canada)

TRAILER AND TONGUE WEIGHT

Never exceed the maximum tongue weight stamped on your fascia/bumper or trailer hitch.

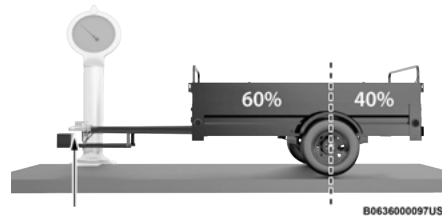

Weight Distribution

CAUTION!

Always load a trailer with 60% of the weight in the front of the trailer. This places 10% of the GTW on the tow hitch of your vehicle. Loads balanced over the wheels or heavier in the rear can cause the trailer to sway severely side to side which will cause loss of control of the vehicle and trailer. Failure to load trailers heavier in front is the cause of many trailer collisions.

Consider the following items when computing the weight on the rear axle of the vehicle:

- The TW of the trailer.
- The weight of any other type of cargo or equipment put in or on your vehicle.
- The weight of the driver and all passengers.

NOTE:

Remember that everything put into or on the trailer adds to the load on your vehicle. Also, additional

factory-installed options or dealer-installed options must be considered as part of the total load on your vehicle. Refer to the Tire And Loading Information Placard for the maximum combined weight of occupants and cargo for your vehicle.

TRAILER HITCH ASSIST — IF EQUIPPED

Feature Overview

Trailer Hitch Assist (THA) is a feature that assists the driver with lining up the trailer hitch ball to the trailer coupler. Using the rear camera and sensors the vehicle will automatically steer the vehicle while the driver controls the braking.

Before beginning the operation check the following:

- Vehicle is at the most direct angle to the trailer coupler.
- There is enough lighting to allow the camera to locate the coupler.

Operation:

1. With your foot firmly on the brake pedal, place the vehicle in reverse.

- Press the trailer hitch icon located the upper right corner of the screen.

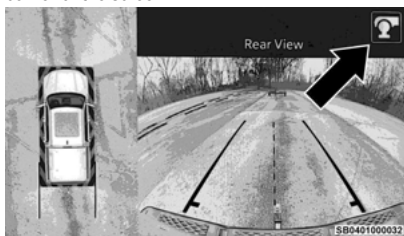

Trailer Hitch Icon

- Back up slowly towards the trailer until you see the trailer coupler has entered the target zone.

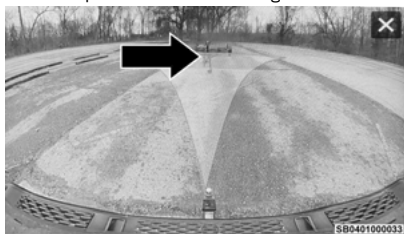

Trailer Entering Target Zone

- With the trailer coupler in the zone, press the coupler location on the touchscreen. The camera will zoom in on the coupler.

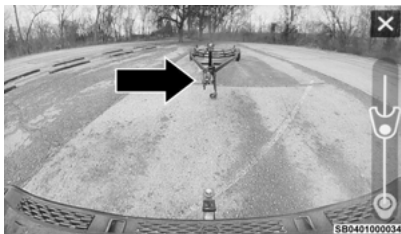

Coupler Location

- If the location is correct press CONFIRM or reselect the coupler location and press CONFIRM.
- After confirming the coupler location you will have to confirm that the coupler has enough clearance over the hitch. Press CONFIRM to continue.

NOTE:

If the coupler clearance is to low or it is unknown, shift the vehicle into PARK, raise the coupler, and resume procedure from Step 1.

- Press CONFIRM again that the coupler has clearance above the hitch.
- Press START and remove your hands from the steering wheel.
- Slowly release the brake and allow the vehicle to move towards the coupler. A green progress bar will appear on the right side of the screen to display the distance between the coupler (top) and the hitch ball (bottom).



Progress Bar (Start)

- Once the progress bar is lit completely fully apply the brake.



Progress Bar (End)

NOTE:

The Electric Park Brake (EPB) will be applied on this confirmation step.

- Once the brake is fully applied you can press CONFIRM that the trailer coupler has been reached.

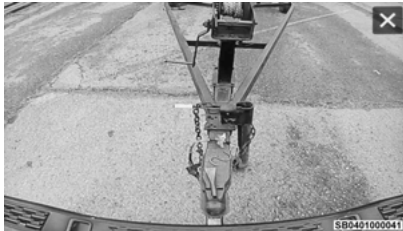

Coupler Has Been Reached

- Place the transmission in PARK and continue with the trailer connections.

TRAILER REVERSE STEERING CONTROL — IF EQUIPPED

Feature Overview

Trailer Reverse Steering Control (TRSC) is a feature that will assist the driver when backing up a trailer. By turning the knob located on the center stack, you can more accurately control the direction the trailer will go.

The driver controls the accelerator and the brake while steering with the use of the Trailer Reverse Steering Control knob. The trailer is steered according to the direction the knob is turned.

This feature will also allow the driver to back up a vehicle and trailer in a straight line when the knob is rested in its center position.

Minimal setup is required to use this feature.

Set Up:

To use the system, hitch your trailer to the truck and ensure all electrical wiring is connected.

The system will automatically calibrate an attached trailer during normal forward driving with no additional action needed from the driver. If the vehicle has not had enough time to automatically calibrate after connecting a trailer, you will see a “Calibrate Trailer” message in the instrument cluster when pressing the TRSC button to activate the system. If this is the case, perform the following maneuver to calibrate the trailer:

Drive forward at least 100 ft (30 m), perform a 90 degree turn and return to a straight position for at least another 100 ft (30 m). Perform another 90 degree turn, followed by another straight drive of at least 100 ft (30 m). Check that the system has calibrated by pushing the TRSC button.

NOTE:

The 90 degree turns could be in either the left or right direction.

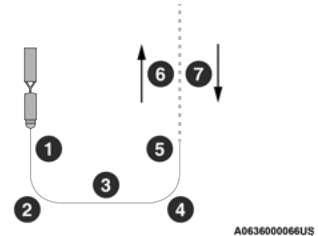

Trailer Reverse Steering Control Calibration

- Drive straight 100 ft (30 m). A “Calibrating Trailer” message will display when vehicle is in motion.
- Perform intersection turn with radius 50-65 ft (15-20 m) in either direction.
- Drive straight 100 ft (30 m).
- Perform intersection turn with radius 50-65 ft (15-20 m) in either direction.
- Drive straight 100 ft (30 m).
- Drive straight 100 ft (30 m), making sure to align vehicle/trailer to path center line.
- Once calibration is complete, feature will be available for use. For calibration runs under 30 mph (48 km/h) a “To Enable Trailer Steering Shift to P” message will appear to indicate calibration completion.

Using TRSC

CAUTION!

Always observe the position of the trailer and surroundings using the camera and mirrors to avoid damage to the truck or trailer.

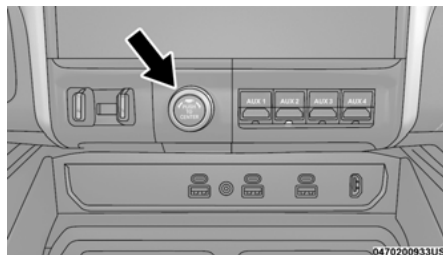
**Trailer Reverse Steering Control Knob**

To use the system, place the gear selector in PARK and put your foot on the brake. Push the activation button located above the TRSC knob in the center stack. The LED on the button will glow solid and the instrument cluster display will direct you to shift to REVERSE. Once in REVERSE the system is active. Remove hands from the steering wheel and slowly back up while turning the TRSC knob in the direction you want the trailer to go. Turning the knob clockwise will cause the trailer to turn right. Turning the knob counterclockwise will cause the trailer to turn left. If you release the knob, it will return to its center position, and the trailer will back up in a straight line.

Continue to control the accelerator and brake while backing the trailer up.

NOTE:

While active, TRSC will automatically disable the Rear Park Assist system if it was previously enabled.

The system will limit the top speed your vehicle can travel in REVERSE while using the feature. If needed, you can shift to DRIVE or NEUTRAL to pull forward to get more room or straighten out the trailer, and shift back to REVERSE without the need to reactivate the feature.

The feature will cancel after 30 seconds in DRIVE or when the vehicle speed reaches 8 mph (12 km/h).

To cancel out of the feature, come to a stop and shift to PARK, or push the TRSC activation button.

Instrument Cluster Messages:

- “Calibrate Trailer **עיר**” will display when a trailer is not calibrated and the vehicle is at a standstill while the button is pushed.
- “Calibrating Trailer” will display when the trailer is not calibrated and the vehicle is moving while the button is pushed.
- “To Activate Trailer Steering Shift To P” will display when the trailer is calibrated successfully, the TRSC activation button is pushed and the vehicle is not in PARK.
- “Trailer Steering Ready, Shift To Reverse” will display when the button is pushed, trailer is calibrated and the vehicle is in PARK.
- “Trailer Steering Active” will display after the driver shifts to REVERSE and indicates the feature is active.

- “Trailer Steering Unavailable” will display if there is a fault in the system preventing activation, the driver’s door is open, the driver’s seat belt is unbuckled, or the tailgate is open.

Other reasons the feature may cancel:

- The driver overrides steering by placing hands on the steering wheel.
- Trailer tracking is lost.
- If the trailer angle becomes excessive, the brakes apply bringing the vehicle to a stop and then applying the parking brake.
- Trailer steering button is pushed while active.
- Vehicle speed goes over 8 mph (12 km/h).
- Driver door is open and seat belt is unbuckled.
- Transmission shifted to PARK.

Trailer Memory

The trailer steering system will automatically retain the calibration of the previous five trailers connected, so recalibration will not be necessary when hooking up. The next time the vehicle is started, place the vehicle in DRIVE and drive a short distance. The TRSC system can then be activated.

NOTE:

Trailers may look different during day and night conditions. In such cases, the trailer may need to recalibrate.

Some trailers (such as boat trailers) will need to recalibrate while loaded and unloaded.

NOTE:

- The system may not detect a trailer in low light conditions. In sunny conditions, the performance may be degraded as shadows pass over the trailer.
- The driver is always responsible for safe operation of truck and trailer.
- The driver is always in control of the truck as well as the trailer and is responsible for controlling the throttle and brakes.
- The system may not function when the camera lens is blocked, blurred (covered with water, snow, ice, dirt, etc) and will not work unless the tailgate is upright and fully latched.

TOWING REQUIREMENTS

To promote proper break-in of your new vehicle drivetrain components, the following guidelines are recommended.

CAUTION!

- Do not tow a trailer at all during the first 500 miles (805 km) the new vehicle is driven. The engine, axle or other parts could be damaged.
- Then, during the first 500 miles (805 km) that a trailer is towed, do not drive over 50 mph (80 km/h) and do not make starts at full throttle. This helps the engine and other parts of the vehicle wear in at the heavier loads.

Perform the maintenance listed in the Scheduled Servicing section for the proper maintenance intervals  page 349. When towing a trailer, never exceed the GAWR or GCWR ratings.

WARNING!

Improper towing can lead to a collision. Follow these guidelines to make your trailer towing as safe as possible:

- Make certain that the load is secured in the trailer and will not shift during travel. When trailering cargo that is not fully secured, dynamic load shifts can occur that may be difficult for the driver to control. You could lose control of your vehicle and have a collision.
- When hauling cargo or towing a trailer, do not overload your vehicle or trailer. Overloading can cause a loss of control, poor performance or damage to brakes, axle, engine, transmission, steering, suspension, chassis structure or tires.
- Safety chains must always be used between your vehicle and trailer. Always connect the chains to the hook retainers of the vehicle hitch. Cross the chains under the trailer tongue and allow enough slack for turning corners.
- Vehicles with trailers should not be parked on a grade. When parking, apply the parking brake on the tow vehicle. Put the tow vehicle transmission in PARK. For four-wheel drive vehicles, make sure the transfer case is not in NEUTRAL. Always, block or "chock" the trailer wheels.
- GCWR must not be exceeded.
- **Total weight must be distributed between the tow vehicle and the trailer such that the following four ratings are not exceeded:**
 - GVWR

(Continued)

WARNING!

- GTW
- GAWR
- Tongue weight rating for the trailer hitch utilized

Towing Requirements — Tires

- Do not attempt to tow a trailer while using a compact spare tire.
- Do not drive more than 50 mph (80 km/h) when towing while using a full size spare tire.
- Proper tire inflation pressures are essential to the safe and satisfactory operation of your vehicle.
- Check the trailer tires for proper tire inflation pressures before trailer usage.
- Check for signs of tire wear or visible tire damage before towing a trailer.
- Replacing tires with a higher load carrying capacity will not increase the vehicle's GVWR and GAWR limits.
- For further information  page 391.

Towing Requirements — Trailer Brakes

- Do **not** interconnect the hydraulic brake system or vacuum system of your vehicle with that of the trailer.
- An electronically actuated trailer brake controller is required when towing a trailer with electronically actuated brakes. When towing a trailer equipped with a hydraulic surge actuated brake system, an electronic brake controller is not required.

- Trailer brakes are recommended for trailers over 1,000 lb (453 kg) and required for trailers in excess of 2,000 lb (907 kg).

WARNING!

- Do not connect trailer brakes to your vehicle's hydraulic brake lines. It can overload your brake system and cause it to fail. You might not have brakes when you need them and could have an accident.
- Towing any trailer will increase your stopping distance. When towing, you should allow for additional space between your vehicle and the vehicle in front of you. Failure to do so could result in an accident.

CAUTION!

If the trailer weighs more than 1,000 lb (453 kg) loaded, it should have its own brakes and they should be of adequate capacity. Failure to do this could lead to accelerated brake lining wear, higher brake pedal effort, and longer stopping distances.

Integrated Trailer Brake Module (ITBM) – If Equipped

Your vehicle may have an ITBM for electric and Electric Over Hydraulic (EOH) trailer brakes.

NOTE:

This module has been designed and verified with electric trailer brakes and new EOH systems. Some

previous EOH systems may not be compatible with ITBM.

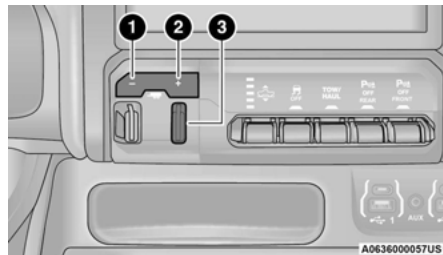

Integrated Trailer Brake Module (ITBM)

- 1 – GAIN (-) Adjustment Button
- 2 – GAIN (+) Adjustment Button
- 3 – Manual Brake Control Lever

The user interface consists of the following:

GAIN Adjustment Buttons (+/-)

Pushing these buttons will adjust the brake control power output to the trailer brakes in 0.5 increments. The GAIN setting can be increased to a maximum of 10 or decreased to a minimum of 0 (no trailer braking).

GAIN

The GAIN setting is used to set the trailer brake control for the specific towing condition and should be changed as towing conditions change. Changes to towing conditions include trailer load, vehicle load, road conditions and weather.

Manual Brake Control Lever

Slide the manual brake control lever to the left to activate power to the trailer's electric brakes independent of the tow vehicle's brakes. If the manual brake control lever is activated while the brake is also applied, the greater of the two inputs determines the power sent to the trailer brakes.

The trailer and the vehicle's stop lamps will come on when braking normally with the vehicle brake pedal. Only the trailer stop lamps will come on when the manual brake control lever is applied.

Trailer Brake Status Indicator Light

This light indicates the trailer electrical connection status.

If no electrical connection is detected after the ignition is turned on, pushing the GAIN adjustment button or sliding the manual brake control lever will display the GAIN setting for 10 seconds and the Trailer Brake Status Indicator Light will not be displayed.

If a fault is detected in the trailer wiring or the Integrated Trailer Brake Module (ITBM), the Trailer Brake Status Indicator Light will flash.

Adjusting GAIN

NOTE:

This should only be performed in a traffic free environment at speeds of approximately 20–25 mph (30–40 km/h).

1. Make sure the trailer brakes are in good working condition, functioning normally and properly adjusted. See your trailer dealer if necessary.

2. Hook up the trailer and make the electrical connections according to the trailer manufacturer's instructions.
 3. When a trailer is plugged in with electric or EOH brakes, the trailer connected message should appear in the instrument cluster display (if the connection is not recognized by the ITBM, braking functions will not be available), the GAIN setting will illuminate and the correct type of trailer must be selected from the instrument cluster display options.
 4. Push the UP or DOWN button on the steering wheel until "TRAILER TOW" appears on the screen.
 5. Push the RIGHT arrow on the steering wheel to enter "TRAILER TOW".
 6. Push the UP or DOWN buttons until the Trailer Brake Type appears on the screen.
 7. Push the RIGHT arrow and then push the UP or DOWN buttons until the proper Trailer Brake Type appears on the screen.
 8. In a traffic-free environment, tow the trailer on a dry, level surface at a speed of 20–25 mph (30–40 km/h) and squeeze the manual brake control lever completely.
 9. If the trailer wheels lockup (indicated by squealing tires), reduce the GAIN setting; if the trailer wheels turn freely, increase the GAIN setting.
- Repeat steps 8 and 9 until the GAIN setting is at a point just below trailer wheel lockup. If towing a heavier trailer, trailer wheel lockup may not be attainable even with the maximum GAIN setting of 10.

	Light Electric	Heavy Electric	Light EOH	Heavy EOH
Type of Trailer Brakes	Electric Trailer Brakes	Electric Trailer Brakes	Electric Over Hydraulic Trailer Brakes	Electric Over Hydraulic Trailer Brakes
Load	*Under 10,000 lb	*Above 10,000 lb	*Under 10,000 lb	*Above 10,000 lb

*The suggested selection may change depending on the customer preferences for braking performance. Condition of the trailer brakes, driving and road state may also affect the selection.

Display Messages

The trailer brake control interacts with the instrument cluster display. Display messages, along with a single chime, will be displayed when a malfunction is determined in the trailer connection, trailer brake control, or on the trailer → page 116.

WARNING!

Connecting a trailer that is not compatible with the ITBM system may result in reduced or complete loss of trailer braking. There may be an increase in stopping distance or trailer instability which could result in personal injury.

CAUTION!

Connecting a trailer that is not compatible with the ITBM system may result in reduced or complete loss of trailer braking. There may be an increase in stopping distance or trailer instability which could result in damage to your vehicle, trailer, or other property.

NOTE:

- An aftermarket controller may be available for use with trailers with air or EOH trailer brake systems.

To determine the type of brakes on your trailer and the availability of controllers, check with your trailer manufacturer or dealer.

- Removal of the ITBM will cause errors and it may cause damage to the electrical system and electronic modules of the vehicle. See an authorized dealer if an aftermarket module is to be installed.

Towing Requirements – Trailer Lights And Wiring

Whenever you pull a trailer, regardless of the trailer size, stop lights and turn signals on the trailer are required for motor safety.

The Trailer Tow Package may include a four- and seven-pin wiring harness. Use a factory approved trailer harness and connector.

NOTE:

Do not cut or splice wiring into the vehicle's wiring harness.

The electrical connections are all complete to the vehicle but you must connect the harness to a trailer connector. Refer to the following illustrations.

NOTE:

- Disconnect the trailer wiring connector from the vehicle (or any other device plugged into vehicle's electrical connectors) before launching a boat into water.
- Be sure to reconnect once clear from water area.

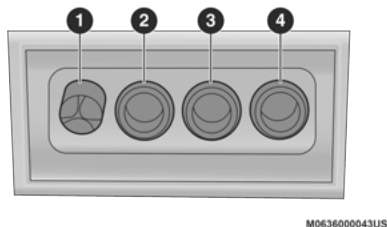

Four-Pin Connector

- 1 – Ground
- 2 – Park
- 3 – Left Stop/Turn
- 4 – Right Stop/Turn

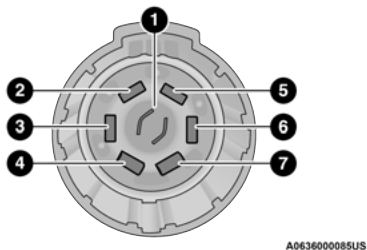

Seven-Pin Connector

- 1 – Backup Lamps
- 2 – Running Lamps
- 3 – Left Stop/Turn
- 4 – Ground
- 5 – Battery
- 6 – Right Stop/Turn
- 7 – Electric Brakes

Trailer Light Check

This feature will run the trailer lights through a sequence to check the trailer light function. It is available in the Instrument Cluster under the Trailer Tow menu → page 279.

When activated the feature will enable all of the exterior lights sequentially for up to five minutes for time to walk around and verify functionality. The following exterior lights will remain on for the entirety of the sequence:

- Park/Running Lamps
- Side Marker Lamps (if equipped)
- License Lamp
- Signature Lamp (if equipped)
- Low Beams
- Fog Lamps (if equipped)
- Daytime Running Lamps

During this time the following lights will sequence, each activating for three seconds:

1. Brake and CHMSL (third brake light)
2. Left turn signal
3. Right turn signal

4. Reverse Lamps
5. High Beam

This light check sequence will continue for a total of five minutes.

The sequence will only activate if the following conditions are met:

- Vehicle is equipped with the Trailer Tow Package
- Vehicle is in PARK
- Vehicle is not in motion
- Ignition is in ON/RUN
- Remote start is inactive
- Brakes are not applied
- Left turn signal is not applied
- Right turn signal is not applied
- Hazard switch is not applied

The sequence will cancel if any of the following conditions occur:

- Brakes are applied
- Vehicle is shifted from PARK
- Vehicle is no longer stationary
- Left turn signal activated from stalk
- Right turn signal is activated from stalk
- Hazard switch is activated
- Any button on the key fob is pushed
- Ignition button is pushed

- High Beam stalk position is changed
- Sequence is canceled in the instrument cluster

TOWING TIPS

Before towing, practice turning, stopping, and backing up the trailer in an area located away from heavy traffic.

Automatic Transmission

The DRIVE range can be selected when towing. The transmission controls include a drive strategy to avoid frequent shifting when towing. However, if frequent shifting does occur while in DRIVE, select TOW/HAUL mode or select a lower gear range (using the Electronic Range Select (ERS) shift control).

NOTE:

Using TOW/HAUL mode or selecting a lower gear range (using the ERS shift control) while operating the vehicle under heavy loading conditions will improve performance and extend transmission life by reducing excessive shifting and heat buildup. This action will also provide better engine braking.

If you REGULARLY tow a trailer for more than 45 minutes of continuous operation, then change the transmission fluid and filter as specified for “police, taxi, fleet, or frequent trailer towing”. Refer to the “Maintenance Plan” for the proper maintenance intervals.

Electronic Range Select (ERS)

- When using the ERS shift control, select the highest gear that allows for adequate performance and avoids frequent downshifts. For example, choose “4”

if the desired speed can be maintained. Choose “3” or “2” if needed to maintain the desired speed.

- To prevent excess heat generation, avoid continuous driving at high RPM. Reduce vehicle speed as necessary to avoid extended driving at high RPM. Return to a higher gear range or vehicle speed when grade and road conditions allow.

Tow/Haul Mode

To reduce potential for automatic transmission overheating, activate TOW/HAUL mode when driving in hilly areas, or select a lower gear range (using the (ERS) shift control) on more severe grades.

Cruise Control — If Equipped

- Do not use on hilly terrain or with heavy loads.
- When using the Cruise Control, if you experience speed drops greater than 10 mph (16 km/h), disengage until you can get back to cruising speed.
- Use Cruise Control in flat terrain and with light loads to maximize fuel efficiency.

Air Suspension System

To aid in attaching/detaching the trailer from the vehicle, the air suspension system can be used  page 157. Selecting Tow/Haul or connecting a trailer with an Integrated Trailer Brake Module (ITBM) will disable Automatic Aero mode to avoid height changes while towing and shifting loads or tongue weights.

NOTE:

The vehicle must remain in the engine running position while attaching a trailer for proper leveling of the air suspension system.

RECREATIONAL TOWING (BEHIND MOTORHOME)

TOWING THIS VEHICLE BEHIND ANOTHER VEHICLE

Towing Condition	Wheels OFF The Ground	Two-Wheel Drive Models	Four-Wheel Drive Models
Flat Tow	NONE	NOT ALLOWED	See Instructions <ul style="list-style-type: none"> ● Transfer case in N (Neutral) ● Transmission in PARK ● Tow in forward direction
Dolly Tow	Front	NOT ALLOWED	NOT ALLOWED
	Rear	OK	NOT ALLOWED
On Trailer	ALL	OK	OK

NOTE:

- When towing your vehicle, always follow applicable state and provincial laws. Contact state and provincial Highway Safety offices for additional details.
- Vehicles equipped with Active-Level Four Corner Air Suspension must be placed in Transport mode before tying them down (from the body) on a trailer or flatbed truck ➞ page 157. If the vehicle cannot be placed in Transport mode (for example, engine will not run), tie-downs must be fastened to the axles (not to the body). Failure to follow these instructions may cause fault codes to be set and/or cause loss of proper tie-down tension.

RECREATIONAL TOWING — TWO-WHEEL DRIVE MODELS

DO NOT flat tow this vehicle. Damage to the drivetrain will result.

Recreational towing (for two-wheel drive models) is allowed **ONLY** if the rear wheels are **OFF** the ground.

This may be accomplished using a tow dolly or vehicle trailer. If using a tow dolly, follow this procedure:

NOTE:

If vehicle is equipped with air suspension, ensure the vehicle is set to Normal Ride Height.

1. Properly secure the dolly to the tow vehicle, following the dolly manufacturer's instructions.
2. Drive the rear wheels onto the tow dolly.
3. Apply the parking brake. Place the transmission in PARK.

4. Properly secure the rear wheels to the dolly, following the dolly manufacturer's instructions.
5. Turn the ignition OFF.
6. Install a suitable clamping device, designed for towing, to secure the front wheels in the straight position.

CAUTION!

Towing with the rear wheels on the ground will cause severe transmission damage. Damage from improper towing is not covered under the New Vehicle Limited Warranty.

RECREATIONAL TOWING — FOUR-WHEEL DRIVE MODELS

NOTE:

The transfer case must be shifted into N (Neutral) for recreational towing. The transmission must be shifted into PARK for recreational towing. Refer to the following for the proper transfer case N (Neutral) shifting procedure for your vehicle.

CAUTION!

- DO NOT dolly tow any 4WD vehicle. Towing with only one set of wheels on the ground (front or rear) will cause severe transmission and/or transfer case damage. Tow with all four wheels either ON the ground, or OFF the ground (using a vehicle trailer).

(Continued)

CAUTION!

- Tow only in the forward direction. Towing this vehicle backwards can cause severe damage to the transfer case.
- Before recreational towing, the transfer case must be in N (Neutral). To be certain the transfer case is fully in N (Neutral), perform the procedure outlined under "Shifting Into N (Neutral)". Internal transmission damage will result, if the transfer case is not in N (Neutral) during towing.
- The transmission must be in PARK for recreational towing.
- Ensure that the Electric Park Brake is released, and remains released, while being towed.
- Towing this vehicle in violation of these listed requirements can cause severe transmission and/or transfer case damage. Damage from improper towing is not covered under the New Vehicle Limited Warranty.
- Do not disconnect the rear driveshaft because fluid will leak from the transfer case, causing damage to internal parts.
- Do not use a fascia/bumper-mounted clamp-on tow bar on your vehicle. The fascia/bumper face bar will be damaged.

Shifting Into N (Neutral)

Use the following procedure to prepare your vehicle for recreational towing.

WARNING!

You or others could be injured or killed if you leave the vehicle unattended with the transfer case in the N (Neutral) position without first fully engaging the parking brake. The transfer case N (Neutral) position disengages both the front and rear driveshafts from the powertrain and will allow the vehicle to roll, even if the transmission is in PARK. The parking brake should always be applied when the driver is not in the vehicle.

CAUTION!

It is necessary to follow these steps to be certain that the transfer case is fully in N (Neutral) before recreational towing to prevent damage to internal parts.

1. Bring the vehicle to a complete stop on level ground, with the engine running. Apply the parking brake.
2. Press and hold the brake pedal.
3. Shift the transmission to NEUTRAL. The driver's door must be closed (or the driver's seat belt buckled) so that the transmission will remain in NEUTRAL when the brake pedal is released.

NOTE:

If vehicle is equipped with air suspension, ensure the vehicle is set to Normal Ride Height.

4. Using a ballpoint pen or similar object, push and hold the recessed transfer case N (Neutral) button (at the center of the transfer case switches). The N (Neutral) indicator light will illuminate, and remain

lit, when the shift to N (Neutral) is complete. After the shift is completed and the N (Neutral) light stays on, release the N (Neutral) button.

5. Release the parking brake.
6. Shift the transmission into REVERSE.
7. Release the brake pedal for five seconds and ensure that there is no vehicle movement.
8. Repeat steps 6 and 7 with the transmission in DRIVE.
9. Shift the transmission to NEUTRAL. Apply the parking brake. Turn off the engine. For vehicles with Keyless Enter 'n Go™, push and hold the ENGINE START/STOP button until the engine shuts off. The transmission will automatically select PARK when the engine is turned off.
10. Turn the ignition off.
11. Attach the vehicle to the tow vehicle using a suitable tow bar.
12. Turn the ignition to the ON/RUN mode, but do not start the engine.
13. Release the parking brake.
14. Turn the ignition OFF.

NOTE:

- Steps 2 and 3 are requirements that must be met before pushing the N (Neutral) button, and must continue to be met until the shift has been completed. If any of these requirements are not met before pushing the N (Neutral) button or are no longer met during the shift, the N (Neutral) indicator light will flash continuously until all requirements are met or until the N (Neutral) button is released.

- The ignition must be in the ON/RUN mode for a shift to take place and for the position indicator lights to be operable. If the ignition is not in the ON/RUN mode, the shift will not take place and no position indicator lights will be on or flashing.
- A flashing N (Neutral) position indicator light indicates that shift requirements have not been met.
- If the vehicle is equipped with air suspension, the engine should be started and left running for a minimum of 60 seconds (with all the doors closed) at least once every 24 hours. This process allows the air suspension to adjust the vehicle's ride height to compensate for temperature effects.

Shifting Out Of N (Neutral)

Use the following procedure to prepare your vehicle for normal usage:

1. Bring the vehicle to a complete stop, leaving it connected to the tow vehicle.
2. Press and hold the brake pedal.
3. Start the engine. Apply the parking brake. Shift the transmission into NEUTRAL.
4. Using a ballpoint pen or similar object, push and hold the recessed transfer case N (Neutral) button (at the center of the transfer case switches).
5. When the N (Neutral) indicator light turns off, release the N (Neutral) button.
6. Turn the engine off. The transmission will automatically select PARK when the engine is turned off.
7. Release the brake pedal.

8. Disconnect vehicle from the tow vehicle.
9. Press and hold the brake pedal.
10. Start the engine.
11. Release the parking brake.
12. Shift the transmission into DRIVE, release the brake pedal, and check that the vehicle operates normally.

NOTE:

- Steps 3 and 4 are requirements that must be met before pushing the button to shift out of N (Neutral), and must continue to be met until the shift has been completed. If any of these requirements are not met before pushing the button or are no longer met during the shift, the N (Neutral) indicator light will flash continuously until all requirements are met or until the button is released.
- The ignition must be in the ON/RUN mode for a shift to take place and for the position indicator lights to be operable. If the ignition is not in the ON/RUN mode, the shift will not take place and no position indicator lights will be on or flashing.
- A flashing N (Neutral) position indicator light indicates that shift requirements have not been met.

DRIVING TIPS

DRIVING ON SLIPPERY SURFACES

Acceleration

Rapid acceleration on snow covered, wet, or other slippery surfaces may cause the driving wheels to pull

erratically to the right or left. This phenomenon occurs when there is a difference in the surface traction under the rear (driving) wheels.

WARNING!

Rapid acceleration on slippery surfaces is dangerous. Unequal traction can cause sudden pulling of the rear wheels. You could lose control of the vehicle and possibly have a collision. Accelerate slowly and carefully whenever there is likely to be poor traction (ice, snow, wet, mud, loose sand, etc.).

DRIVING THROUGH WATER

Driving through water more than a few inches/centimeters deep will require extra caution to ensure safety and prevent damage to your vehicle.

Flowing/Rising Water

WARNING!

Do not drive on or across a road or path where water is flowing and/or rising (as in storm run-off). Flowing water can wear away the road or path's surface and cause your vehicle to sink into deeper water. Furthermore, flowing and/or rising water can carry your vehicle away swiftly. Failure to follow this warning may result in injuries that are serious or fatal to you, your passengers, and others around you.

Shallow Standing Water

Although your vehicle is capable of driving through shallow standing water, consider the following Cautions and Warnings before doing so.

WARNING!

- Driving through standing water limits your vehicle's traction capabilities. Do not exceed 5 mph (8 km/h) when driving through standing water.
- Driving through standing water limits your vehicle's braking capabilities, which increases stopping distances. Therefore, after driving through standing water, drive slowly and lightly press on the brake pedal several times to dry the brakes.
- Failure to follow these warnings may result in injuries that are serious or fatal to you, your passengers, and others around you.

CAUTION!

- Always check the depth of the standing water before driving through it. Never drive through standing water that is deeper than the bottom of the tire rims mounted on the vehicle.
- Determine the condition of the road or the path that is under water and if there are any obstacles in the way before driving through the standing water.
- Do not exceed 5 mph (8 km/h) when driving through standing water. This will minimize wave effects.
- Driving through standing water may cause damage to your vehicle's drivetrain components. Always inspect your vehicle's fluids (i.e., engine oil, transmission, axle, etc.) for signs of contamination (i.e., fluid that is milky or foamy in appearance)

(Continued)

CAUTION!

- after driving through standing water. Do not continue to operate the vehicle if any fluid appears contaminated, as this may result in further damage. Such damage is not covered by the New Vehicle Limited Warranty.
- Getting water inside your vehicle's engine can cause it to lock up and stall out, and cause serious internal damage to the engine. Such damage is not covered by the New Vehicle Limited Warranty.

OFF-ROAD DRIVING TIPS

Care should be taken when attempting to climb steep hills or driving diagonally across a hill or slope. If natural obstacles force you to travel diagonally up or down a hill, choose a mild angle and keep as little side tilt as possible. Keep the vehicle moving and make turns slowly and cautiously.

If you must back down a hill, back straight down using REVERSE gear. Never back down in NEUTRAL or diagonally across the hill.

When driving over sand, mud, and other soft terrain, shift to low gear and drive steadily. Apply the accelerator slowly to avoid spinning the wheels.

Do not reduce the tire pressures for this type of driving.

After Driving Off-Road

Off-road operation puts more stress on your vehicle than does most on-road driving. After going off-road, it is always a good idea to check for damage. That way you can get any problems taken care of right away and have your vehicle ready when you need it.

- Completely inspect the underbody of your vehicle. Check tires, body structure, steering, suspension, and exhaust system for damage.
- Inspect the radiator for mud and debris and clean as required.
- Check threaded fasteners for looseness, particularly on the chassis, drivetrain components, steering, and suspension. Retighten them, if required, and torque to the values specified in the Service Manual.
- Check for accumulations of plants or brush. These things could be a fire hazard. They might hide damage to fuel lines, brake hoses, axle pinion seals, and propeller shafts.
- After extended operation in mud, sand, water, or similar dirty conditions, have the radiator, fan, brake rotors, wheels, brake linings, and axle yokes inspected and cleaned as soon as possible.

WARNING!

Abrasive material in any part of the brakes may cause excessive wear or unpredictable braking. You might not have full braking power when you need it to prevent a collision. If you have been operating your vehicle in dirty conditions, get your brakes checked and cleaned as necessary.

- If you experience unusual vibration after driving in mud, slush or similar conditions, check the wheels for impacted material. Impacted material can cause a wheel imbalance and freeing the wheels of it will correct the situation.

DRIVING TIPS — RHO

ON-ROAD DRIVING TIPS

Off-road trucks have higher ground clearance and increased suspension travel to make them capable of performing in a wide variety of off-road applications. Specific design characteristics give them a higher center of gravity than conventional passenger cars.

An advantage of the higher ground clearance is a better view of the road, allowing you to anticipate problems. They are not designed for cornering at the same speeds as conventional passenger cars any more than low-slung sports cars are designed to perform satisfactorily in off-road conditions. Avoid sharp turns or abrupt maneuvers. As with other vehicles of this type, failure to operate this vehicle correctly may result in loss of control or vehicle rollover.

OFF-ROAD DRIVING TIPS

The Basics Of Off-Road Driving

You will encounter many types of terrain driving off-road. You should be familiar with the terrain and area before proceeding. There are many types of surface conditions: hard-packed dirt, gravel, rocks, grass, sand, mud, snow and ice. Every surface has a different affect on your vehicle's steering, handling and traction. Controlling your vehicle is one of the keys to successful off-road driving, so always keep a firm grip on the steering wheel and maintain a good driving posture. Avoid sudden accelerations, turns or braking. In most cases, there are no road signs, posted speed limits or signal lights. Therefore, you will need to use your

own good judgment on what is safe and what is not. When on a trail, you should always be looking ahead for surface obstacles and changes in terrain. The key is to plan your future driving route while remembering what you are currently driving over.

WARNING!

Always wear your seat belt and firmly tie down cargo. Unsecured cargo can become projectiles in an off-road situation.

CAUTION!

Never park your vehicle over dry grass or other combustible materials. The heat from your vehicle exhaust system could cause a fire.

When To Use 4WD LOW

When off-road driving, shift into 4WD LOW for additional traction and control on slippery or difficult terrain, ascending or descending steep hills, and to increase low speed pulling power. This range should be limited to extreme situations such as deep snow, mud, steep inclines, or sand where additional low speed pulling power is needed. Vehicle speeds in excess of 55 mph (88 km/h) should be avoided when in 4WD LOW.

CAUTION!

Do not use 4WD LOW when operating the vehicle on dry pavement. Driveline hardware damage can result.

Simultaneous Brake And Throttle Operation

Many off-road driving conditions require the simultaneous use of the brake and throttle (two-footed driving). When climbing rocks, logs, or other stepped objects, using light brake pressure with light throttle will keep the vehicle from jerking or lurching. This technique is also used when you need to stop and restart a vehicle on a steep incline.

Driving In Snow, Mud And Sand

SNOW

In heavy snow or for additional control and traction at slower speeds, select SNOW mode from the RHO modes. This will optimize traction and stability in these conditions. Do not shift to a lower gear than necessary to maintain headway. Over-revving the engine can spin the wheels and traction will be lost. If you start to slow to a stop, try turning your steering wheel no more than a quarter turn quickly back and forth, while still applying throttle. This will allow the tires to get fresh traction and help maintain your momentum.

CAUTION!

On icy or slippery roads, do not downshift at high engine RPM or vehicle speeds, because engine braking may cause skidding and loss of control.

MUD

Deep mud creates a great deal of suction around the tires and is very difficult to get through. Select SAND/MUD mode from the RHO modes for optimum

traction and maneuverability in these conditions. If you start to slow to a stop, try turning your steering wheel no more than a quarter turn quickly back and forth for additional traction. Mud holes pose an increased threat of vehicle damage and getting stuck. They are normally full of debris from previous vehicles getting stuck. As a good practice before entering any mud hole, get out and determine how deep it is, if there are any hidden obstacles and if the vehicle can be safely recovered if stuck.

SAND

Select MUD/SAND from the RHO modes. Soft sand is very difficult to travel through with full tire pressure. When crossing soft, sandy spots in a trail, maintain your vehicle's momentum and do not stop. The key to driving in soft sand is using the appropriate tire pressure, accelerating slowly, avoiding abrupt maneuvers and maintaining the vehicle's momentum. If you are going to be driving on large soft sandy areas or dunes, reduce your tire pressure to a minimum of 15 psi (103 kPa) to allow for a greater tire surface area. Reduced tire pressure will drastically improve your traction and handling while driving on the soft sand, but you must return the tires to normal air pressure before driving on pavement or other hard surfaces. Be sure you have a way to reinflate the tires prior to reducing the pressure.

CAUTION!

Reduced tire pressures may cause tire unseating and total loss of air pressure. To reduce the risk of tire unseating, while at a reduced tire pressure, reduce your speed and avoid sharp turns or abrupt maneuvers.

Crossing Obstacles (Rocks And Other High Points)

While driving off-road, you will encounter many types of terrain. These varying types of terrain bring different types of obstacles. Before proceeding, review the path ahead to determine the correct approach and your ability to safely recover the vehicle if something goes wrong. Keeping a firm grip on the steering wheel, bring the vehicle to a complete stop and then inch the vehicle forward until it makes contact with the object. Apply the throttle lightly while holding a light brake pressure and ease the vehicle up and over the object.

WARNING!

Crossing obstacles can cause abrupt steering system loading which could cause you to lose control of your vehicle.

USING A SPOTTER

There are many times where it is hard to see the obstacle or determine the correct path. Determining the correct path can be extremely difficult when you are confronting many obstacles. In these cases have someone guide you over, through, or around the obstacle. Have the person stand a safe distance in front of you where they can see the obstacle, watch your tires and undercarriage, and guide you through.

CROSSING LARGE ROCKS

When approaching large rocks, choose a path which ensures you drive over the largest of them with your tires. This will lift your undercarriage over the obstacle. The tread of the tire is tougher and thicker than the

side wall and is designed to take the abuse. Always look ahead and make every effort to cross the large rocks with your tires.

CAUTION!

- Never attempt to straddle a rock that is large enough to strike your axles or undercarriage.
- Never attempt to drive over a rock which is large enough to contact the door sills.

CROSSING A RAVINE, GULLY, DITCH, WASHOUT OR RUT

When crossing a ravine, gully, ditch, washout or a large rut, the angled approach is the key to maintaining your vehicle's mobility. Approach these obstacles at a 45-degree angle and let each tire go through the obstacle independently. You need to use caution when crossing large obstacles with steep sides. Do not attempt to cross any large obstacle with steep sides at an angle great enough to put the vehicle at risk of a rollover. If you get caught in a rut, dig a small trench to the right or left at a 45-degree angle ahead of the front tires. Use the removed dirt to fill the rut ahead of the turnout you just created. You should now be able to drive out following the trench you just created at a 45-degree angle.

WARNING!

There is an increased risk of rollover when crossing an obstacle, at any angle, with steep sides.

CROSSING LOGS

To cross a log, approach it at a slight angle (approximately 10 to 15 degrees). This allows one front tire to be on top of the log while the other just starts to climb the log. While climbing the log, modulate your brake and accelerator to avoid spinning the log out from under your tires. Then ease the vehicle off the log using your brakes.

CAUTION!

Do not attempt to cross a log with a greater diameter than the running ground clearance or the vehicle will become high-centered.

GETTING HIGH-CENTERED

If you get hung up or high-centered on an object, get out of the vehicle and try to determine what the vehicle is hung up on, where it is contacting the underbody and what is the best direction to recover the vehicle. Depending on what you are in contact with, jack the vehicle up and place a few rocks under the tires so the weight is off of the high point when you let the vehicle down. You can also try rocking the vehicle or winching the vehicle off the object.

CAUTION!

Winching or rocking the vehicle off hard objects increases the risk of underbody damage.

Hill Climbing

Hill climbing requires good judgment and a good understanding of your abilities and your vehicle's

limitations. Hills can cause serious problems. Some are just too steep to climb and should not be attempted. You should always feel confident with the vehicle and your abilities. You should always climb hills straight up and down. Never attempt to climb a hill on an angle.

BEFORE CLIMBING A STEEP HILL

As you approach a hill, consider its grade or steepness. Determine if it is too steep. Look to see what the traction is on the hill side trail. Is the trail straight up and down? What is on top and the other side? Are there ruts, rocks, branches or other obstacles on the path? Can you safely recover the vehicle if something goes wrong? If everything looks good and you feel confident, shift the transmission into a lower gear with 4WD LOW engaged, and proceed with caution, maintaining your momentum as you climb the hill.

DRIVING UPHILL

Once you have determined your ability to proceed and have shifted into the appropriate gear, line your vehicle up for the straightest possible run. Accelerate with an easy constant throttle and apply more power as you start up the hill. Do not race forward into a steep grade; the abrupt change of grade could cause you to lose control. If the front end begins to bounce, ease off the throttle slightly to bring all four tires back on the ground. As you approach the crest of the hill, ease off the throttle and slowly proceed over the top. If the wheels start to slip as you approach the crest of a hill, ease off the accelerator and maintain headway by turning the steering wheel no more than a quarter turn quickly back and forth. This will provide fresh traction into the surface and will usually provide enough traction to complete the climb. If you do not

make it to the top, place the vehicle in REVERSE and back straight down the grade using engine resistance along with the vehicle brakes.

WARNING!

Never attempt to climb a hill at an angle or turn around on a steep grade. Driving across an incline increases the risk of a rollover, which may result in severe injury.

DRIVING DOWNHILL

Before driving down a steep hill, you need to determine if it is too steep for a safe descent. What is the surface traction? Is the grade too steep to maintain a slow, controlled descent? Are there obstacles? Is it a straight descent? Is there plenty of distance at the base of the hill to regain control if the vehicle descends too fast? If you feel confident in your ability to proceed, then make sure you are in 4WD LOW and proceed with caution. Allow engine braking to control the descent and apply your brakes, if necessary, but do not allow the tires to lock.

WARNING!

Do not descend a steep grade in NEUTRAL. Use vehicle brakes in conjunction with engine braking. Descending a grade too fast could cause you to lose control and be seriously injured or killed.

DRIVING ACROSS AN INCLINE

If at all possible, avoid driving across an incline. If it is necessary, know your vehicle's abilities. Driving across an incline places more weight on the downhill wheels,

which increases the possibility of a downhill slide or rollover. Make sure the surface has good traction with firm and stable soils. If possible, transverse the incline at an angle heading slightly up or down.

WARNING!

Driving across an incline increases the risk of a rollover, which may result in severe injury.

IF YOU STALL OR BEGIN TO LOSE HEADWAY

If you stall or begin to lose headway while climbing a steep hill, allow your vehicle to come to a stop and immediately apply the brake. Restart the engine and shift into REVERSE. Back slowly down the hill allowing engine braking to control the descent and apply your brakes, if necessary, but do not allow the tires to lock.

WARNING!

If the engine stalls or you lose headway or cannot make it to the top of a steep hill or grade, never attempt to turn around. To do so may result in tipping and rolling the vehicle, which may result in severe injury. Always back carefully straight down a hill in REVERSE. Never back down a hill in NEUTRAL using only the vehicle brakes. Never drive diagonally across a hill, always drive straight up or down.

Driving Through Water

Extreme care should be taken crossing any type of water. Water crossings should be avoided, if possible, and only be attempted when necessary in a safe, responsible manner. Only drive through areas which are designated and approved. Tread lightly and avoid

damage to the environment. Know your vehicle's abilities and be able to recover it if something goes wrong. Never stop or shut a vehicle off when crossing deep water unless you ingested water into the engine air intake. If the engine stalls, do not attempt to restart it. Determine if it has ingested water first. The key to any crossing is low and slow. Shift into DRIVE, with the transfer case in the 4WD LOW position and proceed very slowly with a constant slow speed of (3 to 5 mph [5 to 8 km/h] maximum) and light throttle. Keep the vehicle moving; do not try to accelerate through the crossing. After crossing any water higher than the bottom of the axle differentials, inspect all of the vehicle fluids for signs of water ingestion.

CAUTION!

- Water ingestion into the axles, transmission, transfer case, engine or vehicle interior can occur if you drive too fast or through too deep of water. Water can cause permanent damage to engine, driveline or other vehicle components, and your brakes will be less effective once wet and/or muddy.
- When driving through water, do not exceed 5 mph (8 km/h). Always check water depth before entering as a precaution, and check all fluids afterward. Driving through water may cause damage that may not be covered by the New Vehicle Limited Warranty.

BEFORE YOU CROSS ANY TYPE OF WATER

As you approach any type of water, you need to determine if you can cross it safely and responsibly. If necessary, get out and walk through the water or

probe it with a stick. You need to be sure of its depth, approach angle, current and bottom condition. Be careful of murky or muddy waters; check for hidden obstacles. Make sure you will not be intruding on any wildlife, and you can recover the vehicle if necessary. The key to a safe crossing is the water depth, current and bottom conditions. On soft bottoms, the vehicle will sink in, effectively increasing the water level on the vehicle. Be sure to consider this when determining the depth and the ability to safely cross.

CROSSING PUDDLES, POOLS, FLOODED AREAS OR OTHER STANDING WATER

Puddles, pools, flooded or other standing water areas normally contain murky or muddy waters. These water types normally contain hidden obstacles and make it difficult to determine an accurate water depth, approach angle, and bottom condition. Murky or muddy water holes are where you want to hook up tow straps prior to entering. This makes for a faster, cleaner and easier vehicle recovery. If you are able to determine you can safely cross, then proceed using the low and slow method.

CAUTION!

Muddy waters can reduce the cooling system effectiveness by depositing debris onto the radiator.

CROSSING DITCHES, STREAMS, SHALLOW RIVERS OR OTHER FLOWING WATER

Flowing water can be extremely dangerous. Never attempt to cross a fast running stream or river even in shallow water. Fast moving water can easily push your vehicle downstream, sweeping it out of control. Even

in very shallow water, a high current can still wash the dirt out from around your tires putting you and your vehicle in jeopardy. There is still a high risk of personal injury and vehicle damage with slower water currents in depths greater than the vehicle's running ground clearance. You should never attempt to cross flowing water which is deeper than the vehicle's running ground clearance. Even the slowest current can push the heaviest vehicle downstream and out of control if the water is deep enough to push on the large surface area of the vehicle's body. Before you proceed, determine the speed of the current, the water's depth, approach angle, bottom condition and if there are any obstacles. Then cross at an angle heading slightly upstream using the low and slow technique.

WARNING!

Never drive through fast moving deep water. It can push your vehicle downstream, sweeping it out of control. This could put you and your passengers at risk of injury or drowning.

After Driving Off-Road

Off-road operation puts more stress on your vehicle than does most on-road driving. After going off-road, it is always a good idea to check for damage. That way you can get any problems taken care of right away and have your vehicle ready when you need it.

- Vehicles equipped with beadlock wheels may not be able to be operated legally on public roadways with the tire mounted in the locked position, please check regional and local laws.

- Completely inspect the underbody of your vehicle. Check tires, body structure, steering, suspension, and exhaust system for damage.
- Inspect the radiator for mud and debris and clean as required.
- Check threaded fasteners for looseness, particularly on the chassis, drivetrain components, steering, and suspension. Retighten them, if required, and torque to the values specified in the Service Manual.
- Check for accumulations of plants or brush. These things could be a fire hazard. They might hide damage to fuel lines, brake hoses, axle pinion seals, and propeller shafts.
- After extended operation in mud, sand, water, or similar dirty conditions, have the radiator, fan, brake rotors, wheels, brake linings, and axle yokes inspected and cleaned as soon as possible.

WARNING!

Abrasive material in any part of the brakes may cause excessive wear or unpredictable braking. You might not have full braking power when you need it to prevent a collision. If you have been operating your vehicle in dirty conditions, get your brakes checked and cleaned as necessary.

- If you experience unusual vibration after driving in mud, slush or similar conditions, check the wheels for impacted material. Impacted material can cause a wheel imbalance and freeing the wheels of it will correct the situation.

MULTIMEDIA

UCONNECT SYSTEMS

For detailed information about your Uconnect 5 With 8.4-inch Display system, your Uconnect 5 NAV With 12-inch Display system, or your Uconnect 5 NAV With 14.5-inch Display, refer to your Uconnect Radio Instruction Manual.

NOTE:

Uconnect screen images are for illustration purposes only and may not reflect exact software for your vehicle.

CYBERSECURITY

Depending on applicability, your vehicle may be able to send or receive information from a wired or wireless network. This information allows systems and features in your vehicle to function properly.

Your vehicle may be equipped with certain security features to reduce the risk of unauthorized and unlawful access to vehicle systems and wireless communications. Vehicle software technology continues to evolve over time and FCA US LLC, working with its suppliers, evaluates and takes appropriate steps as needed. As always, if you experience unusual behavior, contact an authorized dealer immediately, ➞ page 418, or refer to your Uconnect Radio Instruction Manual for additional contact information.

The risk of unauthorized and unlawful access to your vehicle systems may still exist, even if the most recent

version of vehicle software (such as Uconnect software) is installed.

WARNING!

- ONLY insert trusted devices/components into your vehicle. Media of unknown origin could possibly contain malicious software, and if installed in your vehicle, it may increase the possibility for vehicle systems to be breached.
- As always, if you experience unusual vehicle behavior, take your vehicle to an authorized dealer immediately.

NOTE:

To help further improve user experience, features, stability, etc., and minimize the potential risk of a security breach, vehicle owners should routinely check www.driveuconnect.com (US Residents) or www.driveuconnect.ca (Canadian Residents) to learn about available Uconnect software updates.

UCONNECT SETTINGS

The Uconnect system uses a combination of buttons on the touchscreen and buttons on the faceplate located on the center of the instrument panel. These buttons allow you to access and change the Customer Programmable Features. Many features can vary by vehicle.

Buttons on the faceplate are located below and/or beside the Uconnect system in the center of the instrument panel. In addition, there is a SCROLL/ENTER control knob located on the right side. Turn the control knob to scroll through menus and change settings. Push the center of the control knob one or more times to select or change a setting.

Your Uconnect system may also have SCREEN OFF and MUTE buttons on the faceplate.

Push the SCREEN OFF button on the faceplate to turn off the Uconnect screen. Push the button again or tap the screen to turn the screen on.

Press the Back Arrow button to exit out of a Menu or certain option on the Uconnect system.

Push and hold the Power button on the radio's faceplate for a minimum of 15 seconds to reset the radio.

CUSTOMER PROGRAMMABLE FEATURES

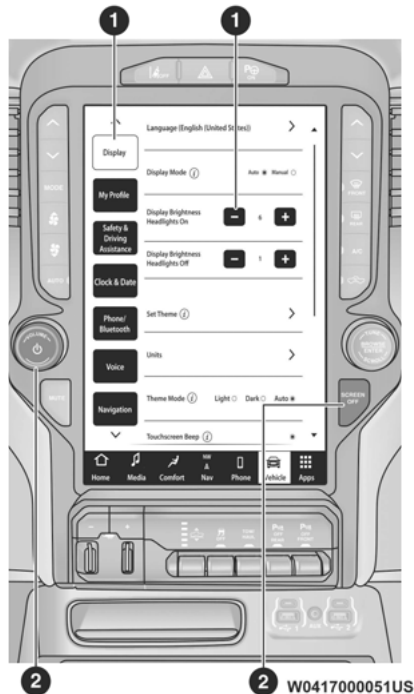

Uconnect 5 NAV With 12-inch
Display Touchscreen And Faceplate Buttons

1 – Uconnect Buttons On The Touchscreen

2 – Uconnect Buttons On The Faceplate

Press the Vehicle button, then press the Settings tab at the top of the touchscreen. In this menu, the Uconnect system allows you to access all of the available programmable features.

NOTE:

- Only one touchscreen may be selected at a time.
- Depending on the vehicle's options, feature settings may vary.

When making a selection, only press one button at a time to enter the desired menu. Once in the desired menu, press and release the preferred setting option until a check mark appears next to the setting, showing that setting has been selected. Once the setting is complete, press the X button on the touchscreen to close out of the settings screen. Pressing the Up or Down Arrow button on the right side of the screen will allow you to toggle up or down through the available settings.

Display

When the Display button is pressed on the touchscreen, the system will display the options related to the theme (if equipped), brightness, and color of the touchscreen. The available settings are:

NOTE:

Depending on the vehicle's options, feature settings may vary.

Setting Name	Description
Language	This setting will change the language of the Uconnect system and Instrument Cluster Display. The available languages are English, Français, and Español.
Display Mode	This setting will allow you to set the brightness manually or have the system set it automatically. The "Auto" setting has the system automatically adjust the display brightness. The "Manual" setting will allow the user to adjust the brightness of the display.
Display Brightness With Headlights ON/Brightness	This setting will allow you to set the brightness when the headlights are on. To access this setting, Display Mode must be set to Manual. The "+" setting will increase the brightness; the "-" will decrease the brightness.
Display Brightness With Headlights OFF/Brightness	This setting will allow you to set the brightness when the headlights are off. To access this setting, Display Mode must be set to Manual. The "+" setting will increase the brightness; the "-" will decrease the brightness.

Setting Name	Description
Set Theme	This setting will allow you to change the display theme.
Units	This setting will allow you to change the units. The available options are “Speed” (MPH or km/h), “Distance” (mi or km), “Pressure” (psi, kPa, or bar), “Temperature” (°C or °F), “Power” (HP [US], Gal HP [UK], or kW), and “Torque” (lb-ft or Nm) units of measurement independently.
Touchscreen Beep	This setting will allow you to turn the touchscreen beep on or off.
Control Screen Timeout	This setting allows you to set the Control Screen to turn off automatically after five seconds or stay open until manually closed.
Navigation Next Turn Pop-ups Displayed in Cluster	This setting will display navigation prompts in the Instrument Cluster Display.
Phone Pop-ups Displayed In Cluster	This setting will display smartphone notifications and messages in the Instrument Cluster Display.

Entertainment Screens — If Equipped

When the Entertainment Screens button is pressed on the touchscreen, the system displays options related to the vehicle's Entertainment.

NOTE:

Depending on the vehicle's options, feature settings may vary.

Setting Name	Description
Passenger Screen Permissions	This setting will enable or disable Passenger Screen Permissions. Options within this setting are "Navigation" and "Device Manager", and each have "On" and "Off" options.
Device Manager	This setting will open the Device Manager main screen.
Navigation	This setting will open the built in Navigation system if equipped.

My Profile

When the My Profile button is pressed on the touchscreen, the system displays options related to the vehicle's profiles.

NOTE:

Depending on the vehicle's options, feature settings may vary.

Setting Name	Description
Language	This setting will change the language of the Uconnect system and Instrument Cluster Display. The available languages are English, Français, and Español.
Display Mode	This setting will adjust the display for the radio to "Auto" or "Manual". "Manual" allows for more customization with the radio display.

Setting Name	Description
Display Brightness Nighttime	This setting will allow you to set the brightness when it is nighttime. To access this setting, Display Mode must be set to "Manual". The "+" setting will increase the brightness; the "-" will decrease the brightness.
Display Brightness Daytime	This setting will allow you to set the brightness when it is daytime. To access this setting, Display Mode must be set to "Manual". The "+" setting will increase the brightness; the "-" will decrease the brightness.
Set Theme	This setting will allow you to change the display theme in the touchscreen display, instrument cluster, and passenger screen display if equipped.
Units	This setting will allow you to change the units to "US", "Metric", or "Custom". The available options within Custom are "Speed" (MPH or km/h), "Distance" (mi or km), "Fuel Consumption" (MPG [US], MPG [UK], L/100 km, or km/L), "Pressure" (psi, kPa, or bar), "Temperature" (°C or °F), "Power" (HP [US], Gal HP [UK], or kW), and "Torque" (lb-ft or Nm) units of measurement independently.
Touchscreen Beep	This setting will allow you to turn the touchscreen beep on or off.
Show Main Category Bar Labels	This setting will allow the main category bar labels to be shown on or off.
Navigation Next Turn Pop-ups Displayed in Cluster	This setting will display navigation prompts in the Instrument Cluster Display.
Phone Pop-ups Displayed In Cluster	This setting will display smartphone notifications and messages in the Instrument Cluster Display.
Message Pop-Up Displayed With Button Press	This setting will activate or deactivate the message feature pop-ups.
Time Format	This setting will allow you to set the time format (AM/PM). Sync Time With GPS must be "Off" for this setting to be available. The "12 hrs" setting will set the time to a 12-hour format. The "24 hrs" setting will set the time to a 24-hour format.

Setting Name	Description
Voice Options	This setting will allow you to change the voice options for the radio to “Male” or “Female”.
Wake Up Word	This setting will allow you to set the system “Wake Up” word. The available options are “Off”, “Hey, Uconnect”, and “Hey, Ram”.
Voice Barge-in	This setting will allow Voice Barge-in to be turned on or off.
Show Command List	This setting will allow the Command List to be shown. The options are “On” and “Off”.
Radio Off Delay	This setting will keep the radio on for the selected amount of time after vehicle shut off. The available options are “0 sec”, “45 sec”, “5 min”, and “10 min”.
Navigation Settings	This setting will redirect to the list of Navigation settings. Refer to your Uconnect Radio Instruction Manual for further information.
Auto-On Driver Heated/Ventilated Seat & Heated Steering Wheel	This setting will activate the vehicle’s comfort system and heated seats or heated steering wheel when the vehicle is remote started or ignition is started. The “Off” setting will not activate the comfort systems. The “Remote Start” setting will only activate the comfort systems when using Remote Start. The “All Start” setting will activate the comfort systems whenever the vehicle is started.
Radio Power Off	This setting will keep certain electrical features running after the engine is turned off. When any door is opened, the electronics will deactivate. The available settings are “0 sec”, “45 sec”, “5 min”, and “10 min”.
Radio Off With Door	This setting will allow you to determine if the radio shuts off when any of the doors are opened.
Audio Settings	This setting will open the submenu, containing the audio settings ⇨ page 250.

Setting Name	Description
New Text Message Pop-ups	This setting will allow you to have pop-up notifications for new text messages. Setting options are "On" and "Off".
Missed Calls Message	This setting will allow you to have pop-up notifications for missed calls. Setting options are "On" and "Off".
Navigation Pop-ups	This setting will allow you to have pop-up notifications for Navigation. Setting options are "On" and "Off".
Reset App Drawer to Default Order	This setting will reset the app drawer to its factory default layout.
Restore Settings to Default	This setting will return all the previously changed settings to their factory defaults.
Trip B	This setting will turn the Trip B feature in the cluster on or off.
Audio Info On Cluster	This setting will turn the audio info on the cluster on or off.
Digital Speed On All Cluster Screens	This setting will show the digital speedometer on all cluster screens.
Consumption Bar On Cluster Screen	This setting will show the digital fuel consumption bar on all cluster screens.
Custom Areas On Cluster	This setting will allow you to customize the information displayed on the cluster.
More Profile Options	This setting will give access to more profile options.

Safety/Driving Assistance

When the Safety/Driving Assistance button is selected on the touchscreen, the system displays the options related to the vehicle's safety settings. These options will differ depending on the features equipped on the vehicle. The settings may display in list form or within subfolders on the screen. To access a subfolder, select the desired folder; the available options related to that feature will then display on the screen.

NOTE:

Depending on the vehicle's options, feature settings may vary.

Setting Name	Description
Forward Collision Warning Sensitivity — Located in Automatic Emergency Braking Submenu	This setting will change the distance at which the Forward Collision Warning (FCW) alert sounds. The "Medium" setting will have the FCW system signal when an object is in view, and the possibility of a collision is detected. The "Near" setting will have the FCW system signal when the object is closer to the vehicle. The "Far" setting will have the FCW system signal when an object is at a far distance from the vehicle.
Forward Collision Warning — Located in Automatic Emergency Braking Submenu	This setting will turn the Forward Collision Warning system on or off. The "Off" setting will deactivate the FCW system. The "Warning Only" setting will provide only an audible chime when a collision is detected. The "Warning + Active Braking" setting will provide an audible chime and apply some brake pressure when a collision is detected.
Traffic Sign Assist	This setting will turn Traffic Sign Assist on or off. This setting could be in a separate submenu.
Traffic Sign Assist Warning	This setting will allow you to set the warning type related to the traffic sign. The available options are "Off", "Visual", and "Visual + Chime". This setting could be in a separate submenu.
Traffic Sign Assist Offset	This setting will change the Traffic Sign Assist Sensitivity. The available options are "+ 0", "+ 5", and "+ 10". This setting could be in a separate submenu.
Pedestrian Emergency Braking — Located in Automatic Emergency Braking Submenu	This setting will turn the Pedestrian Emergency Braking system on or off.

Setting Name	Description
Lane Management – Located in Active Lane Management Submenu	This setting will alert the driver by vibrating the steering wheel and moving the steering wheel when a lane departure is detected. The available options within Active Lane Management are Lane Management “Vibration Only”, “Steering Assist Only”, and “Vibration + Steering Assist”
Lane Warning – Located in Active Lane Management Submenu	This setting will change the distance at which the steering wheel will provide lane departure feedback. The available settings are “Early”, “Medium”, and “Late”.
Vibration Strength – Located in Active Lane Management Submenu	This setting will change the strength of the steering wheel feedback during a lane departure. The available settings are “Low”, “Medium”, and “High”.
Steering Assist Strength – Located in Active Lane Management Submenu	This setting will change the strength of the steering assists system during a lane departure. The available settings are “Low”, “Medium”, and “High”.
Rear Seat Alert	When this setting is turned on and the rear doors are opened while the engine is running, or if the engine is turned on within 10 minutes of the door opening, a message will appear to check the rear seat when the vehicle is powered OFF.
ParkSense Based Camera Activation	This setting will activate or deactivate if ParkSense is active while a camera is running.
ParkSense	This setting will change the type of ParkSense alert when a close object is detected and can provide both an audible chime and a visual display.
Front ParkSense Volume	This setting adjusts the volume of the Front ParkSense system. The available settings are “Low”, “Medium”, and “High”.
Rear ParkSense Volume	This setting adjusts the volume of the Rear ParkSense system. The available settings are “Low”, “Medium”, and “High”.
Rear ParkSense Braking Assist	This setting will turn the Rear ParkSense Braking Assist on or off.

Setting Name	Description
Blind Spot Alert	This setting will change the type of alert provided when an object is detected in a vehicle's blind spot. The "Off" setting will turn off Blind Spot Alert. The "Lights" setting will activate the Blind Spot Alert lights on the outside mirrors. The "Lights & Chime" setting will activate both the lights on the outside mirrors and an audible chime.
Trailer Length For Blind Spot Alert	This setting will auto detect the length of an attached trailer. The "Auto" setting will have the system automatically set the trailer length. The "Max" setting will always set the length to the maximum 39.5 ft (12 m).
Hill Start Assist	This setting will turn the Hill Start Assist system on or off.
ParkView Backup Camera Delay	This setting will add a timed delay to the ParkView Backup Camera when shifting out of REVERSE.
ParkView Backup Camera Active Guidelines	This setting will turn the ParkView Backup Camera Active Guidelines on or off.
ParkView Backup Camera Fixed Guidelines	This setting will turn the ParkView Backup Camera Fixed Guidelines on or off.
Active ParkSense Mode	This setting will adjust the level of vehicle control when the Active ParkSense Mode is active. The available settings are "Full Auto" and "Steering Only"
Tire Fill Assist	This setting will turn Tire Fill Assist on or off.
Power Side Steps	This setting will raise and lower or stow the power side steps. The available options are "Automatic" to raise and lower the power side steps and "Stow" to deactivate the power side steps.
Rear Seat Alert	When this setting is turned on and the rear doors are opened while the engine is running, or if the engine is turned on within 10 minutes of the door opening, a message will appear to check the rear seat when the vehicle is powered off.

Setting Name	Description
ParkSense Front Camera Activation	This setting will allow you to enable or disable the front camera when an obstacle is detected.

Clock

When the Clock button is pressed on the touchscreen, the system displays the different options related to the vehicle's internal clock.

NOTE:

Depending on the vehicle's options, feature settings may vary.

Setting Name	Description
Sync Time With GPS	This setting will sync the time to the GPS receiver in the system. The system will control the time via the GPS location.
Set Time	This setting will allow you to set the hours and minutes. Sync Time With GPS must be off for this setting to be available. The "+" setting will increase the hours and minutes. The "-" setting will decrease the hours and minutes.
Time Format	This setting will allow you to set the time format (AM/PM). Sync Time With GPS must be off for this setting to be available. The "12 hrs" setting will set the time to a 12-hour format. The "24 hrs" setting will set the time to a 24-hour format.
Set Date	This setting will allow you to set the day, month and year. Using "+" or "-", you can scroll through the available days, months, and years.
Set Time Hours	This setting will allow you to set the hours. Sync Time With GPS must be off for this setting to be available. The "+" setting will increase the hours. The "-" setting will decrease the hours.

Setting Name	Description
Set Time Minutes	This setting will allow you to set the minutes. Sync Time With GPS must be off for this setting to be available. The "+" setting will increase the minutes. The "-" setting will decrease the minutes.
Show Time in Status Bar	This setting will place the time in the radio's status bar.
Show Time and Date During Screen Off	This setting will allow you to show the time and date while the screen is off. Available options are "On" and "Off".

Phone/Bluetooth®

When the Phone/Bluetooth® button is pressed on the touchscreen, the system displays the options related to Bluetooth® connectivity from an external audio device or smartphone. The list of paired audio devices or smartphones can be accessed from this menu.

NOTE:

Depending on the vehicle's options, feature settings may vary.

Setting Name	Description
Device Manager	This setting will open the Device Manager main screen.
Do Not Disturb All	This setting will open the Do Not Disturb Settings menu. The available options are "On" and "Off".
Enable Two Active Phones	This setting will enable or disable two active phones within the vehicle. The setting options are "On" and "Off".
Phone Pop-Ups Displayed In Cluster	This setting will activate phone message pop-ups in the Instrument Cluster Display.

Voice

When the Voice button is pressed on the touchscreen, the system displays the options related to the vehicle's Voice Recognition feature.

NOTE:

Depending on the vehicle's options, feature settings may vary.

Setting Name	Description
Voice Options	This setting will allow you to change the system's voice to either "Male" or "Female".
Wake Up Word	This setting will allow you to set the system's "Wake Up" word. The available options are "Off", "Hey, Uconnect", and "Hey, Ram".
Voice Barge-In	This setting allows you to respond to a Voice Response before the statement is completed by the system. The available options are "On" and "Off".
Show Command List	This setting will allow you to turn the Command List on or off. The "Always" setting will always show the Command List. The "With Help" setting will show the Command List and provide a brief description of what the command does. The "Never" setting will turn the Command List off.

Navigation

When the Navigation button is pressed on the touchscreen, the system displays options related to the vehicle's built-in Navigation system. These settings can change which icons display on the map, how "time to arrival is calculated", and route types.

For more information on Navigation and settings, refer to your Uconnect Radio Instruction Manual.

NOTE:

Depending on the vehicle's options, feature settings may vary.

Trailer Brake/Trailer – If Equipped

When the Trailer Brake/Trailer button is pressed on the touchscreen, the system will display settings related to trailer towing.

NOTE:

Depending on the vehicle's options, feature settings may vary.

Setting Name	Description
Auto Trailer Light Check	This setting can be used to check the trailer lights when the trailer is electrically connected to the vehicle. The available options are "On" and "Off".
Trailer 1	Options for each Trailer are "Use This Trailer", "Braking" (Light Electric, Heavy Electric, Light Electric Over Hydraulic, and Heavy Electric Over Hydraulic), "Trailer Name", and "Tire Pressure" (Setup All Tires, Replace Single Tire, Set Target Tire Pressure, and Delete Tire Settings).
Trailer 2	Options for each Trailer are "Use This Trailer", "Braking" (Light Electric, Heavy Electric, Light Electric Over Hydraulic, and Heavy Electric Over Hydraulic), "Trailer Name", and "Tire Pressure" (Setup All Tires, Replace Single Tire, Set Target Tire Pressure, and Delete Tire Settings).
Trailer 3	Options for each Trailer are "Use This Trailer", "Braking" (Light Electric, Heavy Electric, Light Electric Over Hydraulic, and Heavy Electric Over Hydraulic), "Trailer Name", and "Tire Pressure" (Setup All Tires, Replace Single Tire, Set Target Tire Pressure, and Delete Tire Settings).
Trailer 4	Options for each Trailer are "Use This Trailer", "Braking" (Light Electric, Heavy Electric, Light Electric Over Hydraulic, and Heavy Electric Over Hydraulic), "Trailer Name", and "Tire Pressure" (Setup All Tires, Replace Single Tire, Set Target Tire Pressure, and Delete Tire Settings).
Trailer Surround Camera	This setting will let you access options related to the "Trailer Surround Camera".

Camera

When the Camera button is pressed on the touchscreen, the system displays the options related to the vehicle's camera features.

NOTE:

Depending on the vehicle's options, feature settings may vary.

Setting Name	Description
Aux Camera	These settings are located in a separate submenu. They will access setting related to the Aux camera.
Surround View Camera Delay	This setting will add a timed delay to the Surround View Camera when shifting out of REVERSE.
Surround View Camera Guidelines	This setting will turn the Surround View Camera Guidelines on or off.
ParkView Backup Camera Delay	This setting will add a timed delay to the ParkView Backup Camera when shifting out of REVERSE.
ParkView Backup Camera Active Guidelines	This setting will turn the ParkView Backup Camera Active Guidelines on or off.
ParkView Backup Camera Fixed Guidelines	This setting will turn the ParkView Backup Camera Fixed Guidelines on or off.
Turn Signal Activated Blind Spot View	For vehicles not equipped with towing, this setting will allow you to enable or disable the turn signal blind spot view. For vehicles equipped with towing, the selectable options are "Off", "On", and "Only with Trailer".

Mirrors & Wipers

When the Mirrors & Wipers button is pressed on the touchscreen, the system displays the options related to the vehicle's mirrors and wipers.

NOTE:

Depending on the vehicle's options, feature settings may vary.

Setting Name	Description
Tilt Side Mirrors In Reverse	This setting will tilt the outside side-view mirrors when the ignition is in the ON/RUN position and the transmission gear selector is in the REVERSE position. The mirrors will move back to their previous position when the transmission is shifted out of REVERSE. The available settings are "On" and "Off".
Auto Folding Side Mirrors	This setting will automatically fold and unfold the side-view mirrors when the vehicle is turned off, the doors are locked, or the keyfob button is pushed. The available options are "On" and "Off".
Rain Sensing Auto Wipers	This setting will turn the Rain Sensing Auto Wipers on or off.
Headlights With Wipers	This setting will turn the headlights on when the wipers are activated.

Lights

When the Lights button is pressed on the touchscreen, the system displays the options related to the vehicle's exterior and interior lights.

NOTE:

- When the "Daytime Running Lights" feature is selected, the daytime running lights can be turned on or off. This feature is only allowed by law in the country of the vehicle purchase.
- Depending on the vehicle's options, feature settings may vary.

Setting Name	Description
Interior Ambient Lighting	This setting will allow you to adjust the brightness of the interior ambient lights. The available options are "Level 1" through "Level 6".
Headlight Illumination On Approach	This setting will allow you to set the amount of time it takes for the headlights to shut off after the vehicle is unlocked. The available settings are "0 sec", "30 sec", "60 sec", and "90 sec".
Proximity Wake-Up	Proximity detection is a system which activates specific interior and exterior lights as the vehicle is approached with a valid key fob. This feature provides an increased sense of welcome and security as the user enters the vehicle in the dark. This setting will turn the Proximity Wake-Up on or off. NOTE: For the exterior lighting to be activated, Headlight Illumination On Approach must be set to a value other than zero.
Greeting Lights	When the "Greeting Lights" feature is selected, it enables "Headlight Illumination On Approach". When "Headlight Illumination On Approach" is selected, it allows the adjustment of the amount of time the headlights remain on after the doors are unlocked with the key fob. "Greeting Lights" must be selected and "Headlight Illumination On Approach" must be selected above zero seconds for the feature to be enabled. The available settings are "On" and "Off".
Headlight Off Delay	This setting will allow you to set the amount of time it takes for the headlights to shut off after the vehicle is turned off. The available settings are "0 sec", "30 sec", "60 sec", and "90 sec".
Headlights with Wipers	This setting will turn the headlights on when the wipers are activated.
Auto Dim High Beams	This setting will allow you to turn the Auto Dim High Beams on or off.
Daytime Running Lights	This setting will allow you to turn the Daytime Running Lights on or off.

Setting Name	Description
Flash Lights With Lock	This setting will allow you to turn the flashing of the lights when the Lock button is pushed on the key fob on or off.
Steering Directed Lights	This setting will turn the headlights with the steering wheel. The available options are "On" and "Off".

Brakes

After pressing the Brakes button on the touchscreen, the following settings will be available:

NOTE:

Depending on the vehicle's options, feature settings may vary.

Setting Name	Description
Auto Park Brake	This setting will turn the Auto Park Brake on or off.
Brake Service	This setting will allow you to retract the rear brakes for servicing.

Doors & Locks

When the Doors & Locks button is pressed on the touchscreen, the system displays the options related to locking and unlocking the vehicle's doors.

NOTE:

Depending on the vehicle's options, feature settings may vary.

Setting Name	Description
Auto Door Locks	This setting will allow you to change if the doors lock automatically when the vehicle reaches 15 mph (24 km/h).
Auto Unlock On Exit	This setting will unlock the doors when any of the doors are opened from the inside.
Flash Lights With Lock	This setting will allow you to turn the flashing of the lights when the Lock button is pushed on the key fob on or off.
Sound Horn With Lock	This setting will sound the horn when the Lock button is pushed on the key fob. The "Off" setting will not sound the horn when the Lock button is pushed. The "1st Press" setting will sound the horn when the Lock button is pushed once. The "2nd Press" setting will sound the horn when the Lock button is pushed twice.
Sound Horn With Remote Start	This setting will sound the horn when the remote start is activated from the key fob.
Remote Door Unlock, Door Lock/1st Press Of Key Fob Unlocks	This setting will change how many pushes of the Unlock button on the key fob are needed to unlock all the doors. The "Driver Door" setting will only unlock the driver door on the first push on the Unlock button. The "All Doors" setting will unlock all doors with only one push of the Unlock button.
Digital Keys	This setting will open the Digital Keys main screen, if equipped.
Passive Entry	This setting will allow you to turn the Passive Entry feature (Keyless Enter 'n Go™) on or off.
Power Tailgate	This setting will allow you to change the settings for the power tailgate. The selectable settings are "Manual" and "Power".

Seats & Comfort/Auto-On Comfort Systems

When Seats & Comfort/Auto-On Comfort Systems button is pressed on the touchscreen, the system displays the options related to the vehicle's comfort systems when remote start has been activated or the vehicle has been started.

NOTE:

Depending on the vehicle's options, feature settings may vary.

Setting Name	Description
Auto-On Driver Heated/Ventilated Seat & Heated Steering Wheel With Vehicle Start	This setting will activate the vehicle's comfort systems and heated seats or heated steering wheel when the vehicle is remote started or ignition is started. The "Off" setting will not activate the comfort systems. The "Remote Start" setting will only activate the comfort systems when using Remote Start. The "All Start" setting will activate the comfort systems whenever the vehicle is started.
Easy Exit Seats	This setting will automatically move the driver seat rearward when the engine is shut off. The available settings are "On" and "Off".

5

Key Off Options/Engine Off Options

When the Key Off Options/Engine Off Options button is pressed on the touchscreen, the system displays the options related to vehicle shutdown. These settings will only activate when the ignition is set to OFF.

NOTE:

Depending on the vehicle's options, feature settings may vary.

Setting Name	Description
Easy Exit Seat	This setting adjusts the seats to make exiting the vehicle easier.

Setting Name	Description
Headlight Off Delay	This setting will allow you to set the amount of time it takes for the headlights to shut off after the vehicle is turned off. The available settings are "0 sec", "30 sec", "60 sec", and "90 sec".
Auto Entry/Exit Suspension	This setting will turn the Auto Entry/Exit Suspension system on or off.
Radio Off Delay	This setting will keep the radio on for the selected amount of time after vehicle shut off. The available options are "0 sec", "45 sec", "5 min", and "10 min".
Radio Off With Door	This setting will keep the radio on when a door is opened or until the Radio Off Delay time is reached. The available settings are "On" and "Off".
Key Off Power Delay/Engine Off Power Delay	This setting will keep certain electrical features running after the engine is turned off. When any door is opened, the electronics will deactivate. The available settings are "0 sec", "45 sec", "5 min", and "10 min".

Suspension/Air Suspension

When the Suspension/Air Suspension button is pressed on the touchscreen, the system will display settings related to the vehicle's air suspension.

NOTE:

Depending on the vehicle's options, feature settings may vary.

Setting Name	Description
Sound Horn With Lower	This setting will sound the horn when the Lower button is pressed on the key fob.
Flash Lights With Lower	This setting will flash the lights when the Lower button is pressed on the key fob.

Setting Name	Description
Auto Entry/Exit Suspension	This setting will automatically lower the vehicle ride height for easier entry and exit. Selectable options are “On” and “Off”.
Display Suspension Messages	This setting will display suspension messages in the Instrument Cluster Display. The “All” setting will display all available messages. The “Warnings Only” setting will only display warning messages.
Aero Mode	This setting will automatically adjust the vehicle ride height depending on the vehicle speed.
Service Mode	This setting will disable the Air Suspension system to assist in changing a spare tire.
Auxiliary Mode	This setting will allow you to set the auxiliary suspension mode. The available options are “Off”, “Transport Mode”, and “Wheel Alignment Mode”. In Transport Mode, the vehicle will not auto level when being transported by another vehicle. In Wheel Alignment Mode, the vehicle will not auto level when a wheel alignment is being performed.
Default Ride Height	This setting will allow you to adjust the vehicle ride height. The available settings are “Normal” and “Aero”.
Four Corner Air Suspension Modes	There are three air suspension modes designed to protect the system in unique situations. Tire Jack Mode is selected to assist in changing a spare tire. Transport Mode is selected to assist when the vehicle is being flat bed towed. Wheel Alignment Mode is selected before performing a wheel alignment. Contact an authorized dealer for further information.

Audio

When the Audio button is pressed on the touchscreen, the system displays options related to the vehicle's sound system. These settings can change the audio location within the vehicle, adjust the bass or treble levels, and auto-play settings from an audio device or smartphone.

NOTE:

Depending on the vehicle's options, feature settings may vary.

Setting Name	Description
Balance/Fade	This setting will adjust audio levels from specific speakers in the front/back and left/right of the vehicle. The Speaker icon can be moved to set audio location.
Equalizer	This setting will adjust the "Bass", "Mid", and "Treble" ranges of the audio.
Speed Adjusted Volume	This setting will adjust audio volume as speeds increase. At a higher setting, the volume will increase more as the vehicle speeds up. The available settings are "Off", "1", "2", and "3".
Surround Sound	This setting will turn the Surround Sound system on or off.
AUX Volume Offset	This setting will tune the audio levels from a device connected through the AUX port. The available settings are "+" and "-".
Auto Play	This setting will automatically begin playing audio from a connected device.
Loudness	This setting will improve audio quality at lower volumes.

Notifications

When the Notifications button is pressed on the touchscreen, the system displays the options related to Notifications for the system.

NOTE:

Depending on the vehicle's options, feature settings may vary.

Setting Name	Description
Notification Sounds	This setting will turn off the Notification chime that plays when a new notification is sent. The options are "On" and "Off".
App Drawer Favoriting Pop-Ups	This setting turns the App Favorited pop-up on or off.
App Drawer Unfavoriting Pop-Ups	This setting turns the App Unfavorited pop-up on or off.
New Text Message Pop-Ups	This setting turns receiving/storing a pop-up for new text messages from any connected phone on or off.
Missed Calls Message	This setting turns receiving/storing a pop-up for missed calls from any connected phone on or off.
Navigation Pop-Ups	This setting turns receiving/storing predictive Navigation Pop-Ups on or off.

SiriusXM® Setup

When the SiriusXM® Setup button is pressed on the touchscreen, the system displays options related to SiriusXM® satellite radio. These settings can be used to skip specific radio channels and restart favorite songs from the beginning.

NOTE:

- A subscription to SiriusXM® satellite radio is required for these settings to be functional.
- Depending on the vehicle's options, feature settings may vary.

Setting Name	Description
SiriusXM® Account, Profile, And Settings	This setting will redirect you to the SiriusXM® Settings menu within the SiriusXM® menu.
Block Explicit	This setting will skip over content labeled as explicit. The available settings are “On” and “Off”.
Tune Start	This setting will play the current song from the beginning when you tune to a music channel using one of the 12 presets.
Channel Skip	This setting allows you to set channels that you wish to skip. A channel list will display of the skipped channels.
Subscription Information	This menu provides SiriusXM® subscription information.

Accessibility

When the Accessibility button is pressed on the touchscreen, the system will display the setting related to Accessibility.

NOTE:

Depending on the vehicle’s options, feature settings may vary.

Setting Name	Description
Video Button Readback	This setting will announce a function prior to performing the action selected when using DVD/Blu-ray™ functions. For example, when activated, and the Play button is selected, the system will announce “Play Button Selected”, and then once pressed again, the Play button will perform its action.

Software Updates

When the Software Updates button is pressed on the touchscreen, the system will display the setting related to updating the Uconnect software.

NOTE:

Depending on the vehicle's options, feature settings may vary.

Setting Name	Description
Software Downloads over Wi-Fi	This setting will allow software updates to happen over Wi-Fi. Selectable options for the setting are "On" and "Off".

System Information

When the Software Updates button is pressed on the touchscreen, the system will display the setting related to updating the Uconnect software.

NOTE:

Depending on the vehicle's options, feature settings may vary.

Setting Name	Description
Version Information	When this feature is selected, a Version Information screen will appear, displaying information about the version of your radio.
License Information	When this feature is selected, a License Information screen will appear, displaying the licensing information of your radio.
Passenger License Information	When this feature is selected, Passenger License Information is displayed.

Reset/Restore Settings To Default

When the Reset/Restore Settings To Default button is pressed on the touchscreen, the system displays the options related to resetting the Uconnect system back to its default settings. These settings can clear personal data and reset selected settings from other menus.

NOTE:

Depending on the vehicle's options, feature settings may vary.

Setting Name	Description
Restart Radio	This setting will reboot the radio.
Reset Apps Drawer To Default Order	This setting will return the apps drawer to the default order. The available options are "Yes" and "Cancel". The X button can also be pressed to cancel the screen.
Restore Settings to Default	This setting will return all the previously changed settings to their factory defaults.
Clear Personal Data	This setting will display a pop-up that gives you the option to clear all personal data from the system, including Bluetooth® devices and presets.
Reset Wi-Fi Password For Projection	This setting will allow you to reset the vehicle's Wi-Fi password for smartphone projection. The available options are "Yes" and "Cancel". The X button can also be pressed to cancel the screen.
Reset Performance Values	This setting will reset your vehicle's performance values.
Factory Reset	This setting will restore the radio to its factory default settings.

AUX Switches

When the AUX Switches button is pressed on the touchscreen, the system displays the options related to the six vehicle AUX switches.

NOTE:

Depending on the vehicle's options, feature settings may vary.

Setting Name	Description
AUX 1-6	This setting will adjust the type and power source for the six vehicle AUX switches. There are two types: "Latching" and "Momentary". The power source for the AUX switches can either be set to run off the "Battery" or from the "Ignition". In addition to setting the type and power source, you can set if the vehicle will recall the previous state at which the AUX switches were set. The Recalled Last State setting can be set to "On" or "Off". Last state conditions are met only if the type is set to Latching and the power source is set to Ignition.

STEERING WHEEL AUDIO CONTROLS

The remote sound system controls are located on the rear surface of the steering wheel at the three and nine o'clock positions.

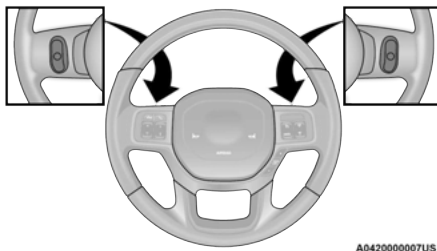

A042000007US

Remote Sound System Controls

The right-hand control is a rocker-type switch with a push button in the center and controls the volume and mode of the sound system. Pushing the top of the

rocker switch will increase the volume, and pushing the bottom of the rocker switch will decrease the volume.

Pushing the right-hand control's center button will make the radio switch between the various modes available (AM/FM/SXM or Media, etc.).

The left-hand control is a rocker-type switch with a push button in the center. The function of the left-hand control is different depending on which mode you are in.

The following describes the left-hand control operation in each mode:

RADIO OPERATION

Pushing the top of the switch will seek up for the next available station and pushing the bottom of the switch will seek down for the next available station.

The button located in the center of the left-hand control will tune to the next preset station that you have programmed in the radio presets.

MEDIA MODE

Pushing the top of the switch skips to the next track on the selected media (AUX/USB/Bluetooth®). Pushing the switch up twice will go forward two tracks. Pushing the bottom switch goes to the beginning of the current track, or the beginning of the previous track if it is within eight seconds after the current track begins to play. Double pressing the bottom button switch will skip to the previous track if it is after eight seconds into the current track.

PASSENGER SCREEN — IF EQUIPPED

Your vehicle may be equipped with a Passenger Screen located above the glove compartment on the passenger side of the vehicle. From the Passenger Screen, you will be able to access similar features seen within the Uconnect radio, such as media functions, Navigation, and device management.

To begin using the Passenger Screen, push the Power button to the left of the Passenger Screen display, or press the Power button under the Controls tab within

the Uconnect system. The Passenger Screen can be turned off by accessing the Control screen and pressing the Power Off button.

You must link Bluetooth® headphones to the Passenger Screen to begin listening to the system's audio.

NOTE:

The Passenger Screen will need to be turned On each time the vehicle is started, and the system will display the Home screen upon boot up.

PASSENGER SCREEN PERMISSIONS

Through the Uconnect system, features within the Passenger Screen can be activated and deactivated through Passenger Screen Permissions. To access Permissions, press the Vehicle button in the Menu Bar and select the Settings tab. Then, press the Passenger Screen Settings menu. Press the On button for the Passenger Screen Permissions setting to activate Permissions.



Passenger Screen Permissions Settings Menu

By default, the Passenger Screen Permissions setting is set to "Off", and the driver will need to give permission for the different features.

When Permissions is turned "On", you can individually select the permissions for the followings:

- Navigation
- Device Manager
- Rear Seat Entertainment — If Equipped

Passenger Screen Permissions can also be activated through the Controls screen, under the Vehicle button in the Menu Bar. If "Deny Passenger Screen Permissions" is turned "On", the setting will switch itself to "Off".

HOME SCREEN

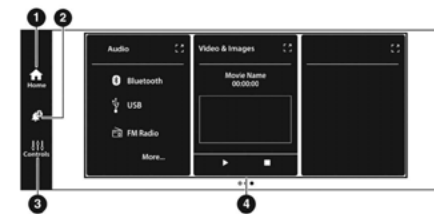

Passenger Screen Home Screen

- 1 — Home Screen Button
- 2 — Notifications Button
- 3 — Controls Button
- 4 — Feature Cards

When the Passenger Screen is started up and no other media was running previously, the Home screen will display. Here, you can select from the features of the Passenger Screen. On the left side of the screen, you can access “Notifications and System Controls”.

The Notifications button (the bell) will take you to the Notifications screen, identical to what is seen in the main radio.

You can cycle between the features by swiping left or right on the touchscreen. When accessing a feature, press the Home button on the left side to access the feature view and select a different feature.

The available features are:

- Audio
- Video & Images
- HDMI
- Rear Seat Entertainment — If Equipped
- Navigation
- Devices
- Cameras

Controls Screen

From the Controls Screen, you can adjust the daytime/nighttime brightness of the screen, change headphone volume, and power off the Passenger Screen.

To change the brightness, adjust the slider up or down, or press the Up or Down Arrow button located next to the slider. “Up” will increase brightness; “Down” will decrease brightness. Daytime and nighttime brightness levels will vary, and the adjustment

maximum/minimum will differ depending on the time of day.

To change the headphone volume, adjust the slider up or down, or press the Up or Down Arrow button located next to the slider. “Up” will increase the volume; “Down” will decrease the volume.

NOTE:

Headphone volume can also be manually adjusted from the headphones. Changing the headphone volume manually will not reflect in the headphone volume slider on the Passenger Screen.

If the Screen Off button is pressed, the Passenger Screen will continue to operate, but the screen will go dark. Tap the screen again to return to the display. While the screen is off, audio will continue to play from the Passenger Screen.

The Power Off button will fully shut down the Passenger Screen. No audio or video will play from it.

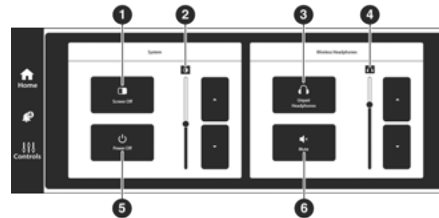

Passenger Screen Controls Screen

- 1 — Screen Off
- 2 — Display Brightness
- 3 — Manage Headphones
- 4 — Headphone Volume
- 5 — Power Off
- 6 — Mute Headphones

AUDIO AND VIDEO



Audio Feature

- 1 — All Sources Tab
- 2 — Now Playing Tab
- 3 — Browse Tab

Audio allows you to listen to your favorite radio station, a connected USB device, or connected media device. You can directly change the source on the Home screen by pressing the Source button in the feature. You can also expand it by pressing the Full Screen View button.

To change the media source, press the Source button and then press on the desired source. The available sources are:

- Live Radio (FM, AM, SXM)
- Bluetooth®
- USB 1
- USB 2
- AUX
- AV 1 — If Equipped
- AV 2 — If Equipped
- Rear Screen 1 Listen In — If Equipped
- Rear Screen 2 Listen In — If Equipped

NOTE:

- Audio devices connected via Bluetooth® must be done through the Device Manager in the radio. For more information on pairing a device, refer to your Uconnect Radio Instruction Manual.
- If the driver is listening to “Live Radio”, the option will not be available in the Passenger Screen. Select “Now Playing On Radio” to listen to the currently playing station. If the driver selects a radio station while the Passenger Screen is playing live radio content, the feed will end on the Passenger Screen and control will be given to the Uconnect system.

On the Preset menu, you will be able to listen to saved radio presets. Press the desired preset to begin listening.

The Browse tab will let you browse through different radio stations or audio saved onto a USB or audio device. Press “Browse” and select from the different

folders. You can scroll up and down to view the options within those folders. Press on the desired radio station or audio track to begin playing it.

When the USB source is selected, you can chose a video file to play if saved to a USB device. Press “Browse” and locate the folder with the video file. Press the video file name, and it will begin to play on the Passenger Screen.

NOTE:

Not all video files will be supported from a USB. Certain video files may require digital rights to view or play. These may be unavailable for playback on the Passenger Screen.

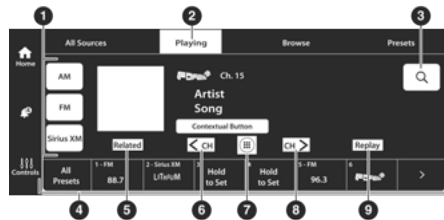

Playing A Video

- 1 — Source Bar
- 2 — Now Playing Tab
- 3 — Browse Button
- 4 — Preset Bar
- 5 — Related Button
- 6 — Seek Down Button
- 7 — Tune Button
- 8 — Seek Up Button
- 9 — Replay Button

HDMI PROJECTING

HDMI lets you connect a device to the provided HDMI port, using an HDMI cable, and project the device directly to the Passenger Screen. To begin, plug a device into the HDMI port. Then, press the HDMI button on the touchscreen.

HDMI will continue to show the menu bar and Headphone Pairing button.

NOTE:

- The HDMI Card will not automatically launch when a new device is connected. The HDMI Card will show a device connected, and the Card will need to be pressed.
- If the user disconnects a device from the HDMI port while the HDMI Card is in full screen, the system will close HDMI and reload the Home screen.

DEVICE MANAGER

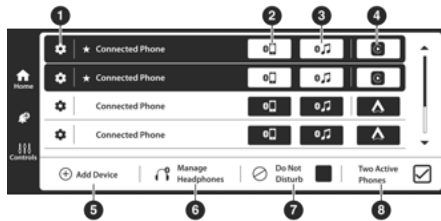

Device Manager

- 1 — Device Settings Button
- 2 — Phone Connectivity Button
- 3 — Media Connectivity Button
- 4 — Android Auto™/Apple CarPlay® Button
- 5 — Add Device Button
- 6 — Manage Headphone Button
- 7 — Do Not Disturb Button
- 8 — Two Active Phones Button

Device Manager provides an easy place to view all the devices connected to the Uconnect system and lets you pair the Driver's smartphone to the Uconnect system. You will also pair Bluetooth® headphones to the Passenger Screen from this screen.

For more information on pairing your smartphone, refer to your Uconnect Radio Instruction Manual.

To pair a set of Bluetooth® Headphones:

1. If viewing Device Manager in full screen, press the Add Device button. If viewing Device Manager on the Home screen, press "Pair Bluetooth® headphones".
2. From the pop-up, press "Search For Headphones". The system will begin searching for the Bluetooth® signal of your headphones.
3. Select the name of your headphones from the list of possible devices. The system will connect to the headphones.

NOTE:

The Passenger Screen will connect to previously paired Bluetooth® headphones after Passenger Screen activation.

Removing Bluetooth® Headphones

1. From the Controls screen, press the Manage Headphones button.
2. Press the Settings button (gear icon) next to the set of headphones you wish to remove.
3. Press "Delete Device"; the Bluetooth® headphones will be removed from the system.

NAVIGATION

Navigation allows you to assist the driver in searching for destinations using Uconnect's built-in Navigation system. For information on the full functionality of Navigation, refer to your Uconnect Radio Instruction Manual.

When a new route is selected from the Passenger Screen, a confirmation will be sent to the driver. The driver will be able to confirm or deny the route.

NOTE:

Using Navigation on the Passenger Screen will not affect the Navigation screen in the Uconnect system. The Driver can continue to use Navigation while the Passenger Screen can "suggest" new routes or stops.

CAMERA

Camera will display the equipped vehicle camera feed. When selected, press the desired Camera button. The feed from that camera will display in the center of the touchscreen. Press the X button or Back Arrow button to return to the Home screen.

NOTE:

The Passenger Screen will lose access to a camera if the driver chooses to view it on the Uconnect system or if a condition would activate the camera on the Uconnect system (the rearview camera being activated when the vehicle is shifted into REVERSE).

PERFORMANCE PAGES — IF EQUIPPED

Performance Pages is an application that provides a display for performance indicators that will help you gain familiarity with the capabilities of your vehicle in real time.

To access the Performance Pages, press the Vehicle button on the touchscreen. Then, press the Performance tab. Press the desired button on the touchscreen to access that specific Performance Page.

WARNING!

Measurement of vehicle statistics with the Performance Pages is intended for off-highway or off-road use only and should not be done on any public roadways. It is recommended that these features be used in a controlled environment and within the limits of the law. The capabilities of the vehicle as measured by the Performance Pages must never be exploited in a reckless or dangerous manner, which can jeopardize the user's safety or the safety of others. Only a safe, attentive, and skillful driver can prevent accidents.

The Performance Pages include the following:

- Timers
- Gauges
- G-Force
- Pitch & Roll
- Dyno/Engine
- Vehicle Dynamics

Snapshot

The Snapshot feature allows you to take a screenshot of any page. The information can be saved onto a USB device.

To take a snapshot, make sure a USB device is plugged into the vehicle. Next, press the Snapshot icon located in the lower left corner of the touchscreen.

The file will be saved to the USB drive. At the time a snapshot is taken, the bottom bar of the touchscreen will be replaced with the historical data from the vehicle

present at the time the snapshot icon was pressed. The following information will display:

- Date
- Vehicle Identification Number (VIN)
- Longitude And Latitude Coordinates
- Outside Temperature
- Odometer

The following describes each feature and its operation:

TIMERS

When the Timers page is selected, you will be able to view the Drag and Accel & Braking timers.

● Recent

A real-time summary of performance timers for the most recent valid run, or the status of a test in progress.

● Last

The last recorded run of performance timers.

● Best

The best recorded run of performance timers, except for braking data.

Save

Pressing the SAVE button will let you save the timer data for Recent, Last, and Best recorded times to an inserted USB flash drive.

The Timers pages contain:

- **Reaction Time:** Measures the driver's reaction time for launching the vehicle against a simulated drag strip timing light (behavior modeled after 500 Sportsman Tree) displayed in the instrument cluster display.

NOTE:

Drag timers (RT, 60 ft [20 m], 330 ft [100 m], 1/8 mile [200 m], 1000 ft [300 m], and 1/4 mile [400 m]) and Acceleration Timers (0-60 mph [0-96 km/h] and 0-100 mph [0-160 km/h]) will be ready to acquire new recent data measurements when the vehicle is at 0 mph (0 km/h) and vehicle is in drive.

The timer listed shows the measured time required to travel at the cited distance is met. Some timers will also display speeds present at the time the distance was met.

- 0-60 mph (0-100 km/h)
- 0-100 mph (0-160 km/h)
- 60 ft (20 m) ET
- 330 ft (100 m) ET
- 1/8 mile (200 m) + ET
- 1/8 mile (200) + mph
- 1000 ft (300 m) ET
- 1/4 mile (400 m) + ET
- 1/4 mile (400 m) + mph
- Brake Distance ft (meters)

NOTE:

The distance measurement will be aborted if the brake pedal is released or the parking brake is engaged, before the vehicle comes to a complete stop.

- Brake from mph (km/h)

NOTE:

Brake Distance and Speed timers only display “ready” when vehicle is traveling at a speed greater than 30 mph (48 km/h).

GAUGES

When selected, this screen displays the following values:

- Coolant Temperature
Shows the actual coolant temperature.
- Oil Temperature
Shows the actual oil temperature.
- Oil Pressure
Shows the actual oil pressure.
- Trans Temp
Shows actual transmission oil temperature.
- Battery Voltage
Shows actual battery voltage.
- Intake Air Temp
Shows actual intake air temperature.

If a gauge is selected, the Gauge Detail View Page will appear on the screen. This page shows gauge values for the previous two minutes on the selected gauge.

Pressing the Left or Right Arrow will cycle through the details for each of the gauges. Pressing the minimize button beside the graph will return to the Gauge menu.

G-FORCE

When G-Force is selected, the following features will be available:

- Vehicle Speed
Measures the current speed of the vehicle in either mph or km/h, starting at zero with no maximum value.
- Front G-Force
Measures the peak braking force on the front of the vehicle.
- Right G-Force
Measures the peak force on the right side of the vehicle.
- Left G-Force
Measures the peak force on the left side of the vehicle.
- Rear G-Force
Measures the peak acceleration force on the rear of the vehicle.

NOTE:

Front, Right, Left, and Rear G-Forces are all peak values. These readings can be reset by clearing peak G-Force on the instrument cluster.

The friction circle display shows instantaneous G-Force as a highlight and previous G-Force as dots within the circle. The system records previous G-Force for three minutes. If there are multiple samples at a given point, the color of the dot will darken from blue to red. Vectors more frequent will show in red; infrequent vectors will show in blue.

Pitch & Roll

The G-Force page displays the vehicle's current pitch (angle up and down) and roll (angle side to side) in degrees. The Pitch & Roll gauges provide a visualization of the current vehicle angle.

DYNAMOMETER (DYNO)/ENGINE**Dynamometer (Dyno)**

The system will start drawing graphs for Power and Torque (top chart) and Engine Speed (bottom chart). The graph will fill from the left side of the x-axis and fill to the right side of the x-axis (based on History time selected). Once the right side of the page is reached, the graph will scroll with the right side always being the most recent recorded sample.

The following options can be selected:

- Press the STOP button to freeze the graph. Select “Play” to clear the graph and restart the process.
- Press the + or - button to change the history of the graph. The selectable options are “30”, “60”,

“90”, and “120” seconds. The graph will expand or constrict depending on the setting selected.

- Select the “Gear” display setting to turn the graph gear markers on or off.

NOTE:

The Gear On/Off feature will only display if your vehicle is equipped with an Automatic Transmission.

Engine

Press the Left and Right Arrow buttons on the bottom of the touchscreen to cycle between the Dyno and Engine pages.

When selected, this screen displays the following values:

- **Vehicle Speed:** Shows the actual vehicle speed.
- **Engine Power:** Shows the instantaneous power.
- **Engine Torque:** Shows the instantaneous torque.
- **Boost Pressure:** Shows the actual engine boost pressure.
- **Gear:** Shows the current (or pending) operating gear of the vehicle.

VEHICLE DYNAMICS

The Vehicle Dynamics page displays information concerning the vehicle’s drivetrain.

Steering Angle — If Equipped

Steering Angle utilizes the steering angle sensor to calculate the degree of the steering relative to zero (straight ahead) reference angle. The zero degree

reference angle measurement indicates the actual front tire steering angle.

Transfer Case

This feature will be active when the vehicle is in 4WD HIGH, 4WD AUTO, Neutral, or 4WD LOW.

NOTE:

A lock symbol will only be present on the Transfer Case button when the vehicle is in 4WD LOW.

Rear Axle Locker

This feature will allow you to lock and unlock the rear axle. To change the status, push the AXLE LOCK button.

DRIVE MODES

Your vehicle is equipped with On-Road and Off-Road Drive Modes features which allow for coordinating the operation of various vehicle systems depending upon the type of driving behavior desired. The Drive Modes feature is controlled through the touchscreen and may be accessed by performing any of the following:

- Pressing the Drive Modes button within the Dashboard tab within the Vehicle menu on the touchscreen.
- Pushing the RHO switch on the instrument panel will bring up the RHO vehicle features list on the head unit, where the Drive Modes interface can be selected. Double pushing the RHO button will engage the Custom Drive Modes and launch the Custom Drive Modes page.
- Pushing the Left or Right Arrow button under the RHO button on the instrument panel.

NOTE:

Pressing the Left or Right Arrow button will let you switch between the different modes. Switching between the different modes will also reflect in the instrument cluster display. If the Drive Mode’s interface is already open on the touchscreen, and the << or >> button is pressed, the Drive Mode’s mode that was selected on the instrument cluster will appear on the touchscreen. For more information on the instrument cluster display and its interaction with Drive Modes → page 116.

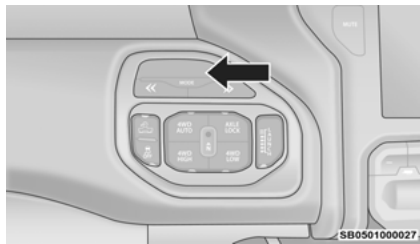

Drive Modes Button

The Drive Modes main screen displays the current drive mode and real-time status of the vehicle’s performance configuration. The selectable Drive Modes are “Sport”, “Tow”, “Snow”, “Auto”, “Custom”, “Mud/Sand”, “Rock”, and “Baja”. Information shown will indicate the actual status of each system, along with a vehicle graphic that displays the active Drive Modes status. The color red indicates “Sport,” yellow for “Street”, light blue for “Snow”, purple for “Tow”, and orange for “Baja”. These features will reset to its AUTO Drive Modes configuration upon an ignition cycle if the transfer case

is in 4WD AUTO or 4WD HIGH. In 4WD LOW, after an ignition cycle, the Drive Modes will return to the mode that was active when the vehicle was last turned off. If the system status shown does not match the current Drive Mode Set-Up, a message will be displayed indicating which values are not matching the current mode.

NOTE:

- Sport and Tow Modes Set-Up menus cannot be changed.
- Some parameters within Snow, Auto, Mud/Sand, Rock, and Baja Modes Set-Up menus can be configured.
- All subsystems within the Custom Mode Set-Up screen (with the exception of Rock Stability) can be configured.

ON-ROAD

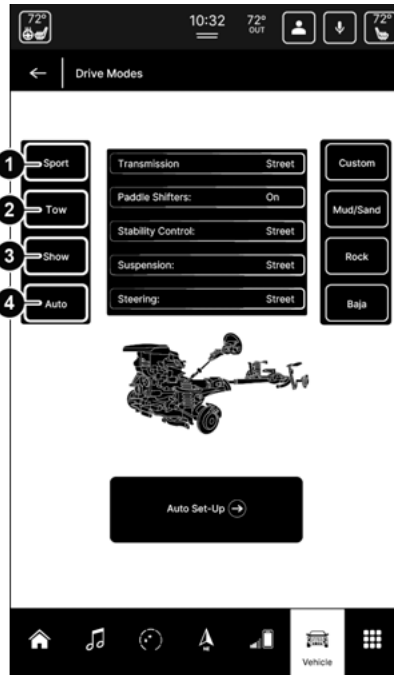

On-Road Drive Modes

- 1 – Sport
- 2 – Tow
- 3 – Snow
- 4 – Auto

Sport Mode

Selecting “Sport” on the touchscreen will activate the configuration for typical enthusiast driving. The Transmission, Stability Control, Steering, and Suspension systems are all set to their Sport settings highlighted in red. The paddle shifters are enabled.

NOTE:

Sport Mode is not available if the transfer case is in 4WD LOW.

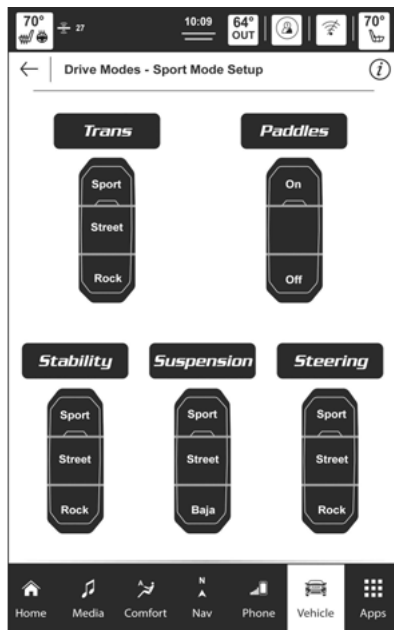

Sport Mode Set-Up

Tow Mode

Selecting "Tow" on the touchscreen will activate the configuration for towing a trailer or hauling heavy loads in the cargo area. Once in this mode, trailer sway control is enabled in the Electronic Stability Control

(ESC) system. The Transmission is set to Tow, Stability Control is set to Full, Steering is set to Street, and Suspension is set to Tow. Paddle shifters are enabled.

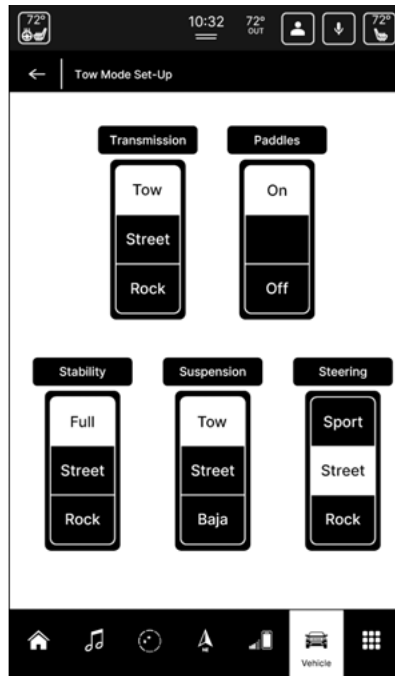

Tow Mode Set-Up

Snow Mode

Selecting "Snow" on the touchscreen will activate Snow Mode for use on loose traction surfaces. When in Snow Mode (depending on certain operating conditions), the transmission will shift earlier than in other modes, which will keep wheel torque low to minimize wheel slippage. The Transmission is set to Snow, Stability Control is set to Full, and Steering and Suspension are set to Street. Paddle shifters are defaulted to "On" but are configurable.

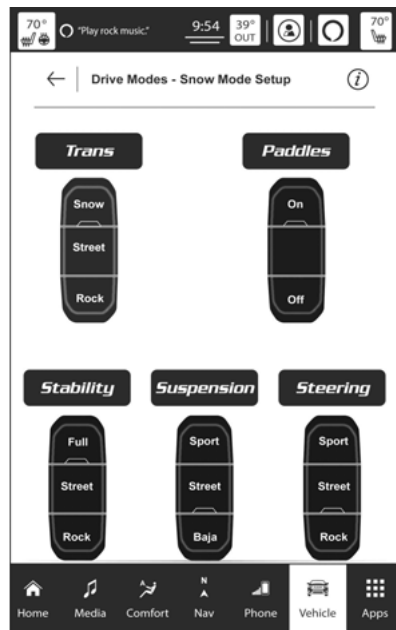

Snow Mode Set-Up

Auto Mode

Auto Mode is enabled upon ignition ON while in 4WD AUTO or 4WD HIGH or by selecting "Auto" on the touchscreen. The Transmission, Stability Control,

Suspension, and Steering are all set to Street. Paddle shifters are enabled.

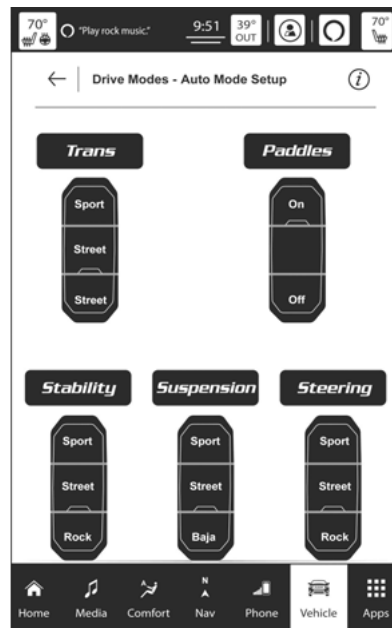

Auto Mode Setup

Off-Road

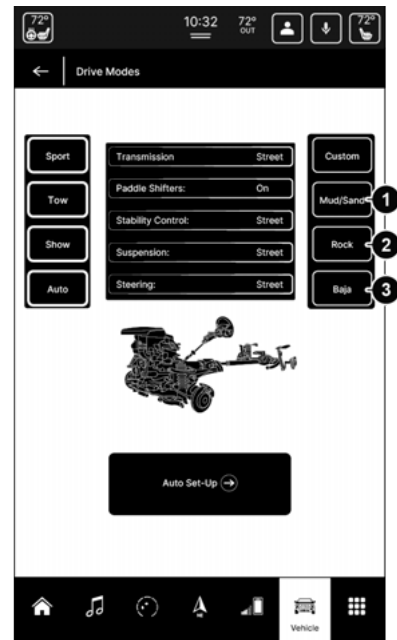

Off-Road Drive Modes

- 1 — Mud/Sand
- 2 — Rock
- 3 — Baja

Mud/Sand

Selecting “Mud/Sand” on the touchscreen will activate Mud/Sand Mode for use on mud and sand-like conditions. Transmission is set to Sport, Stability is set to Sport, Suspension is set to Baja, and Steering is set to Rock. Paddle shifters are enabled.

Rock

Selecting “Rock” on the touchscreen will activate Rock Mode for use on rocky surfaces. Transmission and Stability are set to Sport. Steering is set to Rock. Suspension is set to Tow. Paddle shifters are enabled.

NOTE:

The vehicle must be in 4WD LOW to access Rock Mode.

Baja

Selecting “Baja” on the touchscreen will activate Baja Mode for high-speed off-road driving. Transmission, Suspension, and Stability are set to Baja. Steering is set to Sport. Paddle shifters are enabled.

NOTE:

Baja Mode is not available in 4WD LOW.

CUSTOM MODE

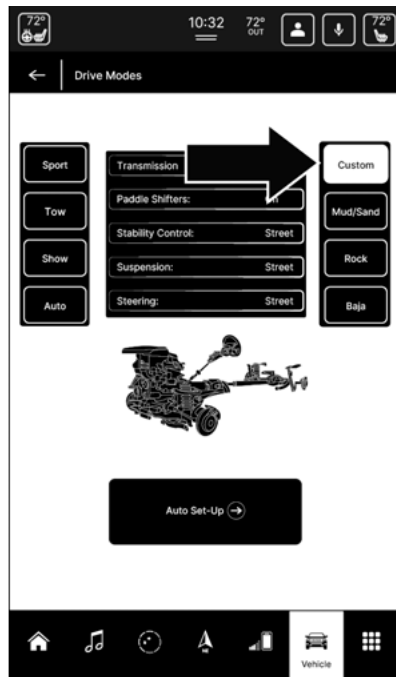

Drive Modes (Custom)

Custom Mode may be selected by pressing the Custom button on the touchscreen or by pushing the RHO button twice within two seconds. Custom Mode allows you to create a custom configuration that is saved for quick selection of your favorite settings. While in Custom Mode, the Transmission, Paddles, Steering, Stability, and Suspension settings are shown in their current configuration.

While on the Custom Mode screen, press the Custom Setup button on the touchscreen to access the set-up page options. Select which mode suits your driving needs for a custom driving experience.

Drive Mode Set-Up Info

Within the Drive Mode Set-Up screen, press the Info button on the touchscreen then use the Left/Right arrow towards the bottom of the touchscreen to scroll through all the available Drive Mode systems giving you a description of their operation and current configuration.

NOTE:

Not all levels are adjustable in each Drive Mode Set-Up.

Transmission

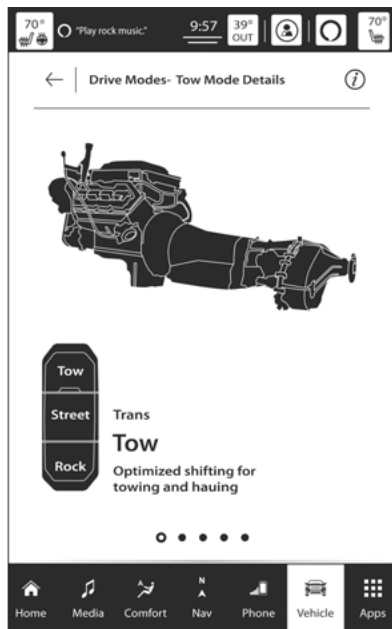

Transmission

- **Sport:** Faster shift speeds with some comfort trade-off.
- **Tow:** Optimizes shifting for towing and hauling.
- **Snow:** Optimizes shifting for low-traction conditions.
- **Street:** A balance of shift speed and comfort for typical daily driving.
- **Baja:** Performs aggressive shifting for off-road performance.
- **Rock:** Optimized shifting for traversing rocky terrain.

Paddle Shifters

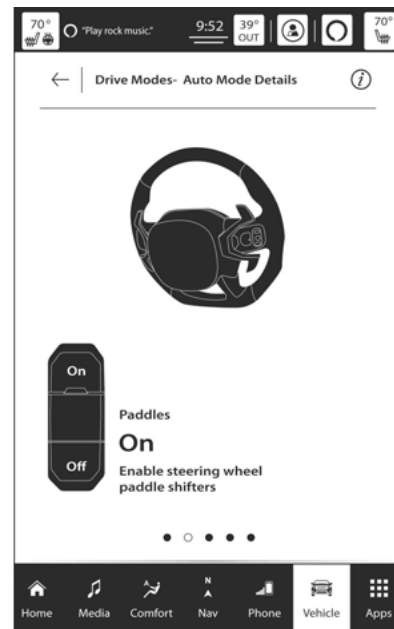

Paddle Shifters

- **On:** Enables steering wheel paddle shifters.
- **Off:** Disables steering wheel paddle shifters.

Stability Control

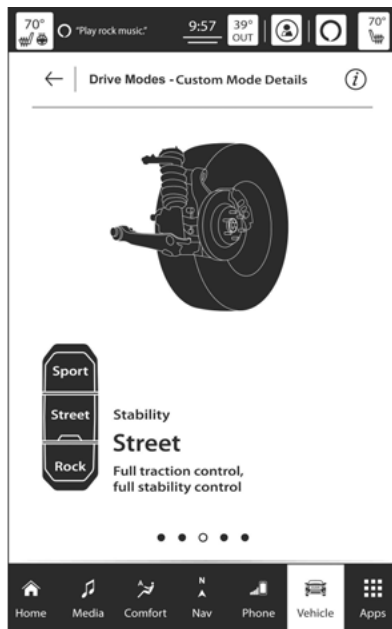

Stability Control

- **Sport:** Provides reduced stability control.
- **Street:** Provides street stability control optimized for daily driving.
- **Full:** Provides traction control and stability control optimized for slippery conditions.
- **Baja:** Optimizes the Anti-Brake System (ABS), traction control, and stability control for high-speed off-road driving.
- **Rock:** Optimizes traction control for low-speed off-road driving/crawling.

Suspension

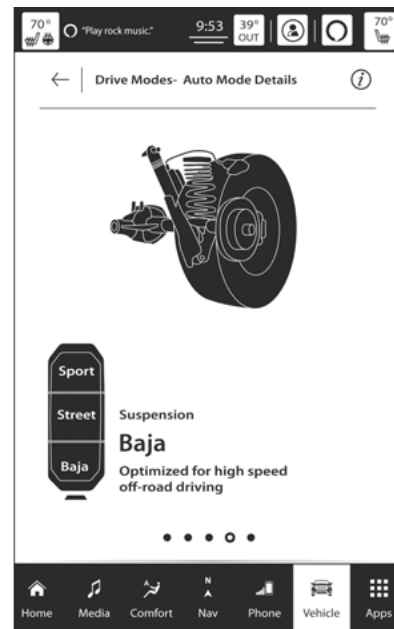

Suspension

- **Sport:** Provides a firmer suspension stiffness with moderate comfort trade-off.

- **Street:** Provides a balance of suspension stiffness and ride comfort for typical daily driving.
- **Baja:** Optimizes for high-speed off-road driving.

Steering

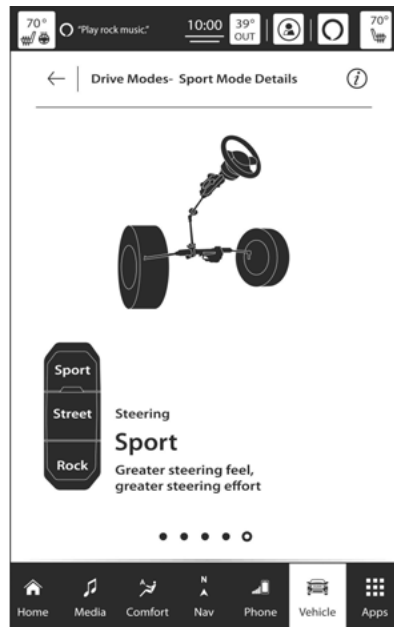

Steering

- **Sport:** Adjusts the steering effort and feel to a greater level.
- **Street:** Balances the steering feel and comfort.
- **Rock:** Provides the greatest steering feel and lowest effort for improved control.

RACE OPTIONS

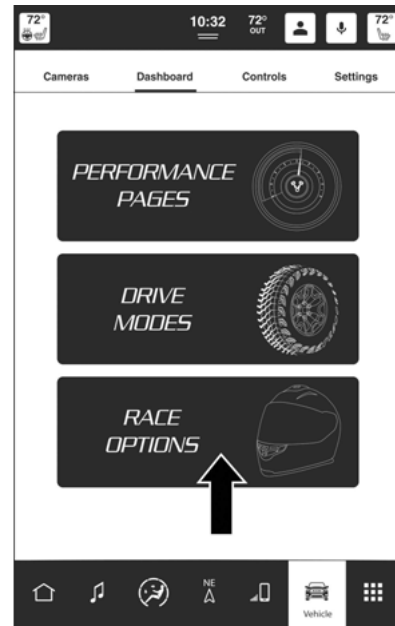

Race Options

Press the Race Options tab on the touchscreen to display the vehicle's Launch Control screen. Within Race Options, you can activate, deactivate, and adjust

the RPM values for the Launch Control, Race Cooldown, and Shift Light features → page 271.

Launch Control

WARNING!

Launch Control is intended for off-highway or off-road use only and should not be used on any public roadways. It is recommended that this feature be used in a controlled environment, and within the limits of the law. The capabilities of the vehicle as measured by the performance pages must never be exploited in a reckless or dangerous manner, which can jeopardize the user's safety or the safety of others. Only a safe, attentive, and skillful driver can prevent accidents.

This vehicle is equipped with a Launch Control system that is designed to allow the driver to achieve maximum vehicle acceleration in a straight line. Launch Control is a form of traction control that manages tire slip while launching the vehicle. This feature is intended for use during race events on a closed course where consistent 1/4-mile and 0-to-60 times are desired. The system is not intended to compensate for lack of driver experience or familiarity with the race track. Use of this feature in low traction (cold, wet, gravel, etc.) conditions may result in excess wheel slip outside this systems control resulting in an aborted launch.

Preconditions:

- Launch Control should not be used on public roads. Always check track conditions and the surrounding area.
- Launch Control is not available within the first 500 miles (805 km) of engine break-in.
- Launch Control should only be used when the engine and transmission are at operating temperature.
- Launch Control is intended to be used on dry, paved road surfaces only.
- Launch Control will not be available when in 4WD LOW or while operating in Valet Mode.

Launch Control is only available when the following procedure is followed:

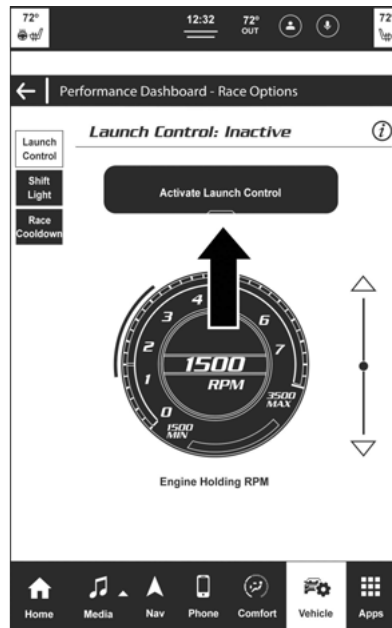

Activate Launch Control

- Adjust your launch RPMs for optimum launch/traction, if required.
 - Press the Activate Launch Control button on the touchscreen or press the Launch button on the instrument panel; follow instructions on the instrument cluster display.
 - Make sure the vehicle is not moving.
 - Put vehicle in first gear or Drive.
 - Steering wheel must be centered with tires pointing forward.
 - Vehicle must be on level ground.
 - Apply brake pressure.
 - While holding the brake, rapidly apply and hold the accelerator pedal to wide open throttle. The engine speed will hold at the RPM that was set in the "Launch Control" screen.
- NOTE:**
Messages will appear in the instrument cluster display to inform the driver if one or more of the conditions have not been met.
- When the conditions have been met, the instrument cluster display will read "Release Brake".
 - Keep the vehicle pointed straight and release the brake.

Launch Control will be active until the vehicle reaches 62 mph (100 km/h), at which point the Electronic Stability Control (ESC) system will return to its current ESC mode.

Launch Control will abort before launch completion and will display "Launch Aborted" in the cluster under any the following conditions:

- The accelerator pedal is released during launch.
- The ESC system detects that the vehicle is no longer moving in a straight line.
- The ESC Off button is pressed to change the system to another mode.

NOTE:

The Launch Control RPM setting can only be adjusted while Launch Control is not active. After Launch Control has been aborted, ESC will return to its current ESC mode.

CAUTION!

Do not attempt to shift when the drive wheels are spinning and do not have traction. Damage to the transmission may occur.

To adjust the Launch RPM, drag the slider bar or press the arrows on the touchscreen to adjust the holding RPM. The launch RPM limit is between the minimum and maximum RPM values shown on the gauge, in 100 RPM increments.

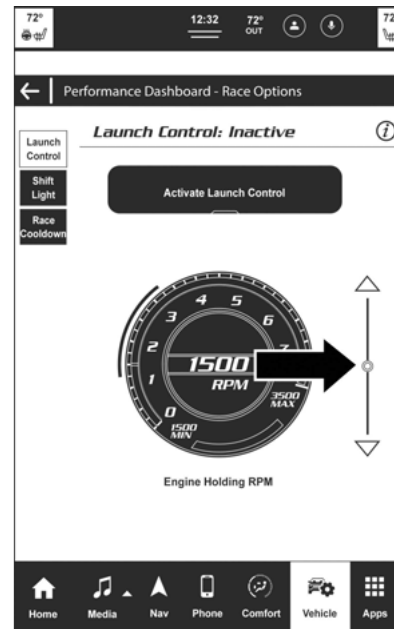

Launch RPM Set-Up

Shift Light

Your vehicle is equipped with a Shift Light feature that illuminates the instrument cluster display as a visual cue to manually upshift using the paddle shifters or shifting the transmission gear selector.

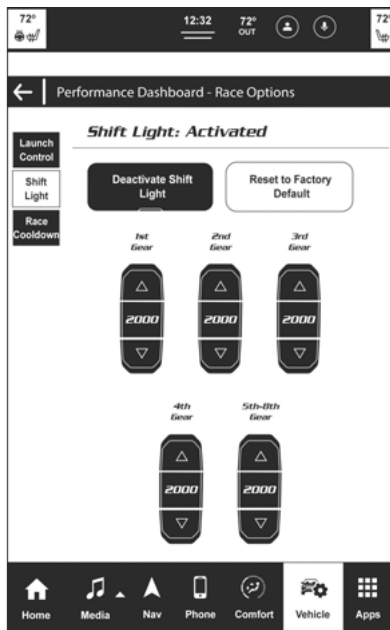

Shift Light Button

To actuate the Shift Light feature, press the Race Options tab, then press the Deactivate Shift Light button on the touchscreen. Activation is shown on the instrument cluster display.

Shift Light is only active when the gear selector is in Autostick or Sport position.

NOTE:

Paddle shifters can be used to shift, however using the paddle shifters while the shifter is in Drive (D) position will not enable the Shift Light feature.

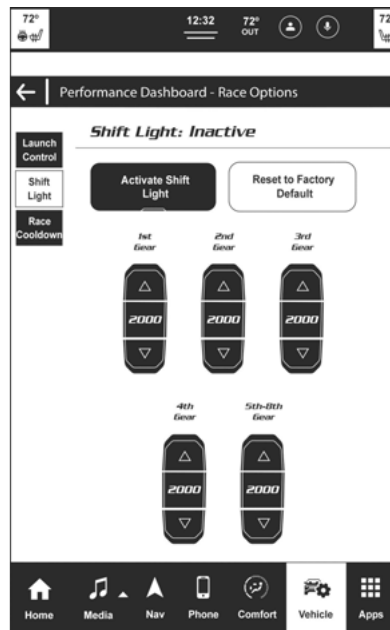

Shift Light RPM Set-Up

The Shift Light RPM Set-Up allows you to set the Shift Light to illuminate for gears 1, 2, 3, 4, and 5-8. Pressing and releasing the Up/Down Arrow buttons above and below each listed gear, the RPM values will change in increments of 250 RPM. Pressing and holding the arrows will change the RPM values in increments of 500 RPM, up to 6250 RPM. Press the Reset to Factory Default button on the touchscreen to change back to factory settings, or press the Deactivate Shift Light button on the touchscreen to turn the system off completely.

Race Cooldown

Race Cooldown is a selectable After-Run Cooling feature.

Race Cooldown is a feature activated by selecting the Race Cooldown button under the Race Options tab.

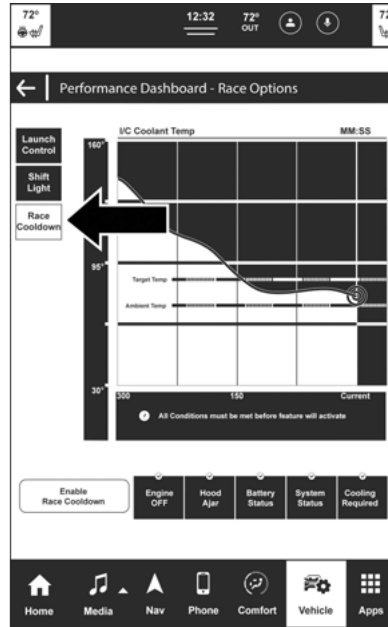

Race Cooldown Button

To enable this feature, the vehicle will check to ensure the engine is off, the hood is closed, the status of the battery and system are acceptable and determine if cooling is required.

After completing an event that has generated a lot of heat in the powertrain, this feature helps cool the vehicle after the engine has been shut down. The radiator fan and low temperature radiator coolant pump remain on after engine shutdown for a period up to five minutes or until target temperature is reached.

A graph in the radio can show the resulting intercooler coolant temperature in real time while the vehicle ignition is in ON/RUN position with the engine off.

NOTE:

Race Cooldown feature (After-Run) will only come on with the engine off. The temperature will display with engine running also, but After-Run Cooling will not be functioning.

This feature will automatically deactivate after extended driving at road speeds, or when one or more of the following conditions apply:

- If coolant temperature reaches the target temperature and cooling is no longer required.
- If battery voltage or state of charge drops below a threshold.
- If the hood is opened.

GUIDELINES FOR TRACK OR EXTREME OFF-ROAD USE

- If your vehicle is equipped with Drive Modes, they will alter the vehicle's performance in various driving situations. It is recommended that your vehicle operates in Sport or Baja Mode during the event.
- Prior to each event, verify all fluids are at the correct levels.

- Prior to each event, verify the front and rear brake pads have more than half pad thickness remaining. If the brake pads require changing, complete a brake burnish procedure prior to an event at full pace.
- At the conclusion of each event, it is recommended that a brake bleed procedure is performed to maintain the pedal feel and stopping capability of your brake system.
- It is recommended that each event outing should end with a minimum of one cooldown lap using minimal braking.
- All vehicles are severe use tested for 24 hours of endurance. However, it is recommended that the suspension system, brake system, prop shaft, and half shaft boots be checked for wear or damage after every event.
- Aggressive usage results in increased operating temperatures of the engine, transmission, driveline, and brake system. This may affect Noise Vibration Harshness (NVH) countermeasures of your vehicle. New components may need to be installed to return the system to the original NVH performance.
- Tire pressure:
 - Recommended tire pressure of 25 psi (172 kPa) when tires are cold, or below 38 psi (262 kPa) when hot.

NOTE:

It is recommended that you target below 38 psi (262 kPa) when tires are hot at the conclusion of each session. Starting at 25 psi (172 kPa) cold and adjusting based on ambient and conditions is recommended. Tire pressure can be monitored

via the instrument cluster display and can assist with adjustments.

VALET MODE

To enter Valet Mode, press the Valet Mode button from the All Profiles menu on the touchscreen. For more information on Profiles, please refer to your Uconnect Owner's Manual Supplement.

While in Valet Mode, the following vehicle configurations are set and locked to prevent unauthorized modification:

- Transmission upshifts earlier than normal.
- Steering and Suspension are set to their Street settings.
- Steering wheel paddle shifters are disabled.
- The ESC Off button is disabled.
- The Launch Control button is disabled.
- Engine power is reduced.

When the vehicle is started or was previously placed in Valet Mode, a pop-up will display that the vehicle is in Valet Mode. Select "Yes" to deactivate valet mode. Alternatively, press the Locked Profile icon in the Upper Status Bar to exit Valet Mode.

Enter your four-digit Valet Mode PIN and press "Go". Valet Mode will be deactivated. The Uconnect system will load the last active Profile before the vehicle was placed in Valet Mode.

NOTE:

If your four-digit PIN is lost or forgotten, the vehicle will exit Valet Mode after a battery disconnect for

approximately five minutes. Reconnect the battery and cycle the ignition to the ON/RUN position. The vehicle will be in Auto Mode.

RADIO OPERATION AND MOBILE PHONES

Under certain conditions, the mobile phone being on in your vehicle can cause erratic or noisy performance from your radio. This condition may be lessened or eliminated by repositioning the mobile phone within the vehicle. This condition is not harmful to the radio. If your radio performance does not satisfactorily improve from repositioning the mobile phone, it is recommended that the volume be turned down or off during mobile phone operation when not using the Uconnect system.

REGULATORY AND SAFETY INFORMATION**US/CANADA****Exposure to Radio Frequency Radiation**

The radiated output power of the internal wireless radio is far below the FCC and IC radio frequency exposure limits. Nevertheless, the wireless radio will be used in such a manner that the radio is 8 inches (20 cm) or further from the human body.

The internal wireless radio operates within guidelines found in radio frequency safety standards and recommendations, which reflect the consensus of the scientific community.

The radio manufacturer believes the internal wireless radio is safe for use by consumers. The level of energy emitted is far less than the electromagnetic energy emitted by wireless devices such as mobile phones.

However, the use of wireless radios may be restricted in some situations or environments, such as aboard airplanes. If you are unsure of restrictions, you are encouraged to ask for authorization before turning on the wireless radio ➞ page 422.

OFF-ROAD PAGES — IF EQUIPPED

Your vehicle may be equipped with Off-Road Pages which display vehicle information related to the drivetrain, transfer case, and coolant/oil gauges.

To access Off-Road Pages, press the Vehicle button on the touchscreen, select the Offroad tab, and then select the OFF ROAD button on the main screen. Off-Road Pages can also be accessed through the app drawer.

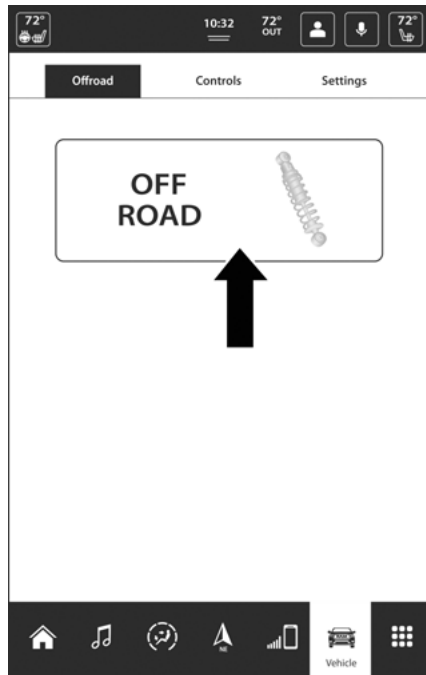

OFF ROAD Button

OFF-ROAD PAGES STATUS BAR

The Off-Road Pages Status Bar is located along the bottom of Off-Road Pages and is present in each of the selectable page options. It provides information for the following items:

1. Transfer Case Status
2. Latitude/Longitude
3. Altitude of the vehicle
4. Status of Hill Descent or Selec-Speed Control at Target Selected Speed in mph (km/h) — If Equipped

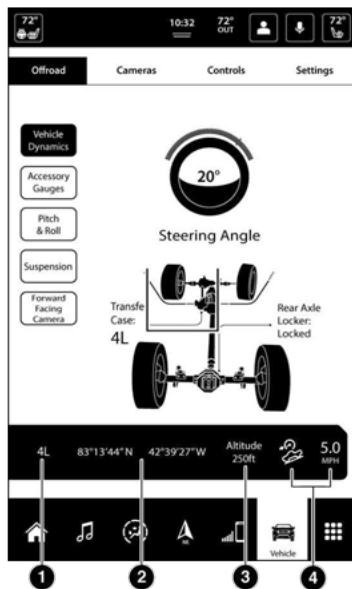

Status Bar 2WD/4WD

- 1 – Transfer Case Status
- 2 – Latitude/Longitude
- 3 – Altitude
- 4 – Hill Descent Or Selec-Speed Control Status

VEHICLE DYNAMICS

The Vehicle Dynamics page displays information concerning the vehicle's transfer case and steering angle.

The following information is displayed:

1. Steering angle in degrees
2. Status of Transfer Case
3. Status of the Rear Axle
4. Status of Front Axle – If Equipped

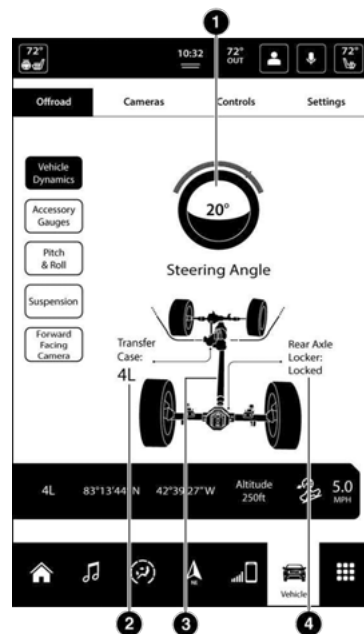

Drivetrain Menu 2WD/4WD

- 1 – Steering Angle
- 2 – Transfer Case Status
- 3 – Rear Axle
- 4 – Rear Axle Locker Status

ACCESSORY GAUGE

The Accessory Gauge page displays the current status of the vehicle's Coolant Temperature, Oil Temperature, Oil Pressure, Transmission Temperature, and Battery Voltage.

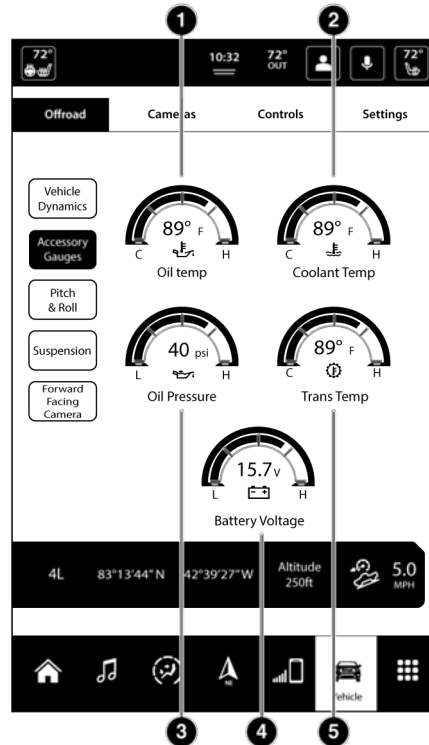

Accessory Gauge Menu 2WD/4WD

- 1 — Oil Temperature
- 2 — Coolant Temperature
- 3 — Oil Pressure
- 4 — Battery Voltage
- 5 — Transmission Temperature

PITCH & ROLL

The Pitch & Roll page displays the vehicle's current pitch (angle up and down) and roll (angle side to side) in degrees. The Pitch & Roll gauges provide a visualization of the current vehicle angle.

NOTE:

Pitch & Roll values may show upon startup. These numbers will update once the vehicle is driven.

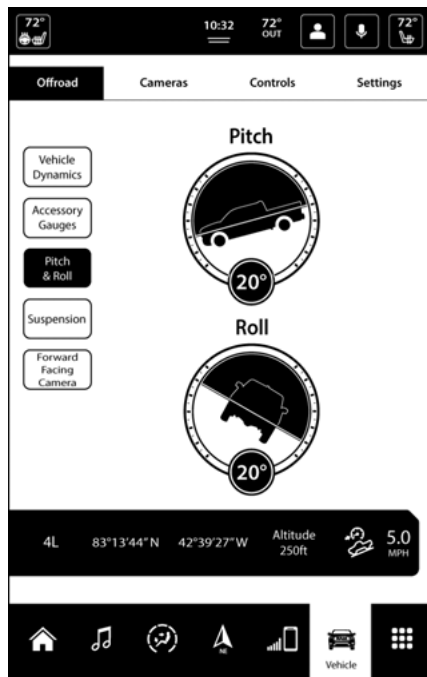

Pitch & Roll Menu 2WD/4WD

SUSPENSION — IF EQUIPPED

The Suspension page displays the current status of the vehicle's suspension system and the current ride height of the vehicle. The Suspension page will also indicate when the vehicle's height changes.

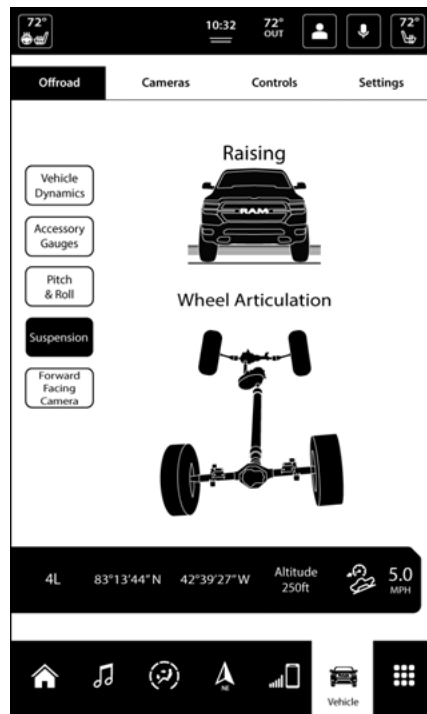

Suspension Menu

FORWARD FACING CAMERA— IF EQUIPPED

Your vehicle may be equipped with a Forward Facing Camera that allows you to see an on-screen image of the front view of your vehicle. The image will be displayed on the touchscreen along with a caution note “Check Entire Surroundings” across the top of the screen.

To activate, press the Forward Facing Camera button on the touchscreen.

TRAILER TOW — IF EQUIPPED

If your vehicle is equipped with Trailer Tow Pages, you will be able to view and edit different trailer settings for each of your unique trailers.

To access Trailer Tow Pages, press on the Vehicle icon in the lower menu bar on the touchscreen. From the Dashboard tab select “Towing & Trailers”.

TRAILER INFO

The Trailer Info main page displays your trailer's tire pressure, odometer, electronic range select, and view of your trailer's Tow/Haul mode status.

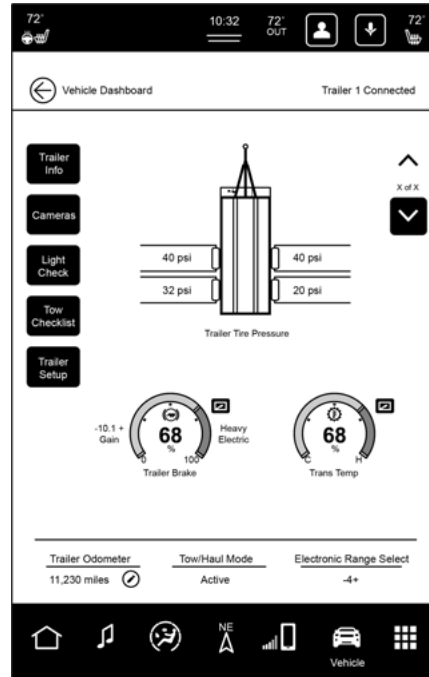

Trailer Tow Pages Info Tab

Displayed in the Trailer Info tab are the following gauges that show information for each separate trailer:

- Trailer Brake
- Transmission Temperature
- Coolant Temperature
- Oil Temperature
- Oil Pressure
- Battery Voltage

NOTE:

Press the Up and Down arrows on the right-hand side of your touchscreen to toggle between gauges, as only up to five will be displayed at a time.

The upper right-hand corner of each gauge will give you the option to maximize each gauge, which will show you the Gauge Detail View page that will show specific gauge information and a status graph of the gauge over time. To get back to the Trailer Info page, select the same icon located at the top right.

NOTE:

If any gauge reaches a critical condition, the fill bar, numerical readout, and icon will be displayed in bright red.

CAMERAS

Selecting the Camera tab within “Trailer Tow Pages” will redirect you to the Trailer tab in the More Cams section of the Camera app.

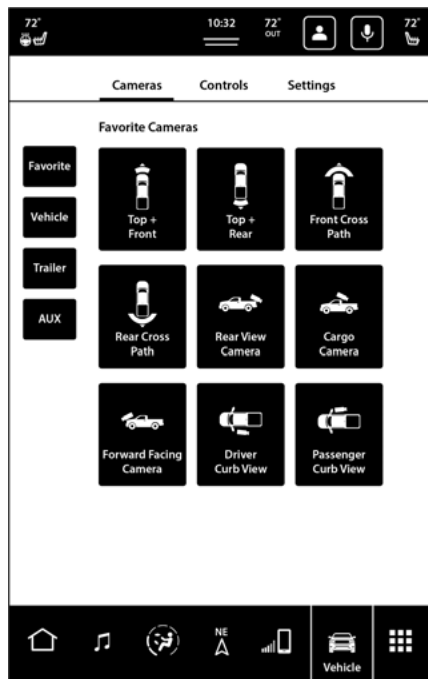

Trailer Tow Pages Camera Tab

After selecting your desired trailer camera view, selecting the More Cams button will take you back to the previous screen.

In order for the camera's features to be accessible, the Surround View Camera settings have to be enabled → page 227.

LIGHT CHECK

Pressing the Light Check tab will open the Light Check Ready page. A box will appear with the text "Activate Light Check", which will allow you to check your trailer's brake lights.

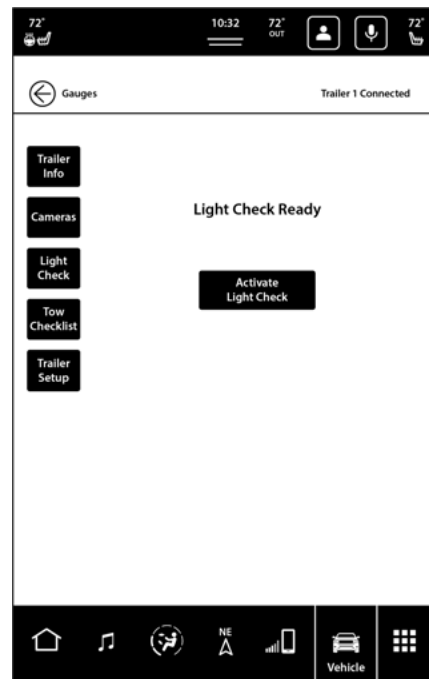

Trailer Tow Pages Light Check Tab

Once selected, the screen will change to "Light Check in Progress". The box will turn red and the text will read

“Cancel Light Check”, which will then turn the trailer’s brake lights back off.

Checking “Auto Trailer Light Check” in the “Trailer Brake/Trailer” Uconnect Settings will automatically turn on your trailer’s lights once the trailer is attached to the vehicle. For more information ⇨ page 227.

NOTE:

After two minutes, if “Cancel Light Check” is not selected, the screen will automatically revert back to the Activate Light Check screen.

SETUP

After selecting your trailer of choice, selecting the Setup tab will redirect to the Uconnect Settings “Trailer Brake/Trailer” feature, ⇨ page 227.

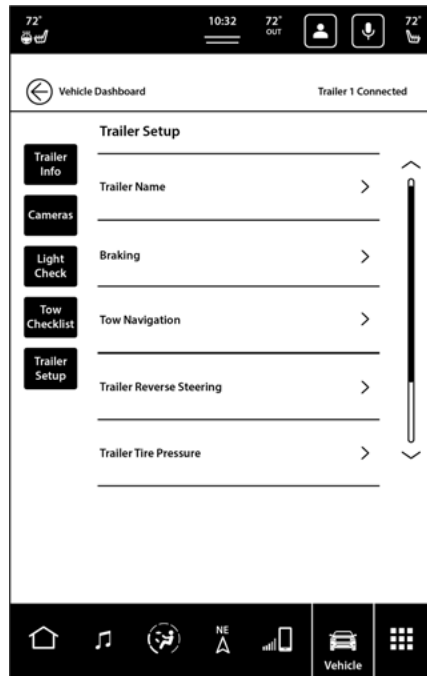

Trailer Tow Pages Setup Tab

NOTE:

Make sure that “Use this Trailer” is selected in order to make any settings changes to that selected trailer.

SAFETY

SAFETY FEATURES

ANTI-LOCK BRAKE SYSTEM (ABS)

The ABS provides increased vehicle stability and brake performance under most braking conditions. The system automatically prevents wheel lock and enhances vehicle control during braking.

The ABS performs a self-check cycle to ensure that the ABS is working properly each time the vehicle is started and driven. During this self-check, you may hear a slight clicking sound as well as some related motor noises.

The ABS is activated during braking when the system detects one or more wheels are beginning to lock. Road conditions such as ice, snow, gravel, bumps, railroad tracks, loose debris, or panic stops may increase the likelihood of ABS activation(s).

You also may experience the following normal characteristics when the ABS activates:

- ABS motor noise or clicking sounds (you may continue to hear for a short time after the stop)
- Brake pedal pulsations

The ABS is designed to function with the Original Equipment Manufacturer (OEM) tires. Modification may result in degraded ABS performance.

WARNING!

- The ABS contains sophisticated electronic equipment that may be susceptible to interference caused by improperly installed or high output radio transmitting equipment. This interference can cause possible loss of anti-lock braking capability. Installation of such equipment should be performed by qualified professionals.
- Pumping of the Anti-Lock Brakes will diminish their effectiveness and may lead to a collision. Pumping makes the stopping distance longer. Just press firmly on your brake pedal when you need to slow down or stop.
- The ABS cannot prevent the natural laws of physics from acting on the vehicle, nor can it increase braking or steering efficiency beyond that afforded by the condition of the vehicle brakes and tires or the traction afforded.
- The ABS cannot prevent collisions, including those resulting from excessive speed in turns, following another vehicle too closely, or hydroplaning.
- The capabilities of an ABS equipped vehicle must never be exploited in a reckless or dangerous manner that could jeopardize the user's safety or the safety of others.

Anti-Lock Brake System (ABS) Warning Light

The yellow ABS Warning Light will turn on when the power button is placed in the ON/RUN mode and may stay on for as long as four seconds.

If the ABS Warning Light remains on or comes on while driving, it indicates that the anti-lock portion of the brake system is not functioning and that service is required. However, the conventional brake system will continue to operate normally if the ABS Warning Light is on.

If the ABS Warning Light is on, the brake system should be serviced as soon as possible to restore the benefits of Anti-Lock Brakes. If the ABS Warning Light does not come on when the power button is placed in the ON/RUN mode, have the light repaired as soon as possible.

ELECTRONIC BRAKE CONTROL (EBC) SYSTEM

Your vehicle is equipped with an advanced Electronic Brake Control (EBC) system. This system includes Anti-Lock Brake System (ABS), Brake Assist System (BAS), Electronic Brake Force Distribution (EBD), Electronic Roll Mitigation (ERM), Electronic Stability Control (ESC), Hill Start Assist (HSA), and Traction Control System (TCS). These systems work together to enhance

both vehicle stability and control in various driving conditions.

Your vehicle may also be equipped with Trailer Sway Control (TSC) and Selec-Speed Control (SSC).

Brake Assist System (BAS)

The BAS is designed to optimize the vehicle's braking capability during emergency braking maneuvers. The system detects an emergency braking situation by sensing the rate and amount of brake application, and then applies optimum pressure to the brakes. This can help reduce braking distances. The BAS complements the Anti-Lock Brake System (ABS). Applying the brakes very quickly results in the best BAS assistance. To receive the benefit of the system, you must apply continuous braking pressure during the stopping sequence (do not "pump" the brakes). Do not reduce brake pedal pressure unless braking is no longer desired. Once the brake pedal is released, the BAS is deactivated.

WARNING!

The Brake Assist System (BAS) cannot prevent the natural laws of physics from acting on the vehicle, nor can it increase the traction afforded by prevailing road conditions. BAS cannot prevent collisions, including those resulting from excessive speed in turns, driving on very slippery surfaces, or hydroplaning. The capabilities of a BAS-equipped vehicle must never be exploited in a reckless or dangerous manner, which could jeopardize the user's safety or the safety of others.

Brake System Warning Light

The red Brake System Warning Light will turn on when the power button is placed in the ON/RUN mode and may stay on for as long as four seconds.

If the Brake System Warning Light remains on or comes on while driving, it indicates that the brake system is not functioning properly and that immediate service is required. If the Brake System Warning Light does not come on when the power button is placed in the ON/RUN mode, have the light repaired as soon as possible.

Electronic Brake Force Distribution (EBD)

EBD manages the distribution of the braking torque between the front and rear axles by limiting braking pressure to the rear axle. This is done to prevent overslip of the rear wheels to avoid vehicle instability, and to prevent the rear axle from entering the Anti-Lock Brake System (ABS) before the front axle.

Electronic Roll Mitigation (ERM)

The ERM system anticipates the potential for wheel lift by monitoring the driver's steering wheel input and the speed of the vehicle. When ERM determines that the rate of change of the steering wheel angle and vehicle's speed are sufficient to potentially cause wheel lift, it then applies the appropriate brake and may also reduce engine power to lessen the chance that wheel lift will occur. ERM can only reduce the chance of wheel lift occurring during severe or evasive driving maneuvers; it cannot prevent wheel lift due to other factors, such as road conditions, leaving the roadway, striking objects or other vehicles.

WARNING!

Many factors, such as vehicle loading, road conditions and driving conditions, influence the chance that wheel lift or rollover may occur. ERM cannot prevent all wheel lift or rollovers, especially those that involve leaving the roadway or striking objects or other vehicles. The capabilities of an ERM-equipped vehicle must never be exploited in a reckless or dangerous manner which could jeopardize the user's safety or the safety of others.

Electronic Stability Control (ESC)

ESC enhances directional control and stability of the vehicle under various driving conditions. ESC corrects for oversteering or understeering of the vehicle by applying the brake of the appropriate wheel(s) to counteract these conditions. Engine power may also be reduced to help the vehicle maintain the desired path.

- Oversteer – when the vehicle is turning more than appropriate for the steering wheel position.
- Understeer – when the vehicle is turning less than appropriate for the steering wheel position.

ESC uses sensors in the vehicle to determine the vehicle path intended by the driver and compares it to the actual path of the vehicle. When the actual path does not match the intended path, ESC applies the brake of the appropriate wheel to assist in counteracting the oversteer or understeer condition.

The ESC Activation/Malfunction Indicator Light located in the instrument cluster will start to flash as soon as the ESC system becomes active. The ESC Activation/Malfunction Indicator Light also flashes when the TCS is

active. If the ESC Activation/Malfunction Indicator Light begins to flash during acceleration, ease up on the accelerator and apply as little throttle as possible. Be sure to adapt your speed and driving to the prevailing road conditions.

WARNING!

- Electronic Stability Control (ESC) cannot prevent the natural laws of physics from acting on the vehicle, nor can it increase the traction afforded by prevailing road conditions. ESC cannot prevent accidents, including those resulting from excessive speed in turns, driving on very slippery surfaces, or hydroplaning. ESC also cannot prevent accidents resulting from loss of vehicle control due to inappropriate driver input for the conditions. Only a safe, attentive, and skillful driver can prevent accidents. The capabilities of an ESC equipped vehicle must never be exploited in a reckless or dangerous manner which could jeopardize the user's safety or the safety of others.
- Vehicle modifications, or failure to properly maintain your vehicle, may change the handling characteristics of your vehicle, and may negatively affect the performance of the ESC system. Changes to the steering system, suspension, braking system, tire type and size or wheel size may adversely affect ESC performance. Improperly inflated and unevenly worn tires may also degrade ESC performance. Any vehicle modification or poor vehicle maintenance that reduces the effectiveness of the ESC system can increase the risk of loss of vehicle control, vehicle rollover, personal injury and death.

ESC Operating Modes

Depending upon model and mode of operation, the ESC system may have multiple operating modes.

ESC On

This is the normal operating mode for the ESC. Whenever the vehicle is started, the ESC system will be in this mode. This mode should be used for most driving conditions. Alternate ESC modes should only be used for specific reasons as noted in the following paragraphs.

Partial Off

This mode may be useful if the vehicle becomes stuck. This mode may modify TCS and ESC thresholds for activation, which allows for more wheel spin than normally allowed.

To enter the "Partial Off" mode, momentarily push the ESC OFF button and the ESC OFF Indicator Light will illuminate. To turn the ESC on again, momentarily push the ESC OFF button and the ESC OFF Indicator Light will turn off.

NOTE:

For vehicles with multiple partial ESC modes, the push and release of the button will toggle the ESC modes. Multiple attempts may be required to return to "ESC On".

WARNING!

- When in "Partial Off" mode, the TCS functionality of ESC (except for the limited slip feature

(Continued)

WARNING!

described in the TCS section) has been disabled and the ESC OFF Indicator Light will be illuminated. When in "Partial Off" mode, the engine power reduction feature of TCS is disabled, and the enhanced vehicle stability offered by the ESC system is reduced.

- Trailer Sway Control (TSC) is disabled when the ESC system is in the "Partial Off" mode.

Full Off — If Equipped

This mode is intended for off-highway or off-road use only and should not be used on any public roadways. In this mode, TCS and ESC features are turned off. To enter the "Full Off" mode, push and hold the ESC OFF button for five seconds while the vehicle is stopped with the engine running. After five seconds, a chime will sound, the ESC OFF Indicator Light will illuminate, and the "ESC OFF" message will display in the instrument cluster. To turn ESC on again, momentarily push the ESC OFF button.

NOTE:

System may switch from ESC "Full Off" to "Partial Off" mode when vehicle exceeds a predetermined speed. When the vehicle speed slows below the predetermined speed the system will return to ESC "Full Off".

WARNING!

- In the ESC "Full Off" mode, the engine torque reduction and stability features are disabled. Therefore, enhanced vehicle stability offered by

(Continued)

WARNING!

the ESC system is unavailable. In an emergency evasive maneuver, the ESC system will not engage to assist in maintaining stability. ESC "Full Off" mode is intended for off-highway or off-road use only.

- The Electronic Stability Control (ESC) cannot prevent the natural laws of physics from acting on the vehicle, nor can it increase the traction afforded by prevailing road conditions. ESC cannot prevent all accidents, including those resulting from excessive speed in turns, driving on very slippery surfaces, or hydroplaning. ESC also cannot prevent collisions.

ESC Activation/Malfunction Indicator Light And ESC OFF Indicator Light



The ESC Activation/Malfunction Indicator Light in the instrument cluster will come on when the power button is placed in the ON/RUN mode. If the ESC Activation/

Malfunction Indicator Light comes on continuously with the power button on, a malfunction has been detected in the ESC system. If this light remains on after several key cycles, and the vehicle has been driven several miles (kilometers) at speeds greater than 30 mph (48 km/h), see an authorized dealer as soon as possible to have the problem diagnosed and corrected.

The ESC Activation/Malfunction Indicator Light starts to flash as soon as the tires lose traction and the ESC system becomes active. The ESC Activation/Malfunction Indicator Light also flashes when TCS is active. If the ESC Activation/Malfunction Indicator Light

begins to flash during acceleration, ease up on the accelerator and apply as little throttle as possible. Be sure to adapt your speed and driving to the prevailing road conditions.



The ESC OFF Indicator Light indicates that the Electronic Stability Control (ESC) is in a reduced mode.

NOTE:

- The ESC Activation/Malfunction Indicator Light and the ESC OFF Indicator Light come on momentarily each time the power button is placed in the ON/RUN mode.
- Each time the power button is placed in the ON/RUN mode, the ESC system will be on even if it was turned off previously.
- The ESC system will make buzzing or clicking sounds when it is active. This is normal; the sounds will stop when ESC becomes inactive following the maneuver that caused the ESC activation.

Hill Start Assist (HSA)

HSA is designed to mitigate roll back from a complete stop while on an incline. If the driver releases the brake while stopped on an incline, HSA will continue to hold the brake pressure for a short period. If the driver does not apply the throttle before this time expires, the system will release brake pressure and the vehicle will roll down the hill as normal.

The following conditions must be met in order for HSA to activate:

- The feature must be enabled.
- The vehicle must be stopped.

- The parking brake must be off.
- The driver door must be closed.
- The vehicle must be on a sufficient grade.
- The gear selection must match vehicle uphill direction (i.e., vehicle facing uphill is in forward gear; vehicle backing uphill is in REVERSE gear).
- HSA will work in REVERSE gear and all forward gears. The system will not activate if the vehicle is in PARK or NEUTRAL.

WARNING!

There may be situations where the Hill Start Assist (HSA) will not activate and slight rolling may occur, such as on minor hills or with a loaded vehicle, or while pulling a trailer. HSA is not a substitute for active driving involvement. It is always the driver's responsibility to be attentive to distance to other vehicles, people, and objects, and most importantly brake operation to ensure safe operation of the vehicle under all road conditions. Your complete attention is always required while driving to maintain safe control of your vehicle. Failure to follow these warnings can result in a collision or serious personal injury.

Disabling And Enabling HSA

This feature can be turned on or turned off. To change the current setting, proceed as follows:

If disabling HSA using Uconnect Settings  page 227.

Towing With HSA

HSA will also provide assistance to mitigate roll back while towing a trailer.

WARNING!

- If you use a trailer brake controller with your trailer, the trailer brakes may be activated and deactivated with the brake switch. If so, there may not be enough brake pressure to hold both the vehicle and the trailer on a hill when the brake pedal is released. In order to avoid rolling down an incline while resuming acceleration, manually activate the trailer brake or apply more vehicle brake pressure prior to releasing the brake pedal.
- HSA is not a parking brake. Always apply the parking brake fully when exiting your vehicle. Also, be certain to place the vehicle in PARK.
- Failure to follow these warnings can result in a collision or serious personal injury.

Rain Brake Support (RBS)

RBS may improve braking performance in wet conditions. It will periodically apply a small amount of brake pressure to remove any water buildup on the front brake rotors. It functions when the windshield wipers are in LO or HI speed. When Rain Brake Support is active, there is no notification to the driver and no driver interaction is required.

Ready Alert Braking (RAB)

RAB may reduce the time required to reach full braking during emergency braking situations. It anticipates

when an emergency braking situation may occur by monitoring how fast the throttle is released by the driver. The Electronic Brake Control system will prepare the brake system for a panic stop.

Selec-Speed Control (SSC) – If Equipped

SSC is intended for off-road driving in 4WD Low only. SSC maintains vehicle speed by actively controlling engine torque and brakes.

SSC has three states:

1. Off (feature is not enabled and will not activate)
2. Enabled (feature is enabled and ready but activation conditions are not met, or driver is actively overriding with brake or accelerator pedal application)
3. Active (feature is enabled and actively controlling vehicle speed)

Enabling SSC

SSC is enabled by pushing the SSC switch, but the following conditions must also be met to enable SSC:

- The driveline is in 4WD Low.
- The vehicle speed is below 5 mph (8 km/h).
- The parking brake is released.
- The driver door is closed.
- The driver is not applying the accelerator.

Activating SSC

Once SSC is enabled it will activate automatically once the following conditions are met:

- The driver releases the accelerator pedal.
- The driver releases the brake pedal.
- The vehicle is in any selection other than PARK.
- Your vehicle speed is below 20 mph (32 km/h).

The set speed for SSC is selectable by the driver, and can be adjusted by using the gear shift +/- . Additionally, the SSC set speed may be reduced when climbing a grade and the level of set speed reduction depends on the magnitude of grade. The following summarizes the SSC set speeds:

SSC Target Set Speeds

- 1st = 0.6 mph (1 km/h)
- 2nd = 1.2 mph (2 km/h)
- 3rd = 1.8 mph (3 km/h)
- 4th = 2.5 mph (4 km/h)
- 5th = 3.1 mph (5 km/h)
- 6th = 3.7 mph (6 km/h)
- 7th = 4.3 mph (7 km/h)
- 8th = 5 mph (8 km/h)
- 9th = 5.6 mph (9 km/h) – if equipped
- REVERSE = 0.6 mph (1 km/h)
- NEUTRAL = 1.2 mph (2 km/h)
- PARK = SSC remains enabled but not active

NOTE:

- During SSC, the +/- gear selector input is used for SSC target speed selection but will not affect the gear chosen. While actively controlling SSC, the vehicle will shift appropriately for the driver-selected set speed and corresponding driving conditions.
- SSC operation is influenced by Off Road+ drive mode if active. The differences may be notable to the driver as a varying level of aggressiveness.

Driver Override

The driver may override SSC activation with accelerator or brake pedal application at any time.

Deactivating SSC

SSC will be deactivated but remain available if any of the following conditions occur:

- The driver overrides SSC set speed with accelerator or brake pedal application.
- The vehicle speed exceeds 20 mph (32 km/h) but remains below 40 mph (64 km/h).
- The vehicle is shifted into PARK.

Disabling SSC

SSC will deactivate and be disabled if any of the following conditions occur:

- The driver pushes the SSC switch.
- The driveline is shifted out of the 4WD Low.
- The parking brake is applied.
- The driver door opens.

- The vehicle is driven greater than 20 mph (32 km/h) for greater than 70 seconds.
- The vehicle is driven greater than 40 mph (64 km/h). SSC will exist immediately.

Feedback To The Driver

The instrument cluster has an SSC icon and the SSC switch has a lamp which offers feedback to the driver about the state SSC is in.

- The cluster icon and switch lamp will illuminate and remain on solid when SSC is enabled or activated. These are the normal operating conditions for SSC.
- The cluster icon and switch lamp will flash for several seconds then extinguish when the driver pushes the SSC switch but enabled conditions are not met.
- The cluster icon and switch lamp will flash for several seconds then extinguish when SSC disables due to excess speed.
- The cluster icon and switch lamp will flash then extinguish when SSC deactivates due to overheated brakes.

WARNING!

SSC is only intended to assist the driver in controlling vehicle speed when driving in off road conditions. The driver must remain attentive to the driving conditions and is responsible for maintaining a safe vehicle speed.

Traction Control System (TCS)

The TCS monitors the amount of wheel spin of each of the driven wheels. If wheel spin is detected, the TCS may apply brake pressure to the spinning wheel(s) and/or reduce power to provide enhanced acceleration and stability. A feature of the TCS, Brake Limited Differential (BLD) functions similarly to a limited slip differential and controls the wheel spin across a driven axle. If one wheel on a driven axle is spinning faster than the other, the system will apply the brake of the spinning wheel. This will allow more power to be applied to the wheel that is not spinning. BLD may remain enabled even if TCS and Electronic Stability Control (ESC) are in reduced modes.

Trailer Sway Control (TSC)

TSC uses sensors in the vehicle to recognize an excessively swaying trailer and will take the appropriate actions to attempt to stop the sway.

NOTE:

TSC cannot stop all trailers from swaying. Always use caution when towing a trailer and follow the trailer tongue weight recommendations → page 206.

When TSC is functioning, the ESC Activation/ Malfunction Indicator Light will flash, the acceleration may be reduced and you may feel the brakes being applied to individual wheels to attempt to stop the trailer from swaying. TSC is disabled when the ESC system is in the "Partial Off" or "Full Off" modes.

WARNING!

If TSC activates while driving, slow the vehicle down, stop at the nearest safe location, and adjust the trailer load to eliminate trailer sway.

DROWSY DRIVER DETECTION (DDD) — IF EQUIPPED

DDD detects when the driver is feeling fatigued and warns the driver to pull over and take a break.

To Activate/Deactivate

DDD can be activated and deactivated through the Uconnect system by selecting the following in order:

1. “Safety & Driving Assistance”
2. “Drowsy Driver Detection”

WARNING!

The DDD system is an aid for driving and does not relieve the driver of the responsibility of driving the vehicle. Always drive alert and get plenty of rest before driving. If you experience fatigue while driving, do not wait for the DDD to intervene with a warning. Choose a safe and secure location where you can pull over safely for a break. Only return to the road when you are in the right physical and mental condition to prevent endangering yourself and others.

System Operation

Using feedback obtained from the driver’s steering patterns, any buttons/switches that are pressed, and

from the front camera, the system implements two operating logics:

- The first operating logic takes the driving style into account, observing the road and detecting to what extent the driver can continue driving with few lane crossing events.
- The second operating logic measures the time spent behind the wheel with the vehicle speed above 40 mph (60 km/h) and below 100 mph (160 km/h).

If the driving style indicates that the driver is unable to follow the road trajectory and respect the horizontal lane markings while within the operating speed range of the system, a pop up will display on the instrument cluster display to suggest that the driver should stop for a break. An audible signal will also sound.

If the driver **accepts** the suggestion provided by the system by pushing the “OK” button on the left side of the steering wheel, the message will disappear from the display.

If the driver **does not acknowledge**, the warning message will remain active in the instrument cluster display.

NOTE:

In the event of a DDD system failure, a dedicated message will appear in the instrument cluster display.



DDD Warning Message

AUDIBLE PEDESTRIAN WARNING SYSTEM - IF EQUIPPED

Your vehicle is equipped with an Audible Pedestrian Warning system. The Audible Pedestrian Warning system uses distinct sounds to alert pedestrians that your vehicle is approaching. In addition, the system will indicate changes in vehicle speed by varying the relative volume.

The system uses two external speakers. One is located in the under-hood compartment and the other is in the rear of the vehicle. The Audible Pedestrian Warning system is active when the vehicle is not in PARK and is traveling at lower speeds. Depending on the selected gear (REVERSE, DRIVE, or NEUTRAL), the system activates the corresponding speaker location based on the intended direction of travel.

NOTE:

The system is active when driving in Electric mode only.

WARNING!

The Audible Pedestrian Warning system is not intended to avoid a collision. It is always the driver's responsibility to be attentive to the vehicle's distance between other vehicles, people, and objects, and most importantly utilize brake operation to ensure safe driving of the vehicle under all road conditions. Your complete attention is always required while driving to maintain safe control of your vehicle. Failure to follow this warning could result in a collision or serious personal injury.

REAR SEAT REMINDER ALERT (RSRA)

RSRA alerts of the possible presence of an object, passenger, or pet in the rear seats through a visual and auditory notification. When the system is activated, it displays the message "Check Rear Seat" on the instrument cluster display and sounds an auditory alert upon the driver placing the power button in the OFF position to exit the vehicle. The system will activate automatically if a rear door is opened within 10 minutes of the power button being placed in the ON/RUN position. RSRA should be used as a reminder to check the rear seats: it does not directly detect objects, passengers, or pets and is only activated when the previous conditions are met.

To enable or disable RSRA, see ➞ page 227.

WARNING!

- Before exiting a vehicle, always come to a complete stop, then shift the vehicle into PARK and apply the parking brake.
- Always make sure the power button is in the OFF position, key fob is removed from the vehicle and vehicle is locked.
- Never leave children alone in a vehicle, or with access to an unlocked vehicle. Leaving children in a vehicle unattended is dangerous for a number of reasons. A child or others could be seriously or fatally injured. Children should be warned not to touch the parking brake, brake pedal or the gear selector.
- Do not leave children or animals inside parked vehicles in hot weather. Interior heat buildup may cause serious injury or death.

AUXILIARY DRIVING SYSTEMS**BLIND SPOT MONITORING (BSM)**

BSM system uses two radar sensors, located inside the rear fascia/bumper, to detect highway licensable vehicles (automobiles, trucks, motorcycles, etc.) that enter the blind spot zones from the rear/front/side of the vehicle.

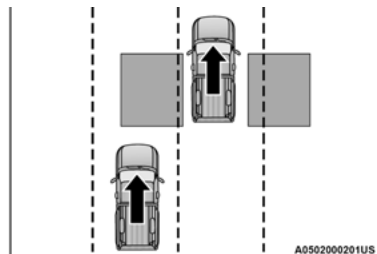
**Rear Detection Zones**

When the vehicle is started, the BSM Warning Light will momentarily illuminate in both outside rearview mirrors to let the driver know that the system is operational. The BSM system sensors operate when the vehicle is in any forward gear.

The BSM detection zone covers approximately one lane in width on both sides of the vehicle 12 ft (3.8 m). The zone length starts at the side of the vehicle, near the B-pillar, and extends approximately 10 ft (3 m) beyond the rear fascia/bumper of the vehicle. The BSM system monitors the detection zones on both sides of the vehicle when the vehicle speed is 7 mph (11 km/h) or higher and will alert the driver of vehicles in these areas. BSM will alert earlier on faster-approaching vehicles – up to 33 mph (54 km/h) difference.

NOTE:

- The BSM system DOES NOT alert the driver about rapidly approaching vehicles that are outside the detection zones.
- BSM may experience dropouts (blinking on and off) of the side mirror warning indicator lights when a

motorcycle or any small object remains at the side of the vehicle for extended periods of time (more than a couple of seconds).

The BSM system can become blocked if snow, ice, mud, or other road contaminants accumulate on the rear fascia/bumper where the radar sensors are located. The system may also detect blockage if the vehicle is operated in areas with extremely low radar returns such as a desert or parallel to a large elevation drop. If blockage is detected, a “Blind Spot Temporarily Unavailable, Sensor Blocked” message will display in the cluster, both mirror lights will illuminate, and BSM and RCP alerts will not occur. This is normal operation. The system will automatically recover and resume function when the condition clears or when a key cycle occurs. To minimize system blockage, do not block the area of the rear fascia/bumper where the radar sensors are located with foreign objects (bumper stickers, bicycle racks, etc.) and keep it clear of road contaminants.

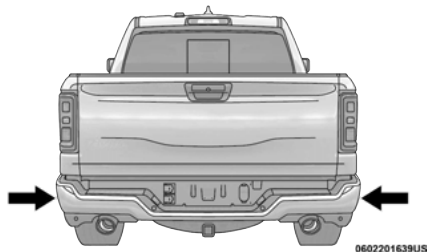

Radar Sensor Locations

The BSM system notifies the driver of objects in the detection zones by illuminating the BSM Warning Light located in the outside mirrors. In addition, when the turn signal is activated during the alert on the side of the vehicle corresponding to the alert, an audible (chime) alert can be heard. During this audible (chime) alert, the radio volume will be reduced → page 292.

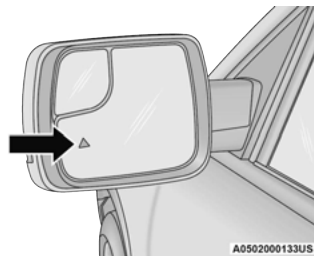

Warning Light Location

The BSM system monitors the detection zone from three different entry points (Side, Rear, Front) while driving to see if an alert is necessary. The BSM system will issue an alert during these types of zone entries.

Entering From The Side

Vehicles that move into your adjacent lanes from either side of the vehicle.

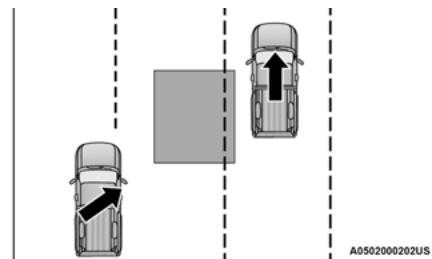

Side Monitoring

Entering From The Rear

Vehicles that come up from behind your vehicle on either side and enter the rear detection zone with a relative speed of less than 33 mph (54 km/h). Fast approaching vehicles will receive an earlier alert based on relative speed.

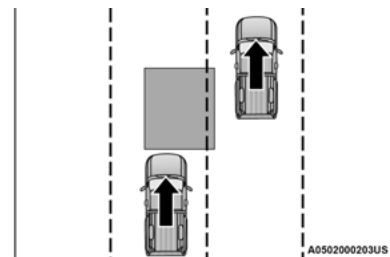

Rear Monitoring

Overtaking Traffic

If you pass another vehicle slowly with a relative speed of less than 13 mph (24 km/h) the warning light will be illuminated. If the difference in speed between the two vehicles is greater than 13 mph (24 km/h), the warning light will not illuminate.

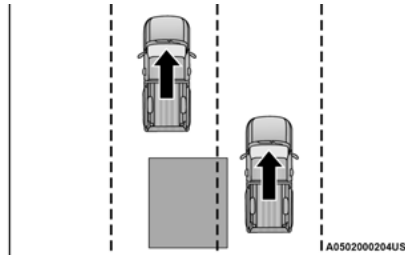

Overtaking/Approaching

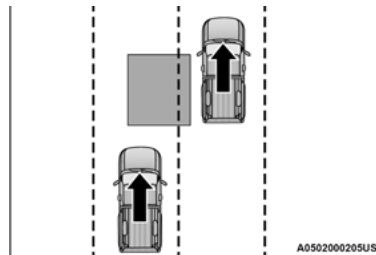

Overtaking/Passing

The BSM system is designed not to issue an alert on stationary objects such as guardrails, posts, walls,

foliage, berms, etc. However, occasionally the system may alert on such objects. This is normal operation and your vehicle does not require service.

The BSM system will not alert you of objects that are traveling in the opposite direction of the vehicle in adjacent lanes.

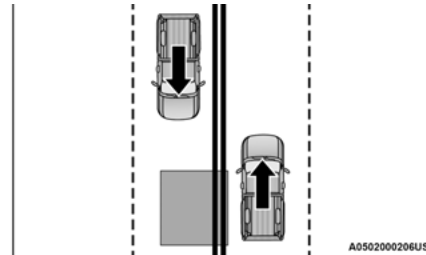

Opposing Traffic

WARNING!
<p>The Blind Spot Monitoring system is only an aid to help detect objects in the blind spot zones. The BSM system is not designed to detect pedestrians, bicyclists, or animals. Even if your vehicle is equipped with the BSM system, always check your vehicle's mirrors, glance over your shoulder, and use your turn signal before changing lanes. Failure to do so can result in serious injury or death.</p>

Rear Cross Path (RCP)

RCP is intended to aid the driver when backing out of parking spaces where their vision of oncoming vehicles

may be blocked. Proceed slowly and cautiously out of the parking space until the rear end of the vehicle is exposed. The RCP system will then have a clear view of the cross traffic and if an oncoming vehicle is detected, alert the driver.

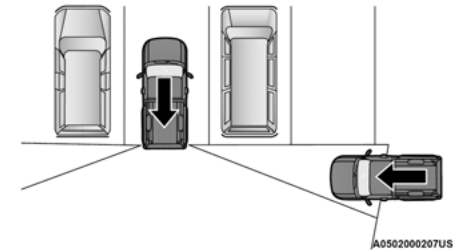

RCP Detection Zones

RCP monitors the rear detection zones on both sides of the vehicle, for objects that are moving toward the side of the vehicle with a minimum speed of approximately 5 mph (8 km/h), to objects moving a maximum of approximately 20 mph (32 km/h), such as in parking lot situations.

NOTE:

In a parking lot situation, oncoming vehicles can be obscured by vehicles parked on either side. If the sensors are blocked by other structures or vehicles, the system will not be able to alert the driver.

When RCP is on and the vehicle is in REVERSE, the driver is alerted using both the visual and audible alarms, including reducing the radio volume.

WARNING!

Rear Cross Path Detection (RCP) is not a backup aid system. It is intended to be used to help a driver detect an oncoming vehicle in a parking lot situation. Drivers must be careful when backing up, even when using RCP. Always check carefully behind your vehicle, look behind you, and be sure to check for pedestrians, animals, other vehicles, obstructions, and blind spots before backing up. Failure to do so can result in serious injury or death.

Blind Spot Modes

Blind Spot has three selectable modes of operation that are available in the Uconnect system.

Blind Spot Alert Lights Only

When operating in Blind Spot Alert mode, the BSM system will provide a visual alert in the appropriate side view mirror based on a detected object. However, when the system is operating in Rear Cross Path (RCP) mode, the system will respond with both visual and audible alerts when a detected object is present. Whenever an audible alert is requested, the radio is muted.

Blind Spot Alert Lights/Chime

When operating in Blind Spot Alert Lights/Chime mode, the BSM system will provide a visual alert in the appropriate side view mirror based on a detected object. If the turn signal is then activated, and it corresponds to an alert present on that side of the vehicle, an audible chime will also be sounded. Whenever a turn signal and detected object are present on the same side at the same time, both the visual and

audible alerts will be issued. In addition to the audible alert the radio (if on) will also be muted.

NOTE:

Whenever an audible alert is requested by the BSM system, the radio is also muted.

When the system is in RCP, the system shall respond with both visual and audible alerts when a detected object is present. Whenever an audible alert is requested, the radio is also muted. Turn/hazard signal status is ignored; the RCP state always requests the chime.

Blind Spot Alert Off

When the BSM system is turned off there will be no visual or audible alerts from either the BSM, RCP, or Trailer Merge Assist systems.

NOTE:

The BSM system will store the current operating mode when the vehicle is shut off. Each time the vehicle is started the previously stored mode will be recalled and used.

Turn Signal Activated Blind Spot Assist — If Equipped

When enabled in the Uconnect system and a turn signal is activated, the corresponding side view mirror camera will display in the radio. The camera will continue to display as long as the turn signal is engaged. If “Only With Trailer” is selected (if equipped), the camera will only display when a trailer is connected to the vehicle
 page 227.

WARNING!

Blind Spot Assist is only an aid to help detect objects in the blind spot zones and may not provide alerts when changing lanes under all driving conditions. Even if your vehicle is equipped with the BSA system, always check your vehicle's mirrors, glance over your shoulder, and use turn signals before changing lanes. Failure to do so can result in serious injury or death.

Trailer Merge Assist — If Equipped

Trailer Merge Assist is a function of the Blind Spot Monitoring (BSM) system that extends the blind spot zone to work while pulling a trailer.

NOTE:

When Trailer Merge Assist is activated, Rear Cross Path is disabled.

Trailer Merge Assist consists of three sub functions:

- Automatic Trailer Detection
- Trailer Length Detection
- Trailer Merge Warning

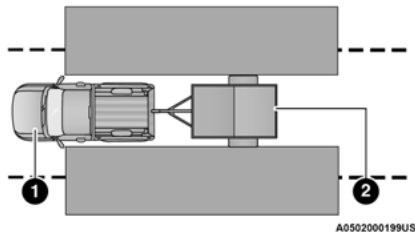



Blind Spot Zones With Trailer Merge Assist

- 1 — Vehicle
2 — Trailer

Automatic Trailer Detection

There are two modes of operation for the detection of the trailer length:

- 
Automatic Mode — When “Auto Mode” is selected, the system will use the blind spot radar sensors to automatically determine the presence and length of a trailer. The presence of a trailer will be detected using the blind spot radar within 90 seconds of forward movement of the vehicle. The vehicle must be moving above 6 mph (10 km/h) to activate the feature. Once the trailer has been detected, the system will default to the maximum blind spot zone until the length has been verified. You will see “Auto” in the instrument panel cluster.
- 
Maximum Mode — When “Max Mode” is selected, the system will default to the maximum blind spot zone regardless of what size trailer is attached.

NOTE:

Selected setting is stored when the power button is placed in the OFF position. To change this setting, it must be selected through the Uconnect Settings  page 227.

Trailer Length Detection

Once the trailer presence has been established, the trailer length will be established (by making a 90 degree turn) and then the trailer length category (example 10-20 ft (3 m to 6 m)) will be displayed. This can take up to 30 seconds after completing the turn.

NOTE:

During the same key cycle, if the vehicle is at a standstill for a minimum of 90 seconds, a new “trailer detection request” is enabled by the system once the vehicle resumes motion.

The maximum trailer length supported by the Trailer Merge Assist feature is 39.5 ft (12 m). Trailer length is considered the forward most portion of the trailer hitch to the rearward most portion of the body, fascia/bumper, or ramp of the trailer.

The maximum width supported by the Trailer Merge Assist feature is 8.5 ft (2.59 m). Trailer width is measured at the widest portion of the trailer and may include wheels, tires, fenders, or rails.

NOTE:

Fifth wheel or gooseneck trailers are not supported by Trailer Merge Assist.

NOTE:

The ability to detect a trailer may be degraded in crowded or busy environments. Busy parking lots, narrow areas surrounded with trees, or any other

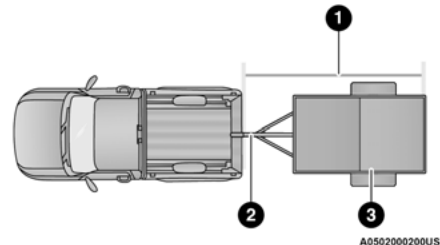

crowded area may prevent the radar sensors from being able to adequately detect the trailer. The system will try to detect a trailer at every key cycle or 90 seconds of standstill.





Trailer Length Detection

- 1 — Trailer Length
2 — Trailer Hitch
3 — Trailer Width

Trailer length will be identified and placed into one of the following categories:

- 
 Trailer length up to 10 ft (3 m) — Blind spot zone will be adjusted to 10 ft (3 m).
- 
 Trailer length between 10 ft to 20 ft (3 m to 6 m) — Blind spot zone will be adjusted to 20 ft (6 m).
- 
 Trailer length between 20 ft to 30 ft (6 m to 9 m) — Blind spot zone will be adjusted to 30 ft (9 m).

-  Trailer length between 20 ft to 30 ft (6 m to 9 m) — Blind spot zone will be adjusted to 30 ft (9 m).
-  Trailer length between 30 ft and 39.5 ft (9 m to 12 m) — Blind spot zone will be adjusted to Max distance.

NOTE:

Trailer length is determined within +/- 3 ft (1 m) of actual length. Trailers that are the same size as the category limit, 10/20/30 ft (3/6/9 m), could be subject to being placed in the category above or below the correct one.

Trailer Merge Warning

Trailer Merge Warning is the extension of the blind spot function to cover the length of the trailer, plus a safety margin, to warn the driver when there is a vehicle in the adjacent lane. The driver is alerted by the illumination of the BSM Warning Light located in the outside mirror on the side the other vehicle is detected on. In addition, an audible (chime) alert will be heard and radio volume will be reduced.

NOTE:

- The Trailer Merge Alert system DOES NOT alert the driver about rapidly approaching vehicles that are outside the detection zones.
- The Blind Spot Monitoring (BSM) system may experience drop outs (blinking on and off) of the side mirror warning indicator lights when a motorcycle or any small object remains at the side of the vehicle for extended periods of time (more than a couple of seconds).

- Crowded areas such as parking lots, neighborhoods, etc. may lead to an increased amount of false alerts. This is normal operation.

WARNING!

The Blind Spot Monitoring system is only an aid to help detect objects in the blind spot zones. The BSM system is not designed to detect pedestrians, bicyclists, or animals. Even if your vehicle is equipped with the BSM system, always check your vehicle's mirrors, glance over your shoulder, and use your turn signal before changing lanes. Failure to do so can result in serious injury or death.

**FORWARD COLLISION WARNING (FCW)
WITH MITIGATION — IF EQUIPPED**

FCW with Mitigation provides the driver with audible warnings, visual warnings (within the instrument cluster display), and may apply a brake jerk to warn the driver when it detects a potential frontal collision. The warnings and limited braking are intended to provide the driver with enough time to react, avoid or mitigate the potential collision.

NOTE:

FCW monitors the information from the forward looking sensors as well as the Electronic Brake Controller (EBC), to calculate the probability of a forward collision. When the system determines that a forward collision is probable, the driver will be provided with audible and visual warnings as well as a possible brake jerk warning.

If the driver does not take action based upon these progressive warnings, then the system will provide a limited level of active braking to help slow the vehicle and mitigate the potential forward collision. If the driver reacts to the warnings by braking and the system determines that the driver intends to avoid the collision by braking but has not applied sufficient brake force, the system will compensate and provide additional brake force as required.

If a FCW with Mitigation event begins at a speed below 32 mph (52 km/h), the system may provide the maximum braking possible to mitigate the potential forward collision. If the Forward Collision Warning with Mitigation event stops the vehicle completely, the system will hold the vehicle at standstill for two seconds and then release the brakes.

**FCW Message**

When the system determines a collision with the vehicle in front of you is no longer probable, the warning message will be deactivated → page 422.

NOTE:

- The minimum speed for FCW activation is 3 mph (5 km/h).
- The FCW alerts may be triggered on objects other than vehicles such as guardrails or sign posts based on the course prediction. This is expected and is a part of normal FCW activation and functionality.
- It is unsafe to test the FCW system. To prevent such misuse of the system, after four Active Braking events within a key cycle, the Active Braking portion of FCW will be deactivated until the next key cycle.
- The FCW system is intended for on-road use only. If the vehicle is taken off-road, the FCW system should be deactivated to prevent unnecessary warnings to the surroundings.
- FCW may not react to irrelevant objects such as overhead objects, ground reflections, objects not in the path of the vehicle, stationary objects that are far away, oncoming traffic, or leading vehicles with the same or higher rate of speed.
- FCW will be disabled like ACC, with the unavailable screens.

WARNING!

Forward Collision Warning (FCW) is not intended to avoid a collision on its own, nor can FCW detect every type of potential collision. The driver has the responsibility to avoid a collision by controlling the vehicle via braking and steering. Failure to follow this warning could lead to serious injury or death.

Turning FCW On Or Off

The FCW button is located in the Uconnect display in the control settings → page 227.

- To turn the FCW system on, press the forward collision button once.
- To turn the FCW system off, press the forward collision button once.

NOTE:

- When the FCW is "on", this allows the system to warn the driver of a possible collision with the vehicle in front.
- When the FCW is "off", this prevents the system from warning the driver of a possible collision with the vehicle in front. If the FCW is set to "off", "FCW OFF" will be displayed in the instrument cluster display.
- When FCW status is set to "Only Warning", this prevents the system from providing limited active braking, or additional brake support if the driver is not braking adequately in the event of a potential frontal collision.
- When FCW status is set to "Warning and Braking", this allows the system to warn the driver of a possible collision with the vehicle in front using audible/visual warnings and it applies autonomous braking.
- The FCW system state is kept in memory from one key cycle to the next. If the system is turned off, it will remain off when the vehicle is restarted.

FCW Braking Status And Sensitivity

The FCW Sensitivity and Active Braking status are programmable through the Uconnect system → page 227.

- Far
 - When the sensitivity of FCW is set to the "Far" setting and the system status is "Only Warning" or "Warning & Braking", this allows the system to warn the driver of a possible more distant collision with the vehicle in front using audible/visual warnings.
 - More cautious drivers that do not mind frequent warnings may prefer this setting.

NOTE:

The "Far" setting may result in a greater number of FCW possible collision warnings experienced.

- Medium
 - When the sensitivity of FCW is set to the "Medium" setting and the system status is "Only Warning" or "Warning & Braking", this allows the system to warn the driver of a possible collision with the vehicle in front using audible/visual warnings.
- Near
 - When the sensitivity of FCW is set to the "Near" setting and the system status is "Only Warning" or "Warning & Braking", this allows the system to warn the driver of a possible closer collision with the vehicle in front using audible/visual warnings.

- This setting provides less reaction time than the “Far” and “Medium” settings, which allows for a more dynamic driving experience.
- More dynamic or aggressive drivers that want to avoid frequent warnings may prefer this setting.

NOTE:

The “Near” setting may result in a lesser number of FCW possible collision warnings experienced.

FCW Limited Warning

If the instrument cluster displays “ACC/FCW Limited Functionality” or “ACC/FCW Limited Functionality Clean Front Windshield” momentarily, there may be a condition that limits FCW functionality. Although the vehicle is still driveable under normal conditions, the active braking may not be fully available. Once the condition that limited the system performance is no longer present, the system will return to its full performance state. If the problem persists, see an authorized dealer.

Service FCW Warning

If the system turns off, and the instrument cluster displays:

- ACC/FCW Unavailable Service Required
- Cruise/FCW Unavailable Service Required

This indicates there is an internal system fault. Although the vehicle is still drivable under normal conditions, have the system checked by an authorized dealer.

Evasive Steering Assist (ESA) — If Equipped

Evasive Steering Assist is a sub feature of the Automatic Emergency Braking (AEB) system. The ESA system aids the driver when a potential frontal collision is detected by the Forward Collision Warning (FCW) system and when the driver responds with an evasive action to avert the collision. The system will calculate the optimum vehicle trajectory to avoid the object while maintaining vehicle control. It can then assist the driver to make the evasive maneuver if all conditions are met.

ESA Preconditions:

- ESA is active when FCW (Only Warning or Warning and Braking) is on in the Uconnect Settings.
- ESA is active at speeds above 34 mph (55 kph) and below speeds of 83 mph (135 kph).
- ESA utilizes Blind Spot Monitoring, radar, and cameras to determine if a path is open. If no clear path is detected, ESA will not activate.

NOTE:

ESA will not activate under the following conditions:

- A trailer is attached.
- Times of poor visibility, such as snow or heavy rain.
- Poor road conditions.

ESA is part of the FCW system and can not be turned on or off independently.

WARNING!

Evasive Steering Assist (ESA) is not intended to avoid a collision on its own, nor can ESA detect every type of potential collision. The driver has the responsibility to avoid a collision by controlling the vehicle via braking and steering. Failure to follow this warning could lead to serious injury or death.

Pedestrian Emergency Braking (PEB) — If Equipped

PEB is a subsystem of the FCW system that provides the driver with audible and visual warnings in the instrument cluster display, and may apply automatic braking when it detects a potential frontal collision with a pedestrian/cyclist.

If a PEB event begins at a speed below 37 mph (60 km/h), the system may provide braking to mitigate the potential collision with a pedestrian/cyclist. If the PEB event stops the vehicle completely, the system will hold the vehicle at a standstill for two seconds and then release the brakes. When the system determines a collision with the pedestrian/cyclist in front of you is no longer probable, the warning message will be deactivated.

The minimum speed for PEB activation is 3 mph (5 km/h).

WARNING!

Pedestrian Emergency Braking (PEB) is not intended to avoid a collision on its own, nor can PEB detect

(Continued)

WARNING!

every type of potential collision with a pedestrian/cyclist. The driver has the responsibility to avoid a collision by controlling the vehicle via braking and steering. Failure to follow this warning could lead to serious injury or death.

Intersection Collision Assist (ICA) – If Equipped

ICA uses three front radar sensors located in the front fascia/bumper, to detect oncoming vehicles from the front or side when driving through an intersection. When the system determines that a collision is probable when turning across oncoming traffic, the system will attempt to mitigate a possible collision by decelerating the vehicle. When the system determines that a collision with a crossing vehicle is probable, the system may apply additional braking to supplement the driver braking input to attempt to mitigate a possible collision. The system will also provide audible warnings and visual warnings (shown in the instrument cluster). If the driver determines acceleration is needed to avoid a collision, when the accelerator is pressed ICA will cancel.

TIRE PRESSURE MONITORING SYSTEM (TPMS)

TPMS will warn the driver of a low tire pressure based on the vehicle recommended cold placard pressure.

NOTE:

The TPMS Warning Light will illuminate in the instrument cluster and a chime will sound when tire

pressure is low in one or more of the four active road tires. In addition, the instrument cluster will display a graphic showing the pressure values of each tire with the low tire pressure values in a different color, or the Uconnect radio will display a TPMS message; when this occurs you must increase the tire pressure to the recommended cold placard pressure in order for the TPMS Warning Light to turn off.

The tire pressure will vary with temperature by about 1 psi (7 kPa) for every 12°F (6.5°C). This means that when the outside temperature decreases, the tire pressure will decrease. Tire pressure should always be set based on cold inflation tire pressure. This is defined as the tire pressure after the vehicle has not been driven for at least three hours, or driven less than 1 mile (1.6 km) after a three hour period. The cold tire inflation pressure must not exceed the maximum inflation pressure molded into the tire sidewall. The tire pressure will also increase as the vehicle is driven — this is normal and there should be no adjustment for this increased pressure.

See your Owner's Manual on how to properly inflate the vehicle's tires.

The TPMS will warn the driver of a low tire pressure if the tire pressure falls below the low-pressure warning limit for any reason, including low temperature effects and natural pressure loss through the tire.

The TPMS will continue to warn the driver of low tire pressure as long as the condition exists, and will not turn off until the tire pressure is at or above the recommended cold placard pressure. Once the low TPMS Warning Light illuminates, increase the tire pressure to the recommended cold placard pressure in order for the TPMS Warning Light to turn off.

The system will automatically update and the TPMS Warning Light will turn off once the system receives the updated tire pressures. The vehicle may need to be driven for up to 20 minutes above 15 mph (24 km/h) in order for the TPMS to receive this information.

NOTE:

When filling warm tires, the tire pressure may need to be increased up to an additional 4 psi (28 kPa) above the recommended cold placard pressure in order to turn the TPMS Warning Light off.

For example, your vehicle may have a recommended cold (parked for more than three hours) placard pressure of 30 psi (207 kPa). If the ambient temperature is 68°F (20°C) and the measured tire pressure is 27 psi (186 kPa), a temperature drop to 20°F (-7°C) will decrease the tire pressure to approximately 23 psi (158 kPa). This tire pressure is sufficiently low enough to turn on the TPMS Warning Light. Driving the vehicle may cause the tire pressure to rise to approximately 27 psi (186 kPa), but the TPMS Warning Light will still be on. In this situation, the TPMS Warning Light will turn off only after the tires are inflated to the vehicle's recommended cold placard pressure value.

6

CAUTION!

- The TPMS has been optimized for the original equipment tires and wheels. TPMS pressures and warning have been established for the tire size equipped on your vehicle. Undesirable system operation or sensor damage may result when using replacement equipment that is not of the

(Continued)

CAUTION

same size, type, and/or style. Aftermarket wheels can cause sensor damage.

- Using aftermarket tire sealants may cause the Tire Pressure Monitoring System (TPMS) sensor to become inoperable. After using an aftermarket tire sealant it is recommended that you take your vehicle to an authorized dealership to have your sensor function checked.
- After inspecting or adjusting the tire pressure always reinstall the valve stem cap. This will prevent moisture and dirt from entering the valve stem, which could damage the TPMS sensor.

NOTE:

- The TPMS is not intended to replace normal tire care and maintenance or to provide warning of a tire failure or condition.
- The TPMS should not be used as a tire pressure gauge while adjusting your tire pressure, unless your vehicle is equipped with a Tire Fill Alert (TFA) system.
- Driving on a significantly underinflated tire causes the tire to overheat and can lead to tire failure. Underinflation also reduces vehicle range and tire tread life, and may affect the vehicle's handling and stopping ability.
- The TPMS is not a substitute for proper tire maintenance, and it is the driver's responsibility to maintain correct tire pressure using an accurate tire pressure gauge, even if underinflation has not reached the level to trigger illumination of the TPMS Warning Light.

- Seasonal temperature changes will affect tire pressure, and the TPMS will monitor the actual tire pressure in the tire.

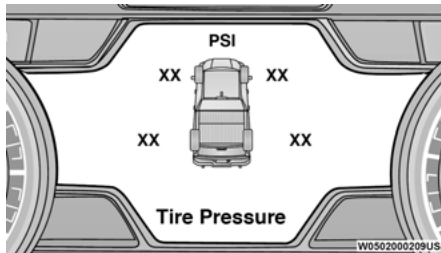
**Tire Pressure Monitoring System Display**

The Tire Pressure Monitoring System (TPMS) uses wireless technology with wheel rim mounted electronic sensors to monitor tire pressure levels. Sensors, mounted to each wheel as part of the valve stem, transmit tire pressure readings to the receiver module.

NOTE:

It is particularly important for you to check the tire pressure in all of the tires on your vehicle monthly and to maintain the proper pressure.

The TPMS consists of the following components:

- Receiver module
- Four Tire Pressure Monitoring System sensors
- Various Tire Pressure Monitoring System messages, which display in the instrument cluster
- Tire Pressure Monitoring System Warning Light

Tire Pressure Monitoring System Low Pressure Warnings

The Tire Pressure Monitoring System (TPMS) Warning Light will illuminate in the instrument cluster and a chime will sound when tire pressure is low in one or more of the four active road tires. In addition, the instrument cluster will display a graphic showing the pressure values of each tire with the low tire pressure values in a different color. An "Inflate to XX" message will also be displayed.

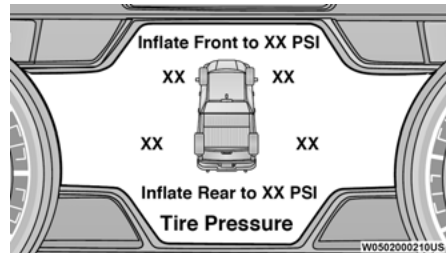
**Low Tire Pressure Display**

Should this occur, you should stop as soon as possible and inflate the tires with a low pressure condition (those in a different color in the instrument cluster graphic) to the vehicle's recommended cold placard pressure inflation value as shown in the "Inflate to XX" message. Once the system receives the updated tire pressures, the system will automatically update, the graphic display in the instrument cluster will return to its original color, and the Tire Pressure Monitoring System Warning Light will turn off. The vehicle may

need to be driven for up to 20 minutes above 15 mph (24 km/h) in order for the TPMS to receive this information.

NOTE:

When filling warm tires, the tire pressure may need to be increased up to an additional 4 psi (28 kPa) above the recommended cold placard pressure in order to turn the Tire Pressure Monitoring System Warning Light off.

Service TPMS Warning

If a system fault is detected, the Tire Pressure Monitoring System (TPMS) Warning Light will flash on and off for 75 seconds and then remain on solid. The system fault will also sound a chime. In addition, the instrument cluster will display a "SERVICE TPM SYSTEM" message for a minimum of five seconds and then display dashes (–) in place of the pressure value to indicate which sensor is not being received.

If the ignition switch is cycled, this sequence will repeat, providing the system fault still exists. If the system fault no longer exists, the Tire Pressure Monitoring System Warning Light will no longer flash, and the "SERVICE TPM SYSTEM" message will no longer display, and a pressure value will display in place of the dashes. A system fault can occur due to any of the following:

- Signal interference due to electronic devices or driving next to facilities emitting the same radio frequencies as the Tire Pressure Monitoring System sensors
- Installing aftermarket window tinting that contains materials that may block radio wave signals

- Accumulation of snow or ice around the wheels or wheel housings
- Using tire chains on the vehicle
- Using wheels/tires not equipped with TPMS sensors

A system fault may occur due to an incorrect TPMS sensor location condition. When a system fault occurs due to an incorrect TPMS sensor location, the Tire Pressure Monitoring System (TPMS) Warning Light will flash on and off for 75 seconds and then remain on solid. The system fault will also sound a chime. In addition, the instrument cluster will display a Tire Pressure Temporarily Unavailable message in place of the tire pressure display screen. If the ignition switch is cycled, this sequence will repeat, providing the system fault still exists. If the system fault no longer exists, the "Tire Pressure Monitoring System Warning Light" will no longer flash and the tire pressure display screen will be displayed showing the tire pressure values the correct locations.

Vehicles With Non-Matching Full Size Spare Or Compact Spare

- The non-matching full size spare or compact spare tire does not have a TPMS sensor. Therefore, the TPMS will not monitor the pressure in the non-matching full size spare or compact spare tire.
- If you install the non-matching full size spare or compact spare tire in place of a road tire that has a pressure below the low-pressure warning limit, upon the next ignition switch cycle, the Tire Pressure Monitoring System (TPMS) Warning Light and a "LOW TIRE" message will remain on and a chime will sound. In addition, the graphic in the instrument

cluster will still display a pressure value in a different color and an "Inflate to XX" message.

- After driving the vehicle for up to 20 minutes above 15 mph (24 km/h), the Tire Pressure Monitoring System (TPMS) Warning Light will flash on and off for 75 seconds and then remain on solid. In addition, the instrument cluster will display a "SERVICE TPM SYSTEM" message for a minimum of five seconds and then display dashes (–) in place of the pressure value.
- For each subsequent ignition switch cycle, a chime will sound, the Tire Pressure Monitoring System (TPMS) Warning Light will flash on and off for 75 seconds and then remain on solid, and the instrument cluster will display a "SERVICE TPM SYSTEM" message for a minimum of five seconds and then display dashes (–) in place of the pressure value.
- Once you repair or replace the original road tire and reinstall it on the vehicle in place of the non-matching full size spare or compact spare, the TPMS will update automatically. In addition, the Tire Pressure Monitoring System (TPMS) Warning Light will turn off and the graphic in the instrument cluster will display a new pressure value instead of dashes (–), as long as no tire pressure is below the low-pressure warning limit in any of the four active road tires. The vehicle may need to be driven for up to 20 minutes above 15 mph (24 km/h) in order for the TPMS to receive this information.

Tire Fill Alert

This feature notifies the user when the placard tire pressure is attained while inflating or deflating the tire.

You may choose to disable or enable the Tire Fill Alert feature through use of the Uconnect Settings in the radio.

NOTE:

- Only one tire can be filled at a time when using the Tire Fill Alert system.
- The Tire Fill Alert feature cannot be entered if an existing TPMS fault is set to “active” or if the system is in deactivation mode (if equipped).

The system will be activated when a positive increase in tire pressure is detected by the TPMS while inflating the tire. The ignition must be in the RUN mode, with the transmission in PARK.

NOTE:

It is not required to have the engine running to enter Tire Fill Alert mode.

The hazard lamps will come on to confirm the vehicle is in Tire Fill Alert mode.

When Tire Fill Alert mode is entered, the tire pressure display screen will be displayed in the instrument cluster.

If the hazard lamps do not come on while inflating the tire, the TPMS sensor may be out of range preventing the TPMS sensor signal from being received. In this case, the vehicle may need to be moved either forward or backward slightly to exit the null spot.

Operation:

- The horn will sound once to let the user know when to stop filling the tire, when it reaches recommended pressure.

- The horn will sound three times if the tire is overfilled and will continue to sound every five seconds if the user continues to inflate the tire.
- The horn will sound once again when enough air is let out to reach proper inflation level.
- The horn will also sound three times if the tire is then underinflated and will continue to sound every five seconds if the user continues to deflate the tire.

Trailer Tire Pressure Monitoring System (TTPMS) – If Equipped

The Trailer Tire Pressure Monitoring System (TTPMS) is a feature that displays the trailer tire pressure values and warns the driver of a low tire pressure event based on the driver’s set target tire pressure value, through TTPMS settings found in the radio.

The TTPMS monitors the pressure of each tire and warns the driver through the instrument cluster, when either a low tire pressure condition falls below 25% of the driver’s set pressure or if a system malfunction occurs. The instrument cluster will display the actual tire pressure or dashes for each of the trailer tires in the correct trailer position, based on trailer configuration. The TTPMS can support up to 12 trailer tires per configured trailer on up to four configurable trailers.

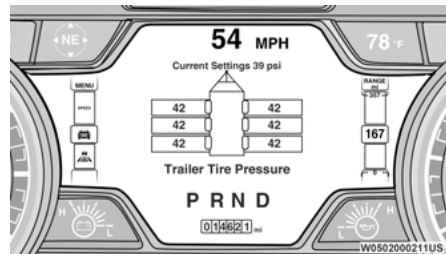

Trailer Tire Pressure Monitoring System

Trailer Tire Pressure Sensor Pairing

In order use this feature, the provided tire pressure sensors must be installed in the desired trailer tires and the sensors must be paired to the truck. If the target trailer requires more than the provided four sensors, additional sensors can be purchased at an authorized Ram dealership.

With the sensors installed and the trailer near or connected to your Ram truck, initiate the pairing process by entering the settings menu in the radio and selecting trailer. Select the desired trailer profile to pair to, open the “Tire Pressure” menu, and hit “Setup All Tires”.

NOTE:

The vehicle may not be driven until the pairing process is complete.



Trailer Tire Pressure Settings



Trailer Tire Pressure Pairing

Follow the on screen prompts to select the number of axles (1-3), the number of trailer tires (2, 4, 6, 8, or 12), and the set trailer tire pressure. The range is selectable anywhere between 25-125 psi (172-862 kPa).

Once psi (kPa) is programmed, the pairing screen appears. Tire sensors must be paired in order shown. Starting with Tire 1, deflate tire by 5 psi (34 kPa) and wait for a horn chirp. It may take up to three minutes for the chirp to occur, indicating that the sensor has paired. Repeat process on each tire, in order, until complete. Do not exit the pairing screen until process is complete. If pairing was unsuccessful, a double horn chirp will sound, and a prompt on the touchscreen will allow you to retry the procedure; "Retry" will only appear when setup fails. Each tire must be successfully paired during a single pairing process to receive the success screen.

NOTE:

If the pairing process times out after three minutes of no communication with a sensor, a double horn chirp will occur indicating the pairing has failed and a message will display on the radio indicating the process was unsuccessful. Under certain circumstances, the double horn chirp may continue to happen every three minutes indicating the failed pairing. If this happens, the horn chirping may be canceled by cycling the ignition button OFF and then back to RUN position.

Tire Pressure Monitoring System Low Pressure Warnings

When a tire pressure low in one or more of the active road tires is detected, the instrument cluster will display a message stating "Trailer Tire Pressure Low". The instrument cluster will then display the TTPMS graphic showing the pressure values of each tire with the low tire pressure values in a different color.

Should this occur, you should stop as soon as possible and inflate the tires with a low pressure condition (those in a different color in the instrument cluster graphic) to the customer programmed target tire

pressure value as shown at the top of the TTPMS instrument cluster graphic. Once the tire(s) are inflated, the system will automatically update the graphic display in the instrument cluster, returning to its original color. The vehicle may need to be driven for up to 10 minutes above 15 mph (24 km/h) in order for the TTPMS to receive the updated information.

Service TTPMS Warning

If a system fault is detected, the instrument cluster will display a "Trailer Tire Pressure System Service Required" message for a minimum of five seconds.

Once the system fault is corrected the "Trailer Tire Pressure System Service Required" message will no longer be displayed. The vehicle may need to be driven for up to 10 minutes above 15 mph (24 km/h) in order for the TTPMS to receive the trailer tire pressure information.

Trailer Tire Pressure System Not Configured

A "Trailer Tire Pressure System Not Configured" message will be displayed in the instrument cluster on the TTPMS instrument cluster graphic when a trailer number is selected that has not had trailer tire pressure sensors paired. To correct this condition, see Uconnect Settings in your Owner's Manual.

Trailer Sensors Detected Do Not Match Active Trailer

The "Trailer Sensors Detected Do Not Match Active Trailer" message will be displayed in the instrument cluster when the trailer sensors being received by the TTPMS module do not match the trailer sensors paired to the current trailer number selected. This message will be displayed when the sensors being received

completely match the sensors paired to another trailer number configured in the TPMS module.

To correct this condition, the correct trailer number must be selected in the radio Uconnect Settings.

OCCUPANT RESTRAINT SYSTEMS

Some of the most important safety features in your vehicle are the restraint systems:

OCCUPANT RESTRAINT SYSTEMS FEATURES

- Seat Belt Systems
- Supplemental Restraint Systems (SRS) Air Bags
- Child Restraints

Some of the safety features described in this section may be standard equipment on some models, or may be optional equipment on others. If you are not sure, ask an authorized dealer.

IMPORTANT SAFETY PRECAUTIONS

Please pay close attention to the information in this section. It tells you how to use your restraint system properly, to keep you and your passengers as safe as possible.

Here are some simple steps you can take to minimize the risk of harm from a deploying air bag:

1. Children 12 years old and under should always ride buckled up in the rear seat of a vehicle with a rear seat.
2. A child who is not big enough to wear the vehicle seat belt properly must be secured in

the appropriate child restraint or belt-positioning booster seat in a rear seating position ⇨ page 317.

3. If a child from 2 to 12 years old (not in a rear-facing child restraint) must ride in the front passenger seat, move the seat as far back as possible and use the proper child restraint ⇨ page 317.
4. Never allow children to slide the shoulder belt behind them or under their arm.
5. You should read the instructions provided with your child restraint to make sure that you are using it properly.
6. All occupants should always wear their lap and shoulder belts properly.
7. The driver and front passenger seats should be moved back as far as practical to allow the front air bags room to inflate.
8. Do not lean against the door or window. If your vehicle has side air bags, and deployment occurs, the side air bags will inflate forcefully into the space between occupants and the door and occupants could be injured.
9. If the air bag system in this vehicle needs to be modified to accommodate a disabled person, see your Owner Handbook for customer service contact information.

WARNING!

- Never place a rear-facing child restraint in front of an air bag. A deploying passenger front air bag can cause death or serious injury to a child 12 years or younger, including a child in a rear-facing child restraint.
- Never install a rear-facing child restraint in the front seat of a vehicle. Only use a rear-facing child restraint in the rear seat. If the vehicle does not have a rear seat, do not transport a rear-facing child restraint in that vehicle.

SEAT BELT SYSTEMS

Buckle up even though you are an excellent driver, even on short trips. Someone on the road may be a poor driver and could cause a collision that includes you. This can happen far away from home or on your own street.

Research has shown that seat belts save lives, and they can reduce the seriousness of injuries in a collision. Some of the worst injuries happen when people are thrown from the vehicle. Seat belts reduce the possibility of ejection and the risk of injury caused by striking the inside of the vehicle. Everyone in a motor vehicle should be belted at all times.

Enhanced Seat Belt Use Reminder System (BeltAlert)

Driver And Passenger BeltAlert – If Equipped



BeltAlert is a feature intended to remind the driver and outboard front seat passenger (if equipped with outboard front passenger seat BeltAlert) to buckle their seat belts.

The BeltAlert feature is active whenever the ignition switch is in the START or ON/RUN position.

Initial Indication

If the driver is unbuckled when the ignition switch is first in the START or ON/RUN position, a chime will signal for a few seconds. If the driver or outboard front seat passenger (if equipped with outboard front passenger seat BeltAlert) is unbuckled when the ignition switch is first in the START or ON/RUN position the Seat Belt Reminder Light will turn on and remain on until both outboard front seat belts are buckled. The outboard front passenger seat BeltAlert is not active when an outboard front passenger seat is unoccupied.

BeltAlert Warning Sequence

The BeltAlert warning sequence is activated when the vehicle is moving above a specified vehicle speed range and the driver or outboard front seat passenger is unbuckled (if equipped with outboard front passenger seat BeltAlert) (the outboard front passenger seat BeltAlert is not active when the outboard front passenger seat is unoccupied). The BeltAlert warning sequence starts by blinking the Seat Belt Reminder Light and sounding an intermittent chime. Once the BeltAlert warning sequence has completed, the Seat Belt Reminder Light will remain on until the seat

belts are buckled. The BeltAlert warning sequence may repeat based on vehicle speed until the driver and occupied outboard front seat passenger seat belts are buckled. The driver should instruct all occupants to buckle their seat belts.

Change Of Status

If the driver or outboard front seat passenger (if equipped with outboard front passenger seat BeltAlert) unbuckles their seat belt while the vehicle is traveling, the BeltAlert warning sequence will begin until the seat belts are buckled again.

The outboard front passenger seat BeltAlert is not active when the outboard front passenger seat is unoccupied. BeltAlert may be triggered when an animal or other items are placed on the outboard front passenger seat or when the seat is folded flat (if equipped). It is recommended that pets be restrained in the rear seat (if equipped) in pet harnesses or pet carriers that are secured by seat belts, and cargo is properly stowed.

BeltAlert can be activated or deactivated by an authorized dealer. FCA US LLC does not recommend deactivating BeltAlert.

NOTE:

If BeltAlert has been deactivated and the driver or outboard front seat passenger (if equipped with outboard front passenger seat BeltAlert) is unbuckled the Seat Belt Reminder Light will turn on and remain on until the driver and outboard front seat passenger seat belts are buckled.

Lap/Shoulder Belts

All seating positions in your vehicle are equipped with lap/shoulder belts.

The seat belt webbing retractor will lock only during very sudden stops or collisions. This feature allows the shoulder part of the seat belt to move freely with you under normal conditions. However, in a collision the seat belt will lock and reduce your risk of striking the inside of the vehicle or being thrown out of the vehicle.

WARNING!

- Relying on the air bags alone could lead to more severe injuries in a collision. The air bags work with your seat belt to restrain you properly. In some collisions, the air bags won't deploy at all. Always wear your seat belt even though you have air bags.
- In a collision, you and your passengers can suffer much greater injuries if you are not properly buckled up. You can strike the interior of your vehicle or other passengers, or you can be thrown out of the vehicle. Always be sure you and others in your vehicle are buckled up properly.
- It is dangerous to ride in a cargo area, inside or outside of a vehicle. In a collision, people riding in these areas are more likely to be seriously injured or killed.
- Do not allow people to ride in any area of your vehicle that is not equipped with seats and seat belts.

(Continued)

WARNING!

- Be sure everyone in your vehicle is in a seat and using a seat belt properly. Occupants, including the driver, should always wear their seat belts whether or not an air bag is also provided at their seating position to minimize the risk of severe injury or death in the event of a crash.
- Wearing your seat belt incorrectly could make your injuries in a collision much worse. You might suffer internal injuries, or you could even slide out of the seat belt. Follow these instructions to wear your seat belt safely and to keep your passengers safe, too.
- Two people should never be belted into a single seat belt. People belted together can crash into one another in a collision, hurting one another badly. Never use a lap/shoulder belt or a lap belt for more than one person, no matter what their size.

WARNING!

- A lap belt worn too high can increase the risk of injury in a collision. The seat belt forces won't be at the strong hip and pelvic bones, but across your abdomen. Always wear the lap part of your seat belt as low as possible and keep it snug.
- A twisted seat belt may not protect you properly. In a collision, it could even cut into you. Be sure the seat belt is flat against your body, without twists. If you can't straighten a seat belt in your vehicle,

*(Continued)***WARNING!**

take it to an authorized dealer immediately and have it fixed.

- A seat belt that is buckled into the wrong buckle will not protect you properly. The lap portion could ride too high on your body, possibly causing internal injuries. Always buckle your seat belt into the buckle nearest you.
- A seat belt that is too loose will not protect you properly. In a sudden stop, you could move too far forward, increasing the possibility of injury. Wear your seat belt snugly.
- A seat belt that is worn under your arm is dangerous. Your body could strike the inside surfaces of the vehicle in a collision, increasing head and neck injury. A seat belt worn under the arm can cause internal injuries. Ribs aren't as strong as shoulder bones. Wear the seat belt over your shoulder so that your strongest bones will take the force in a collision.
- A shoulder belt placed behind you will not protect you from injury during a collision. You are more likely to hit your head in a collision if you do not wear your shoulder belt. The lap and shoulder belt are meant to be used together.
- A frayed or torn seat belt could rip apart in a collision and leave you with no protection. Inspect the seat belt system periodically, checking for cuts, frays, or loose parts. Damaged parts must be replaced immediately. Do not disassemble or modify the seat belt system. If your vehicle is involved in a collision, or if you have questions

*(Continued)***WARNING!**

regarding seat belt or retractor conditions, take your vehicle to an authorized FCA US LLC dealer or authorized FCA US LLC Certified Collision Care Program facility for inspection.

Lap/Shoulder Belt Operating Instructions

1. Enter the vehicle and close the door. Sit back and adjust the seat.
2. The seat belt latch plate is above the back of the front seat, and next to your arm in the rear seat (for vehicles equipped with a rear seat). Grab the latch plate and pull out the seat belt. Slide the latch plate up the webbing as far as necessary to allow the seat belt to go around your lap.

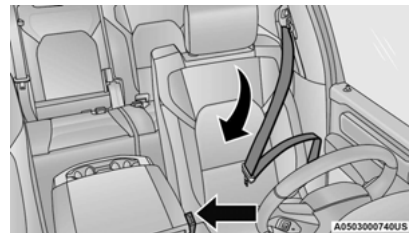
**Pulling Out The Latch Plate**

- When the seat belt is long enough to fit, insert the latch plate into the buckle until you hear a “click.”



Inserting Latch Plate Into Buckle

- Position the lap belt so that it is snug and lies low across your hips, below your abdomen. To remove slack in the lap belt portion, pull up on the shoulder belt. To loosen the lap belt if it is too tight, tilt the latch plate and pull on the lap belt. A snug seat belt reduces the risk of sliding under the seat belt in a collision.

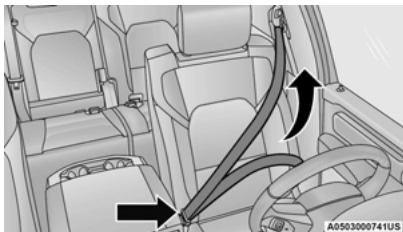

Positioning The Lap Belt

- Position the shoulder belt across the shoulder and chest with minimal, if any slack so that it is comfortable and not resting on your neck. The retractor will withdraw any slack in the shoulder belt.
- To release the seat belt, push the red button on the buckle. The seat belt will automatically retract to its stowed position. If necessary, slide the latch plate down the webbing to allow the seat belt to retract fully.

Lap/Shoulder Belt Untwisting Procedure

Use the following procedure to untwist a twisted lap/shoulder belt.

- Position the latch plate as close as possible to the anchor point.
- At about 6 to 12 inches (15 to 30 cm) above the latch plate, grab and twist the seat belt webbing 180 degrees to create a fold that begins immediately above the latch plate.
- Slide the latch plate upward over the folded webbing. The folded webbing must enter the slot at the top of the latch plate.
- Continue to slide the latch plate up until it clears the folded webbing and the seat belt is no longer twisted.

Adjustable Upper Shoulder Belt Anchorage

In the driver and outboard front passenger seats, the top of the shoulder belt can be adjusted upward or downward to position the seat belt away from your

neck. Push or squeeze the anchorage button to release the anchorage, and move it up or down to the position that serves you best.

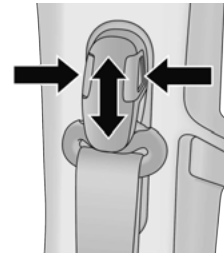

Adjustable Anchorage

As a guide, if you are shorter than average, you will prefer the shoulder belt anchorage in a lower position, and if you are taller than average, you will prefer the shoulder belt anchorage in a higher position. After you release the anchorage button, try to move it up or down to make sure that it is locked in position.

NOTE:

The adjustable upper shoulder belt anchorage is equipped with an Easy Up feature. This feature allows the shoulder belt anchorage to be adjusted in the upward position without pushing or squeezing the release button. To verify the shoulder belt anchorage is latched, pull downward on the shoulder belt anchorage until it is locked into position.

WARNING!

- Wearing your seat belt incorrectly could make your injuries in a collision much worse. You might suffer internal injuries, or you could even slide out of the seat belt. Follow these instructions to wear your seat belt safely and to keep your passengers safe, too.
- Position the shoulder belt across the shoulder and chest with minimal, if any slack so that it is comfortable and not resting on your neck. The retractor will withdraw any slack in the shoulder belt.
- Misadjustment of the seat belt could reduce the effectiveness of the safety belt in a crash.
- Always make all seat belt height adjustments when the vehicle is stationary.

Seat Belt Extender

If a seat belt is not long enough to fit properly, even when the webbing is fully extended and the adjustable upper shoulder belt anchorage (if equipped) is in its lowest position, an authorized dealer can provide you with a Seat Belt Extender. The Seat Belt Extender should be used only if the existing seat belt is not long enough. When the Seat Belt Extender is not required for a different occupant, it must be removed.

WARNING!

- **ONLY** use a Seat Belt Extender if it is physically required in order to properly fit the original seat

(Continued)

WARNING!

- belt system. **DO NOT USE** the Seat Belt Extender if, when worn, the distance between the front edge of the Seat Belt Extender buckle and the center of the occupant's body is **LESS** than 6 inches.
- Using a Seat Belt Extender when not needed can increase the risk of serious injury or death in a collision. Only use the Seat Belt Extender when the lap belt is not long enough and only use in the recommended seating positions. Remove and store the Seat Belt Extender when not needed.

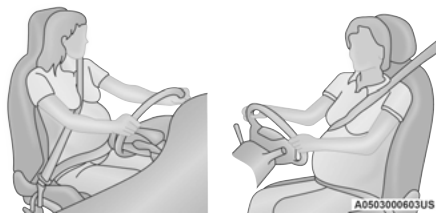
Seat Belts And Pregnant Women**Seat Belts And Pregnant Women**

Seat belts must be worn by all occupants including pregnant women: the risk of injury in the event of an accident is reduced for the mother and the unborn child if they are wearing a seat belt.

Position the lap belt snug and low below the abdomen and across the strong bones of the hips. Place the shoulder belt across the chest and away from the neck.

Never place the shoulder belt behind the back or under the arm.

Seat Belt Pretensioner

The front and second row outboard seat belt systems are equipped with pretensioning devices that are designed to remove slack from the seat belt in the event of a collision. These devices may improve the performance of the seat belt by removing slack from the seat belt early in a collision. Pretensioners work for all size occupants, including those in child restraints.

NOTE:

These devices are not a substitute for proper seat belt placement by the occupant. The seat belt still must be worn snugly and positioned properly.

The pretensioners are triggered by the Occupant Restraint Controller (ORC). Like the air bags, the pretensioners are single use items. A deployed pretensioner or a deployed air bag must be replaced immediately.

Energy Management Feature

The front and second row outboard seat belt systems are equipped with an Energy Management feature that may help further reduce the risk of injury in the event of a collision. The seat belt system has a retractor assembly that is designed to release webbing in a controlled manner.

Switchable Automatic Locking Retractors (ALR)

The seat belts in the passenger seating positions are equipped with a Switchable Automatic Locking

Retractor (ALR) which is used to secure a child restraint system → page 324. The figure below illustrates the locking feature for each seating position.

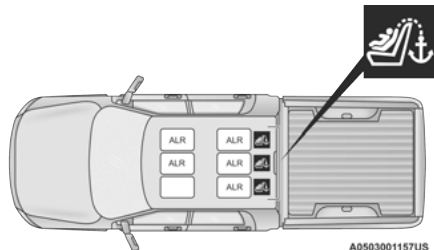

Automatic Locking Retractor — (ALR) Locations (All Models)

If the passenger seating position is equipped with an ALR and is being used for normal usage, only pull the seat belt webbing out far enough to comfortably wrap around the occupant's mid-section so as to not activate the ALR. If the ALR is activated, you will hear a clicking sound as the seat belt retracts. Allow the webbing to retract completely in this case and then carefully pull out only the amount of webbing necessary to comfortably wrap around the occupant's mid-section. Slide the latch plate into the buckle until you hear a "click."

In Automatic Locking Mode, the shoulder belt is automatically pre-locked. The seat belt will still retract to remove any slack in the shoulder belt. Use the Automatic Locking Mode anytime a child restraint is installed in a seating position that has a seat belt with this feature. Children 12 years old and under should

always be properly restrained in the rear seat of a vehicle with a rear seat.

WARNING!

- Never place a rear-facing child restraint in front of an air bag. A deploying passenger front air bag can cause death or serious injury to a child 12 years or younger, including a child in a rear-facing child restraint.
- Never install a rear-facing child restraint in the front seat of a vehicle. Only use a rear-facing child restraint in the rear seat. If the vehicle does not have a rear seat, do not transport a rear-facing child restraint in that vehicle.

How To Engage The Automatic Locking Mode

1. Buckle the combination lap and shoulder belt.
2. Grab the shoulder portion and pull downward until the entire seat belt is extracted.
3. Allow the seat belt to retract. As the seat belt retracts, you will hear a clicking sound. This indicates the seat belt is now in the Automatic Locking Mode.

How To Disengage The Automatic Locking Mode

Unbuckle the combination lap/shoulder belt and allow it to retract completely to disengage the Automatic Locking Mode and activate the vehicle sensitive (emergency) locking mode.

WARNING!

- The seat belt assembly must be replaced if the switchable Automatic Locking Retractor (ALR) feature or any other seat belt function is not working properly when checked according to the procedures in the Service Manual.
- Failure to replace the seat belt assembly could increase the risk of injury in collisions.
- Do not use the Automatic Locking Mode to restrain occupants who are wearing the seat belt or children who are using booster seats. The locked mode is only used to install rear-facing or forward-facing child restraints that have a harness for restraining the child.

SUPPLEMENTAL RESTRAINT SYSTEMS (SRS)

Some of the safety features described in this section may be standard equipment on some models, or may be optional equipment on others. If you are not sure, ask an authorized dealer.

The air bag system must be ready to protect you in a collision. The Occupant Restraint Controller (ORC) monitors the internal circuits and interconnecting wiring associated with the electrical Air Bag System Components. Your vehicle may be equipped with the following Air Bag System Components:

Air Bag System Components

- Occupant Restraint Controller (ORC)
- Air Bag Warning Light 
- Steering Wheel and Column

- Instrument Panel
- Knee Impact Bolsters
- Driver and Front Passenger Air Bags
- Seat Belt Buckle Switch
- Supplemental Side Air Bags
- Front and Side Impact Sensors
- Seat Belt Pretensioners
- Seat Track Position Sensors
- Occupant Classification System

Air Bag Warning Light



The Occupant Restraint Controller (ORC) monitors the readiness of the electronic parts of the air bag system whenever the power button is in the START or ON/RUN position. If the power button is in the OFF position, the air bag system is not on and the air bags will not inflate.

The ORC contains a backup power supply system that may deploy the air bag system even if the battery loses power or it becomes disconnected prior to deployment.

The ORC turns on the Air Bag Warning Light in the instrument panel for approximately two to eight seconds for a self-check when the Power Button is first in the ON/RUN position. After the self-check, the Air Bag Warning Light will turn off. If the ORC detects a malfunction in any part of the system, it turns on the Air Bag Warning Light, either momentarily or continuously. A single chime will sound to alert you if the light comes on again after initial startup.

The ORC also includes diagnostics that will illuminate the instrument panel Air Bag Warning Light if a malfunction is detected that could affect the air bag system. The diagnostics also record the nature of the malfunction. While the air bag system is designed to be maintenance free, if any of the following occurs, have an authorized dealer service the air bag system immediately.

- The Air Bag Warning Light does not come on during the two to eight seconds when the power button is first in the ON/RUN position.
- The Air Bag Warning Light remains on after the two to eight-second interval.
- The Air Bag Warning Light comes on intermittently or remains on while driving.

NOTE:

If the speedometer, tachometer, or any Electric motor/engine related gauges are not working, the Occupant Restraint Controller (ORC) may also be disabled. In this condition the air bags may not be ready to inflate for your protection. Have an authorized dealer service the air bag system immediately.

WARNING!

Ignoring the Air Bag Warning Light in your instrument panel could mean you won't have the air bag system to protect you in a collision. If the light does not come on as a bulb check when the Power Button is first turned on, stays on after you start the vehicle, or if it comes on as you drive, have an authorized dealer service the air bag system immediately.

Redundant Air Bag Warning Light



If a fault with the Air Bag Warning Light is detected, which could affect the Supplemental Restraint System (SRS), the Redundant Air Bag Warning Light will illuminate on the instrument panel. The Redundant Air Bag Warning Light will stay on until the fault is cleared. In addition, a single chime will sound to alert you that the Redundant Air Bag Warning Light has come on and a fault has been detected. If the Redundant Air Bag Warning Light comes on intermittently or remains on while driving have an authorized dealer service the vehicle immediately.

Front Air Bags

This vehicle has front air bags and lap/shoulder belts for both the driver and front passenger. The front air bags are a supplement to the seat belt restraint systems. The driver front air bag is mounted in the center of the steering wheel. The passenger front air bag is mounted in the instrument panel, above the glove compartment. The words "SRS AIRBAG" or "AIRBAG" are embossed on the air bag covers.

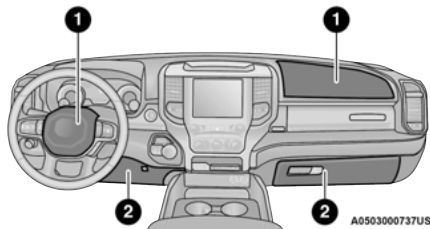

Front Air Bag/Knee Bolster Locations

- 1 — Driver And Passenger Front Air Bags
2 — Driver And Passenger Knee Impact Bolsters

WARNING!

- Being too close to the steering wheel or instrument panel during front air bag deployment could cause serious injury, including death. Air bags need room to inflate. Sit back, comfortably extending your arms to reach the steering wheel or instrument panel.
- Never place a rear-facing child restraint in front of an air bag. A deploying passenger front air bag can cause death or serious injury to a child 12 years or younger, including a child in a rear-facing child restraint.
- Never install a rear-facing child restraint in the front seat of a vehicle. Only use a rear-facing child restraint in the rear seat. If the vehicle does not have a rear seat, do not transport a rear-facing child restraint in that vehicle.

Driver And Passenger Front Air Bag Features

The Advanced Front Air Bag system has multistage driver and front passenger air bags. This system provides output appropriate to the severity and type of collision as determined by the Occupant Restraint Controller (ORC), which may receive information from the front impact sensors (if equipped) or other system components.

The first stage inflator is triggered immediately during an impact that requires air bag deployment. A low energy output is used in less severe collisions. A higher energy output is used for more severe collisions.

This vehicle may be equipped with a driver and/or front passenger seat belt buckle switch that detects whether the driver or front passenger seat belt is buckled. The seat belt buckle switch may adjust the inflation rate of the Advanced Front Air Bags.

This vehicle may be equipped with driver and/or front passenger seat track position sensors that may adjust the inflation rate of the Advanced Front Air Bags based upon seat position.

This vehicle is equipped with a right front passenger Occupant Classification System (“OCS”) that is designed to provide Passenger Advanced Front Air Bag output appropriate to the occupant’s seated weight input, as determined by the OCS.

WARNING!

- No objects should be placed over or near the air bag on the instrument panel or steering wheel because any such objects could cause harm if the vehicle is in a collision severe enough to cause the air bag to inflate.
- Do not put anything on or around the air bag covers or attempt to open them manually. You may damage the air bags and you could be injured because the air bags may no longer be functional. The protective covers for the air bag cushions are designed to open only when the air bags are inflating.
- Relying on the air bags alone could lead to more severe injuries in a collision. The air bags work with your seat belt to restrain you properly. In some collisions, air bags won’t deploy at all. Always wear your seat belts even though you have air bags.

6

Front Air Bag Operation

Front Air Bags are designed to provide additional protection by supplementing the seat belts. Front air bags are not expected to reduce the risk of injury in rear, side, or rollover collisions. The front air bags will not deploy in all frontal collisions, including some that may produce substantial vehicle damage — for example, some pole collisions, truck underrides, and angle offset collisions.

On the other hand, depending on the type and location of impact, front air bags may deploy in crashes with little vehicle front-end damage but that produce a severe initial deceleration.

Because air bag sensors measure vehicle deceleration over time, vehicle speed and damage by themselves are not good indicators of whether or not an air bag should have deployed.

Seat belts are necessary for your protection in all collisions, and also are needed to help keep you in position, away from an inflating air bag.

When the Occupant Restraint Controller (ORC) detects a collision requiring the front air bags, it signals the inflator units. A large quantity of non-toxic gas is generated to inflate the front air bags.

The steering wheel hub trim cover and the upper passenger side of the instrument panel separate and fold out of the way as the air bags inflate to their full size. The front air bags fully inflate in less time than it takes to blink your eyes. The front air bags then quickly deflate while helping to restrain the driver and front passenger.

Occupant Classification System (OCS) — Front Passenger Seat

The Occupant Classification System (OCS) is part of a Federally regulated safety system for this vehicle. It is designed to provide Passenger Advanced Front Air Bag output appropriate to the occupant's seated weight, as determined by the OCS.

The Occupant Classification System (OCS) consists of the following:

- Occupant Restraint Controller (ORC)
- Occupant Classification Module (OCM) and Sensor located in the front passenger seat
- Air Bag Warning Light 

Occupant Classification Module (OCM) And Sensor

The Occupant Classification Module (OCM) is located underneath the front passenger seat. The Sensor is located beneath the passenger seat cushion foam. Any weight on the seat will be sensed by the Sensor. The OCM uses input from the Sensor to determine the front passenger's most probable classification. The OCM communicates this information to the ORC. The ORC may reduce the inflation rate of the Passenger Advanced Front Air Bag deployment based on occupant classification. In order for the OCS to operate as designed, it is important for the front passenger to be seated properly and properly wearing the seat belt.

The OCS will NOT prevent deployment of the Passenger Advanced Front Air Bag. The OCS may reduce the inflation rate of the Passenger Advanced Front Air Bag if the OCS estimates that:

- The front passenger seat is unoccupied or has very light objects on it; or
- The front passenger seat is occupied by a small passenger, including a child; or
- The front passenger seat is occupied by a rear-facing child restraint; or
- The front passenger is not properly seated or his or her weight is taken off of the seat for a period of time.

Front Passenger Seat Occupant Status	Front Passenger Air Bag Output
Rear-facing child restraint	Reduced-power deployment
Child, including a child in a forward-facing child restraint or booster seat*	Reduced-power deployment OR full-power deployment
Properly seated adult	Full-power deployment OR reduced-power deployment
Unoccupied seat	Reduced-power deployment

* It is possible for a child to be classified as an adult, allowing a full-power Passenger Advanced Front Air Bag deployment. Never allow children to ride in the front passenger seat and never install a child restraint system, including a rear-facing child restraint, in the front passenger seat.

WARNING!
<ul style="list-style-type: none"> ● Never place a rear-facing child restraint in front of an air bag. A deploying passenger front air bag can cause death or serious injury to a child 12 years or younger, including a child in a rear-facing child restraint.

(Continued)

WARNING!

- Never install a rear-facing child restraint in the front seat of a vehicle. Only use a rear-facing child restraint in the rear seat. If the vehicle does not have a rear seat, do not transport a rear-facing child restraint in that vehicle.
- Children 12 years or younger should always ride buckled up in the rear seat of a vehicle with a rear seat.

The OCS determines the front passenger's most probable classification. The OCS estimates the seated weight on the front passenger seat and where that weight is located. The OCS communicates the classification status to the ORC. The ORC uses the classification to determine whether the Passenger Advanced Front Air Bag inflation rate should be adjusted.

In order for the OCS to operate as designed, it is important for the front passenger to be seated properly and properly wearing the seat belt. Properly seated passengers are:

- Sitting upright
- Facing forward
- Sitting in the center of the seat with their feet comfortably on or near the floor
- Sitting with their back against the seatback and the seatback in an upright position

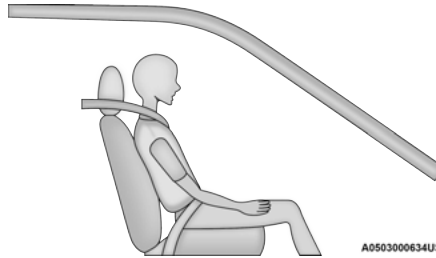

Seated Properly

Lighter Weight Passengers (Including Small Adults)

When a lighter weight passenger, including a small adult, occupies the front passenger seat, the OCS may reduce the inflation rate of the Passenger Advanced Front Air Bag. This does not mean that the OCS is working improperly.

Do not decrease OR increase the front passenger's seated weight on the front passenger seat.

The front passenger's seated weight must be properly positioned on the front passenger seat. Failure to do so may result in serious injury or death. The OCS determines the most probable classification of the occupant that it detects. The OCS will detect the front passenger's decreased or increased seated weight, which may result in an adjusted inflation rate of the Passenger Advanced Front Air Bag in a collision. This does not mean that the OCS is working improperly. Decreasing the front passenger's seated weight on the front passenger seat may result in a reduced-power deployment of the Passenger Advanced Front Air Bag. Increasing the front passenger's seated weight on

the front passenger seat may result in a full-power deployment of the Passenger Advanced Front Air Bag.

Examples of improper front passenger seating include:

- The front passenger's weight is transferred to another part of the vehicle (like the door, arm rest or instrument panel).
- The front passenger leans forward, sideways, or turns to face the rear of the vehicle.
- The front passenger's seatback is not in the full upright position.
- The front passenger carries or holds an object while seated (e.g., backpack, box, etc.).
- Objects are lodged under the front passenger seat.
- Objects are lodged between the front passenger seat and center console.
- Accessories that may change the seated weight on the front passenger seat are attached to the front passenger seat.
- Anything that may decrease or increase the front passenger's seated weight.

The OCS determines the front passenger's most probable classification. If an occupant in the front passenger seat is seated improperly, the occupant may provide an output signal to the OCS that is different from the occupant's properly seated weight input, for example:

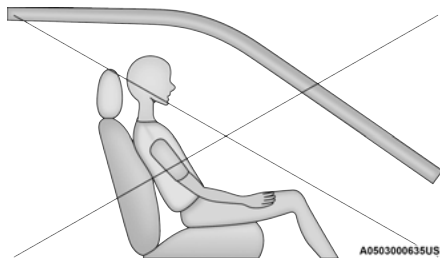

A0503000635US

Not Seated Properly

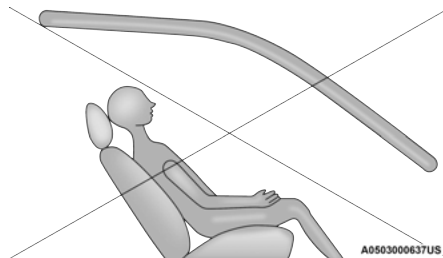

A0503000637US

Not Seated Properly

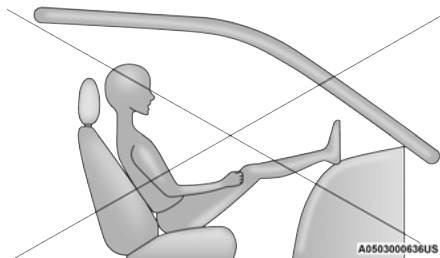

A0503000636US

Not Seated Properly

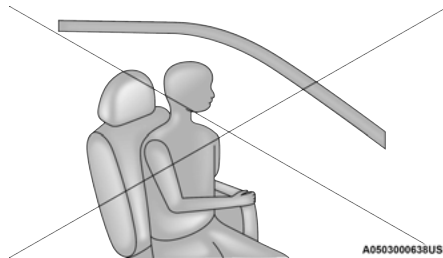

A0503000638US

Not Seated Properly

WARNING!

occupant's properly seated weight input. This may result in serious injury or death in a collision.

- Always wear your seat belt and sit properly, with the seatback in an upright position, your back against the seatback, sitting upright, facing forward, in the center of the seat, with your feet comfortably on or near the floor.
- Do not carry or hold any objects (e.g., backpacks, boxes, etc.) while seated in the front passenger seat. Holding an object may provide an output signal to the OCS that is different than the occupant's properly seated weight input, which may result in serious injury or death in a collision.
- Placing an object on the floor under the front passenger seat may prevent the OCS from working properly, which may result in serious injury or death in a collision. Do not place any objects on the floor under the front passenger seat.

The Air Bag Warning Light  in the instrument panel will turn on whenever the OCS is unable to classify the front passenger seat status. A malfunction in the OCS may affect the operation of the air bag system.

If the Air Bag Warning Light  does not come on, or stays on after you start the vehicle, or it comes on as you drive, take the vehicle to an authorized dealer for service immediately.

The passenger seat assembly contains critical OCS components that may affect the Passenger Advanced Front Air Bag inflation. In order for the OCS to properly classify the seated weight of a front seat passenger, the OCS components must function as designed. Do

WARNING!

- If a child restraint system, child, small teenager or adult in the front passenger seat is seated improperly, the occupant may provide an output signal to the OCS that is different from the

(Continued)

not make any modifications to the front passenger seat components, assembly, or to the seat cover. If the seat, trim cover, or cushion needs service for any reason, take the vehicle to an authorized dealer. Only FCA US LLC approved seat accessories may be used.

The following requirements must be strictly followed:

- Do not modify the front passenger seat assembly or components in any way.
- Do not use prior or future model year seat covers or cushions not designated by FCA US LLC for the specific model being repaired. Always use the correct seat cover and cushion specified for the vehicle.
- Do not replace the seat cover or cushion with an aftermarket seat cover or cushion.
- Do not add a secondary seat cover or mat.
- At no time should any Supplemental Restraint System (SRS) component or SRS related component or fastener be modified or replaced with any part except those which are approved by FCA US LLC.

WARNING!

- Unapproved modifications or service procedures to the passenger seat assembly, its related components, seat cover or cushion may inadvertently change the air bag deployment in case of a frontal collision. This could result in death or serious injury to the front passenger if the vehicle is involved in a collision. A modified vehicle may not comply with required

(Continued)

WARNING!

Federal Motor Vehicle Safety Standards (FMVSS) and/or Canadian Motor Vehicle Safety Standards (CMVSS).

- If it is necessary to modify the air bag system for persons with disabilities, contact an authorized dealer.

Knee Impact Bolsters

The Knee Impact Bolsters help protect the knees of the driver and front passenger, and position the front occupants for improved interaction with the front air bags.

WARNING!

- Do not drill, cut, or tamper with the knee impact bolsters in any way.
- Do not mount any accessories to the knee impact bolsters such as alarm lights, stereos, citizen band radios, etc.

Supplemental Side Air Bags

Supplemental Seat-Mounted Side Air Bags (SABs)

This vehicle is equipped with Supplemental Seat-Mounted Side Air Bags (SABs).

Supplemental Seat-Mounted Side Air Bags (SABs) are located in the outboard side of the front seats. The SABs are marked with "SRS AIRBAG" or "AIRBAG" on a label or on the seat trim on the outboard side of the seats.

The SABs may help to reduce the risk of occupant injury during certain side impacts, in addition to the injury reduction potential provided by the seat belts and body structure.

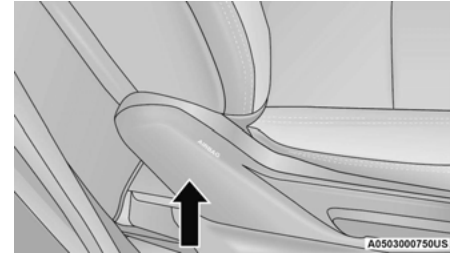

Supplemental Seat-Mounted Side Air Bag Label

When the SAB deploys, it opens the seam on the outboard side of the seatback's trim cover. The inflating SAB deploys through the seat seam into the space between the occupant and the door. The SAB moves at a very high speed and with such a high force that it could injure occupants if they are not seated properly, or if items are positioned in the area where the SAB inflates. Children are at an even greater risk of injury from a deploying air bag.

WARNING!

Do not use accessory seat covers or place objects between you and the Side Air Bags; the performance could be adversely affected and/or objects could be pushed into you, causing serious injury.

Supplemental Side Air Bag Inflatable Curtains (SABICs)

This vehicle is equipped with Supplemental Side Air Bag Inflatable Curtains (SABICs).

Supplemental Side Air Bag Inflatable Curtains (SABICs) are located above the side windows. The trim covering the SABICs is labeled “SRS AIRBAG” or “AIRBAG.”

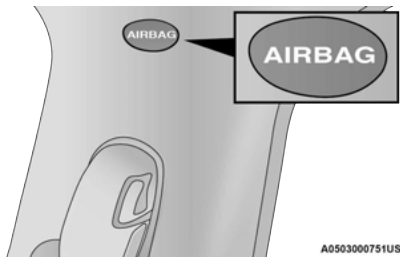

Supplemental Side Air Bag Inflatable Curtain (SABIC) Label Location

SABICs may help reduce the risk of head and other injuries to front and rear seat outboard occupants in certain side impacts, in addition to the injury reduction potential provided by the seat belts and body structure.

The SABIC deploys downward, covering the side windows. An inflating SABIC pushes the outside edge of the headliner out of the way and covers the window. The SABICs inflate with enough force to injure occupants if they are not belted and seated properly, or if items are positioned in the area where the SABICs inflate. Children are at an even greater risk of injury from a deploying air bag.

The SABICs may help reduce the risk of partial or complete ejection of vehicle occupants through side windows in certain side impact events.

WARNING!

- Do not mount equipment, or stack luggage or other cargo up high enough to block the deployment of the SABICs. The trim covering above the side windows where the SABIC and its deployment path are located should remain free from any obstructions.
- In order for the SABICs to work as intended, do not install any accessory items in your vehicle which could alter the roof. Do not add an aftermarket sunroof to your vehicle. Do not add roof racks that require permanent attachments (bolts or screws) for installation on the vehicle roof. Do not drill into the roof of the vehicle for any reason.

Side Impacts

The Side Air Bags are designed to activate in certain side impacts. The Occupant Restraint Controller (ORC) determines whether the deployment of the Side Air Bags in a particular impact event is appropriate, based on the severity and type of collision. The side impact sensors aid the ORC in determining the appropriate response to impact events. The system is calibrated to deploy the Side Air Bags on the impact side of the vehicle during impacts that require Side Air Bag occupant protection. In side impacts, the Side Air Bags deploy independently; a left side impact deploys the left Side Air Bags only and a right-side impact deploys the right Side Air Bags only. Vehicle damage by itself is not

a good indicator of whether or not Side Air Bags should have deployed.

The Side Air Bags will not deploy in all side collisions, including some collisions at certain angles, or some side collisions that do not impact the area of the passenger compartment. The Side Air Bags may deploy during angled or offset frontal collisions where the front air bags deploy.

Side Air Bags are a supplement to the seat belt restraint system. Side Air Bags deploy in less time than it takes to blink your eyes.

WARNING!

- Occupants, including children, who are up against or very close to Side Air Bags can be seriously injured or killed. Occupants, including children, should never lean on or sleep against the door, side windows, or area where the side air bags inflate, even if they are in an infant or child restraint.
- Seat belts (and child restraints where appropriate) are necessary for your protection in all collisions. They also help keep you in position, away from an inflating Side Air Bag. To get the best protection from the Side Air Bags, occupants must wear their seat belts properly and sit upright with their backs against the seats. Children must be properly restrained in a child restraint or booster seat that is appropriate for the size of the child.

WARNING!

- Side Air Bags need room to inflate. Do not lean against the door or window. Sit upright in the center of the seat.
- Being too close to the Side Air Bags during deployment could cause you to be severely injured or killed.
- Relying on the Side Air Bags alone could lead to more severe injuries in a collision. The Side Air Bags work with your seat belt to restrain you properly. In some collisions, Side Air Bags won't deploy at all. Always wear your seat belt even though you have Side Air Bags.

NOTE:

Air bag covers may not be obvious in the interior trim, but they will open during air bag deployment.

Rollover Events

Side Air Bags and seat belt pretensioners are designed to activate in certain rollover events. The Occupant Restraint Controller (ORC) determines whether deployment in a particular rollover event is appropriate, based on the severity and type of collision. Vehicle damage by itself is not a good indicator of whether or not Side Air Bags and seat belt pretensioners should have deployed.

The Side Air Bags and seat belt pretensioners will not deploy in all rollover events. The rollover sensing system determines if a rollover event may be in progress and whether deployment is appropriate. In the event the vehicle experiences a rollover or near rollover event, and deployment is appropriate, the rollover sensing

system will deploy the side air bags and seat belt pretensioners on both sides of the vehicle.

The SABICs may help reduce the risk of partial or complete ejection of vehicle occupants through side windows in certain rollover or side impact events.

Air Bag System Components**NOTE:**

The Occupant Restraint Controller (ORC) monitors the internal circuits and interconnecting wiring associated with electrical Air Bag System Components listed below:

- Occupant Restraint Controller (ORC)
- Air Bag Warning Light 
- Steering Wheel and Column
- Instrument Panel
- Knee Impact Bolsters
- Driver and Front Passenger Air Bags
- Seat Belt Buckle Switch
- Supplemental Side Air Bags
- Front and Side Impact Sensors
- Seat Belt Pretensioners
- Seat Track Position Sensors
- Occupant Classification System

If A Deployment Occurs

The front air bags are designed to deflate immediately after deployment.

NOTE:

Front and/or side air bags will not deploy in all collisions. This does not mean something is wrong with the air bag system.

If you do have a collision which deploys the air bags, any or all of the following may occur:

- The air bag material may sometimes cause abrasions and/or skin reddening to the occupants as the air bags deploy and unfold. The abrasions are similar to friction rope burns or those you might get sliding along a carpet or gymnasium floor. They are not caused by contact with chemicals. They are not permanent and normally heal quickly. However, if you haven't healed significantly within a few days, or if you have any blistering, see your doctor immediately.
- As the air bags deflate, you may see some smoke-like particles. The particles are a normal by-product of the process that generates the non-toxic gas used for air bag inflation. These airborne particles may irritate the skin, eyes, nose, or throat. If you have skin or eye irritation, rinse the area with cool water. For nose or throat irritation, move to fresh air. If the irritation continues, see your doctor. If these particles settle on your clothing, follow the garment manufacturer's instructions for cleaning.

Do not drive your vehicle after the air bags have deployed. If you are involved in another collision, the air bags will not be in place to protect you.

WARNING!

Deployed air bags and seat belt pretensioners cannot protect you in another collision. Have the air bags, seat belt pretensioners, and the seat belt retractor assemblies replaced by an authorized dealer immediately. Also, have the Occupant Restraint Controller System serviced as well.

NOTE:

- Air bag covers may not be obvious in the interior trim, but they will open during air bag deployment.
- After any collision, the vehicle should be taken to an authorized dealer immediately.

Enhanced Accident Response System

In the event of an impact, if the communication network remains intact, and the power remains intact, depending on the nature of the event, the Occupant Restraint Controller (ORC) will determine whether to have the Enhanced Accident Response System perform the following functions:

- Cut off fuel to the engine (if equipped)
- Cut off battery power to the electric motor (if equipped)
- Flash hazard lights as long as the battery has power
- Turn on the interior lights, which remain on as long as the battery has power or for 15 minutes from the intervention of the Enhanced Accident Response System
- Unlock the power door locks

Your vehicle may also be designed to perform any of these other functions in response to the Enhanced Accident Response System:

- Turn off the HVAC Blower Motor and Close the HVAC Circulation Door
- Cut off battery power to the:
 - Engine (if equipped)
 - Electric Motor (if equipped)
 - Electric power steering
 - Brake booster
 - Electric park brake
 - Automatic gear selector
 - Horn
 - Front wiper

NOTE:

After an accident, place the Power Button to the STOP (OFF) position to avoid draining the battery. Carefully check the vehicle for leaks in the Underhood Compartment and on the ground near the Underhood Compartment before resetting the system. If there are no leaks or damage to the vehicle electrical devices (e.g. headlights) after an accident, reset the system by following the procedure described below. If you have any doubt, contact an authorized dealer.

Enhanced Accident Response System Reset Procedure (GAS)

In order to reset the Enhanced Accident Response System functions after an event, the ignition switch

must be changed from ignition START or ON/RUN to ignition OFF. Carefully check the vehicle for leaks in the underhood compartment and on the ground near the underhood compartment before resetting the system and starting the engine.

After an accident, if the vehicle will not start after performing the reset procedure, the vehicle must be towed to an authorized dealer to be inspected and to have the Enhanced Accident Response System reset.

Enhanced Accident Response System Reset Procedure (EV)

After an event occurs requiring activation of the Enhanced Accident Response System, when the system is active, a "Service Electrical System" message will be displayed on the instrument cluster. The vehicle is not drivable in this state and must be towed to an authorized dealer immediately to be inspected and have the Enhanced Accident Response System reset.

Maintaining Your Air Bag System

WARNING!

- Modifications to any part of the air bag system could cause it to fail when you need it. You could be injured if the air bag system is not there to protect you. Do not modify the components or wiring, including adding any kind of badges or stickers to the steering wheel hub trim cover or the upper passenger side of the instrument panel. Do not modify the front fascia/bumper, vehicle body

(Continued)

WARNING!

structure, or add aftermarket side steps or running boards.

- It is dangerous to try to repair any part of the air bag system yourself. Be sure to tell anyone who works on your vehicle that it has an air bag system.
- Do not attempt to modify any part of your air bag system. The air bag may inflate accidentally or may not function properly if modifications are made. Take your vehicle to an authorized dealer for any air bag system service. If your seat, including your trim cover and cushion, needs to be serviced in any way (including removal or loosening/tightening of seat attachment bolts), take the vehicle to an authorized dealer. Only manufacturer approved seat accessories may be used. If it is necessary to modify the air bag system for persons with disabilities, contact an authorized dealer.

Event Data Recorder (EDR)

This vehicle is equipped with an event data recorder (EDR). The main purpose of an EDR is to record, in certain crash or near crash-like situations, such as an air bag deployment or hitting a road obstacle, data that will assist in understanding how a vehicle's systems performed. The EDR is designed to record data related to vehicle dynamics and safety systems for a short period of time, typically 30 seconds or less. The EDR in this vehicle is designed to record such data as:

- How various systems in your vehicle were operating;

- Whether or not the driver and passenger safety belts were buckled/fastened;
- How far (if at all) the driver was depressing the accelerator and/or brake pedal; and,
- How fast the vehicle was traveling.

These data can help provide a better understanding of the circumstances in which crashes and injuries occur.

NOTE:

EDR data are recorded by your vehicle only if a non-trivial crash situation occurs; no data are recorded by the EDR under normal driving conditions and no personal data (e.g., name, gender, age, and crash location) are recorded. However, other parties, such as law enforcement, could combine the EDR data with the type of personally identifying data routinely acquired during a crash investigation.

To read data recorded by an EDR, special equipment is required, and access to the vehicle or the EDR is needed. In addition to the vehicle manufacturer, other parties, such as law enforcement, that have the special equipment, can read the information if they have access to the vehicle or the EDR.

CHILD RESTRAINTS

Everyone in your vehicle needs to be buckled up at all times, including babies and children. Every state in the United States, and every Canadian province, requires that small children ride in proper restraint systems. This is the law, and you can be prosecuted for ignoring it.

Children 12 years or younger should ride properly buckled up in a rear seat, if available. According

to crash statistics, children are safer when properly restrained in the rear seats rather than in the front.

WARNING!

In a collision, an unrestrained child can become a projectile inside the vehicle. The force required to hold even an infant on your lap could become so great that you could not hold the child, no matter how strong you are. The child and others could be badly injured or killed. Any child riding in your vehicle should be in a proper restraint for the child's size.

There are different sizes and types of restraints for children from newborn size to the child almost large enough for an adult safety belt. Always check the child seat Owner's Manual to make sure you have the correct seat for your child. Carefully read and follow all the instructions and warnings in the child restraint Owner's Manual and on all the labels attached to the child restraint.

Before buying any restraint system, make sure that it has a label certifying that it meets all applicable Safety Standards. You should also make sure that you can install it in the vehicle where you will use it.

NOTE:

- For additional information, refer to <http://www.nhtsa.gov/parents-and-caregivers> or call: 1-888-327-4236
- Canadian residents should refer to Transport Canada's website for additional information: <https://www.tc.gc.ca/en/services/road/child-car-seat-safety.html>

Summary Of Recommendations For Restraining Children In Vehicles

	Child Size, Height, Weight Or Age	Recommended Type Of Child Restraint
Infants and Toddlers	Children who are two years old or younger and who have not reached the height or weight limits of their child restraint	Either an Infant Carrier or a Convertible Child Restraint, facing rearward in a rear seat of the vehicle
Small Children	Children who are at least two years old or who have outgrown the height or weight limit of their rear-facing child restraint	Forward-Facing Child Restraint with a five-point Harness, facing forward in a rear seat of the vehicle
Larger Children	Children who have outgrown their forward-facing child restraint, but are too small to properly fit the vehicle's seat belt	Belt Positioning Booster Seat and the vehicle seat belt, seated in a rear seat of the vehicle
Children Too Large for Child Restraints	Children 12 years old or younger, who have outgrown the height or weight limit of their booster seat	Vehicle Seat Belt, seated in a rear seat of the vehicle

Infant And Child Restraints

Safety experts recommend that children ride rear-facing in the vehicle until they are two years old or until they reach either the height or weight limit of their rear-facing child restraint. Two types of child restraints can be used rear-facing: infant carriers and convertible child seats.

The infant carrier is only used rear-facing in the vehicle. It is recommended for children from birth until they reach the weight or height limit of the infant carrier. Convertible child seats can be used either rear-facing or forward-facing in the vehicle. Convertible child seats often have a higher weight limit in the rear-facing

direction than infant carriers do, so they can be used rear-facing by children who have outgrown their infant carrier but are still less than at least two years old. Children should remain rear-facing until they reach the highest weight or height allowed by their convertible child seat.

WARNING!

- Never place a rear-facing child restraint in front of an air bag. A deploying passenger front air bag can cause death or serious injury to a child 12 years

(Continued)

WARNING!

or younger, including a child in a rear-facing child restraint.

- Never install a rear-facing child restraint in the front seat of a vehicle. Only use a rear-facing child restraint in the rear seat. If the vehicle does not have a rear seat, do not transport a rear-facing child restraint in that vehicle.

WARNING!

Do not install a rear-facing car seat using a rear support leg in this vehicle. The floor of this vehicle is not designed to manage the crash forces of this type of car seat. In a crash, the support leg may not function as it was designed by the car seat manufacturer, and your child may be more severely injured as a result.



SB060100064

Older Children And Child Restraints

Children who are two years old or who have outgrown their rear-facing convertible child seat can ride forward-facing in the vehicle. Forward-facing child seats and convertible child seats used in the forward-facing direction are for children who are over two years old or who have outgrown the rear-facing weight or height limit of their rear-facing convertible child seat. Children should remain in a forward-facing child seat with a harness for as long as possible, up to the highest weight or height allowed by the child seat.

All children whose weight or height is above the forward-facing limit for the child seat should use a belt-

positioning booster seat until the vehicle's seat belts fit properly. If the child cannot sit with knees bent over the vehicle's seat cushion while the child's back is against the seatback, they should use a belt-positioning booster seat. The child and belt-positioning booster seat are held in the vehicle by the seat belt.

WARNING!

- Improper installation can lead to failure of an infant or child restraint. It could come loose in a collision. The child could be badly injured or killed. Follow the child restraint manufacturer's directions exactly when installing an infant or child restraint.
- After a child restraint is installed in the vehicle, do not move the vehicle seat forward or rearward because it can loosen the child restraint attachments. Remove the child restraint before adjusting the vehicle seat position. When the vehicle seat has been adjusted, reinstall the child restraint.
- When your child restraint is not in use, secure it in the vehicle with the seat belt or LATCH anchorages, or remove it from the vehicle. Do not leave it loose in the vehicle. In a sudden stop or accident, it could strike the occupants or seatbacks and cause serious personal injury.

Children Too Large For Booster Seats

Children who are large enough to wear the shoulder belt comfortably, and whose legs are long enough to bend over the front of the seat when their back is

against the seatback, should use the seat belt in a rear seat. Use this simple 5-step test to decide whether the child can use the vehicle's seat belt alone:

1. Can the child sit all the way back against the back of the vehicle seat?
2. Do the child's knees bend comfortably over the front of the vehicle seat while the child is still sitting all the way back?
3. Does the shoulder belt cross the child's shoulder between the neck and arm?
4. Is the lap part of the belt as low as possible, touching the child's thighs and not the stomach?
5. Can the child stay seated like this for the whole trip?

If the answer to any of these questions was "no," then the child still needs to use a booster seat in this vehicle. If the child is using the lap/shoulder belt, check seat belt fit periodically and make sure the seat belt buckle is latched. A child's squirming or slouching can move the belt out of position. If the shoulder belt contacts the face or neck, move the child closer to the center of the vehicle, or use a booster seat to position the seat belt on the child correctly.

WARNING!

Never allow a child to put the shoulder belt under an arm or behind their back. In a crash, the shoulder belt will not protect a child properly, which may result in serious injury or death. A child must always wear both the lap and shoulder portions of the seat belt correctly.

Recommendations For Attaching Child Restraints

Restraint Type	Combined Weight of the Child + Child Restraint	Use Any Attachment Method Shown With An "X" Below			
		LATCH – Lower Anchors Only	Seat Belt Only	LATCH – Lower Anchors + Top Tether Anchor	Seat Belt + Top Tether Anchor
Rear-Facing Child Restraint	Up to 65 lb (29.5 kg)	X	X		
Rear-Facing Child Restraint	More than 65 lb (29.5 kg)		X		
Forward-Facing Child Restraint	Up to 65 lb (29.5 kg)			X	X
Forward-Facing Child Restraint	More than 65 lb (29.5 kg)				X

Lower Anchors And Tethers For Children (LATCH) Restraint System



022668173

LATCH Label



Your vehicle is equipped with the child restraint anchorage system called LATCH, which stands for Lower Anchors and Tethers for Children. The LATCH system has three vehicle anchor points for installing LATCH-equipped child seats. There are two lower anchorages located at the back of the seat cushion where it meets the seatback and one top tether

anchorage located behind the seating position. These anchorages are used to install LATCH-equipped child seats without using the vehicle's seat belts. Some seating positions may have a top tether anchorage but no lower anchorages. In these seating positions, the seat belt must be used with the top tether anchorage to install the child restraint. Please see the following table for more information.

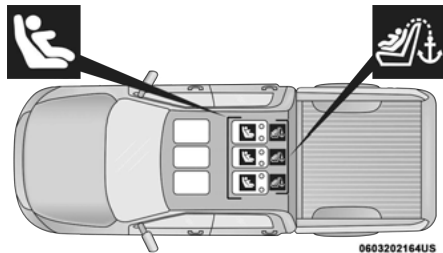
LATCH Positions For Installing Child Restraints In This Vehicle



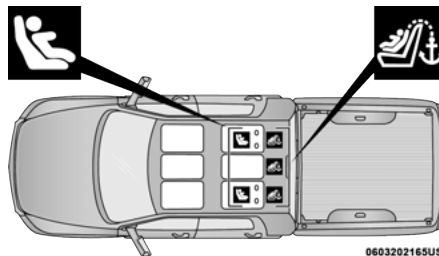

Crew Cab 60/40 Split Bench LATCH Positions

-  Top Tether Anchorage Symbol
-  Lower Anchorage Symbol (2 Anchorges Per Seating Position)



Crew Cab Full Bench, Quad Cab Full Bench And
Quad Cab 60/40 Split Bench LATCH Positions

-  Top Tether Anchorage Symbol
-  Lower Anchorage Symbol (2 Anchorges Per Seating Position)

Frequently Asked Questions About Installing Child Restraints With LATCH

<p>What is the weight limit (child's weight + weight of the child restraint) for using the LATCH anchorage system to attach the child restraint?</p>	<p>65 lb (29.5 kg)</p>	<p>Use the LATCH anchorage system until the combined weight of the child and the child restraint is 65 lb (29.5 kg). Use the seat belt and tether anchor instead of the LATCH system once the combined weight is more than 65 lb (29.5 kg).</p>
<p>Can the LATCH anchorages and the seat belt be used together to attach a rear-facing or forward-facing child restraint?</p>	<p>No</p>	<p>Do not use the seat belt when you use the LATCH anchorage system to attach a rear-facing or forward-facing child restraint.</p> <p>Booster seats may be attached to the LATCH anchorages if allowed by the booster seat manufacturer. See your booster seat owner's manual for more information.</p>

Frequently Asked Questions About Installing Child Restraints With LATCH

Can a child seat be installed in the center position using the inner LATCH lower anchorages from the outboard seating positions?	No	Quad Cab or Crew with Full bench rear seat: Use the seat belt and tether anchor to install a child seat in the center seating position.
Can two child restraints be attached using a common lower LATCH anchorage?	No	Never "share" a LATCH anchorage with two or more child restraints. If the center position does not have dedicated LATCH lower anchorages, use the seat belt to install a child seat in the center position next to a child seat using the LATCH anchorages in an outboard position.
Can the rear-facing child restraint touch the back of the front passenger seat?	Yes	The child seat may touch the back of the front passenger seat if the child restraint manufacturer also allows contact. See your child restraint owner's manual for more information.
Can the rear head restraints be removed?	No	Head restraints may not be removed.

Locating The LATCH Anchorages



The lower anchorages are round bars that are found at the rear of the seat cushion where it meets the seatback, below the anchorage symbols on the seatback. They are just visible when you lean into the rear seat to install the child restraint. You will easily feel them if you run your finger along the gap between the seatback and seat cushion.

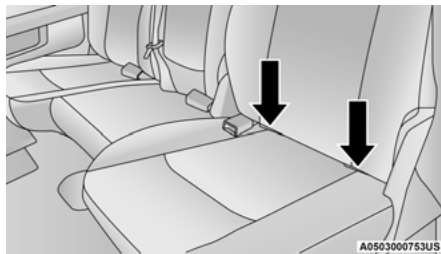

Rear Outboard Seats Driver Side (Example Shown)

Locating The Upper Tether Anchorages



There are tether strap anchorages located behind each of the rear seats.

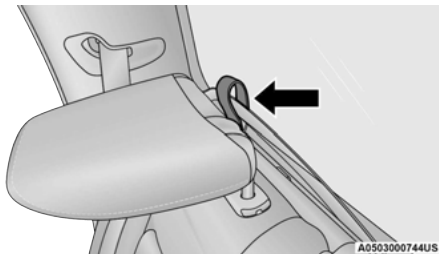

Outboard Tether Anchorage

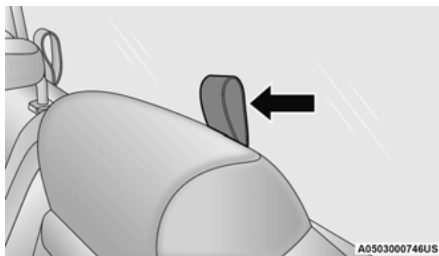

Center Tether Anchorage Over Head Rest

LATCH-compatible child restraint systems will be equipped with a rigid bar or a flexible strap on each side. Each will have a hook or connector to attach to the lower anchorage and a way to tighten the connection to the anchorage. Forward-facing child restraints and some rear-facing child restraints will also be equipped with a tether strap. The tether strap will have a hook at the end to attach to the top tether

anchorage and a way to tighten the strap after it is attached to the anchorage.

Center Seat LATCH

All Quad Cabs Or Crew Cab Full Bench Rear Seat: No Lower Center LATCH Anchorages Available

WARNING!

- Do not install a child restraint in the center position using the LATCH system. This position is not approved for installing child seats using the LATCH attachments. You must use the seat belt and tether anchor to install a child seat in the center seating position.
- Never use the same lower anchorage to attach more than one child restraint → page 323.

Crew Cab Split Bench Rear Seat: Center LATCH Anchorages Available

If a child restraint installed in the center position blocks the seat belt webbing or buckle for the outboard position, do not use that outboard position. If a child seat in the center position blocks the outboard LATCH anchors or seat belt, do not install a child seat in that outboard position.

WARNING!

Never use the same lower anchorage to attach more than one child restraint → page 323.

Always follow the directions of the child restraint manufacturer when installing your child restraint. Not all child restraint systems will be installed as described here.

To Install A LATCH-Compatible Child Restraint

If the selected seating position has a Switchable Automatic Locking Retractor (ALR) seat belt, stow the

seat belt, following the instructions below. See → page 324 to check what type of seat belt each seating position has.

- Loosen the adjusters on the lower straps and on the tether strap of the child seat so that you can more easily attach the hooks or connectors to the vehicle anchorages.
- Place the child seat between the lower anchorages for that seating position. If the second row seat can be reclined, you may recline the seat and/or raise the head restraint (if adjustable) to get a better fit. If the rear seat can be moved forward and rearward in the vehicle, you may wish to move it to its rear-most position to make room for the child seat. You may also move the front seat forward to allow more room for the child seat.
- Attach the lower hooks or connectors of the child restraint to the lower anchorages in the selected seating position.
- If the child restraint has a tether strap, connect it to the top tether anchorage. See → page 326 for directions to attach a tether anchor.
- Tighten all of the straps as you push the child restraint rearward and downward into the seat. Remove slack in the straps according to the child restraint manufacturer's instructions.

6. Test that the child restraint is installed tightly by pulling back and forth on the child seat at the belt path. It should not move more than 1 inch (25.4 mm) in any direction.

How To Stow An Unused Switchable-ALR (ALR) Seat Belt:

When using the LATCH attaching system to install a child restraint, stow all ALR seat belts that are not being used by other occupants or being used to secure child restraints. An unused belt could injure a child if they play with it and accidentally lock the seat belt retractor. Before installing a child restraint using the LATCH system, buckle the seat belt behind the child restraint and out of the child's reach. If the buckled seat belt interferes with the child restraint installation, instead of buckling it behind the child restraint, route the seat belt through the child restraint belt path and then buckle it. Do not lock the seat belt. Remind all children in the vehicle that the seat belts are not toys and that they should not play with them.

WARNING!

- Improper installation of a child restraint to the LATCH anchorages can lead to failure of the restraint. The child could be badly injured or killed. Follow the child restraint manufacturer's

(Continued)

WARNING!

directions exactly when installing an infant or child restraint.

- Child restraint anchorages are designed to withstand only those loads imposed by correctly-fitted child restraints. Under no circumstances are they to be used for adult seat belts, harnesses, or for attaching other items or equipment to the vehicle.

Installing Child Restraints Using The Vehicle Seat Belt

Child restraint systems are designed to be secured in vehicle seats by lap belts or the lap belt portion of a lap/shoulder belt.

WARNING!

- Improper installation or failure to properly secure a child restraint can lead to failure of the restraint. The child could be badly injured or killed.
- Follow the child restraint manufacturer's directions exactly when installing an infant or child restraint.

The seat belts in the passenger seating positions are equipped with a Switchable Automatic Locking Retractor (ALR) that is designed to keep the lap portion

of the seat belt tight around the child restraint so that it is not necessary to use a locking clip. The ALR retractor can be "switched" into a locked mode by pulling all of the webbing out of the retractor and then letting the webbing retract back into the retractor. If it is locked, the ALR will make a clicking noise while the webbing is pulled back into the retractor.

See the "Automatic Locking Mode" description  page 306 for additional information on ALR.

Lap/Shoulder Belt Systems For Installing Child Restraints In This Vehicle

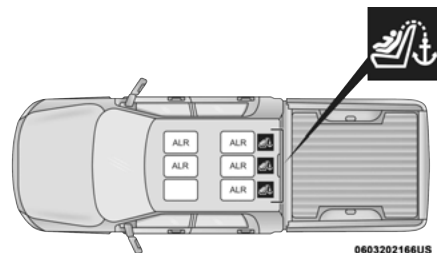

Automatic Locking Retractor — (ALR) Locations (All Models)

ALR — Switchable Automatic Locking Retractor
 Top Tether Anchorage Symbol

Frequently Asked Questions About Installing Child Restraints With Seat Belts		
What is the weight limit (child's weight + weight of the child restraint) for using the Tether Anchor with the seat belt to attach a forward-facing child restraint?	Weight limit of the Child Restraint	Always use the tether anchor when using the seat belt to install a forward-facing child restraint, up to the recommended weight limit of the child restraint.
Can the rear-facing child restraint touch the back of the front passenger seat?	Yes	Contact between the front passenger seat and the child restraint is allowed, if the child restraint manufacturer also allows contact.
Can the rear head restraints be removed?	No	Head restraints may not be removed.
Can the buckle stalk be twisted to tighten the seat belt against the belt path of the child restraint?	No	Do not twist the buckle stalk in a seating position with an ALR retractor.

Installing A Child Restraint With A Switchable Automatic Locking Retractor (ALR):

Child restraint systems are designed to be secured in vehicle seats by lap belts or the lap belt portion of a lap/shoulder belt.

WARNING!

- Improper installation or failure to properly secure a child restraint can lead to failure of the restraint. The child could be badly injured or killed.
- Follow the child restraint manufacturer's directions exactly when installing an infant or child restraint.

1. Place the child seat in the center of the seating position. If the second row seat can be reclined, you may recline the seat and/or raise the head restraint (if adjustable) to get a better fit. If the rear seat can be moved forward and rearward in the vehicle, you may wish to move it to its rear-most position to make room for the child seat. You may also move the front seat forward to allow more room for the child seat.
2. Pull enough of the seat belt webbing from the retractor to pass it through the belt path of the child restraint. Do not twist the belt webbing in the belt path.
3. Slide the latch plate into the buckle until you hear a "click."
4. Pull on the webbing to make the lap portion tight against the child seat.
5. To lock the seat belt, pull down on the shoulder part of the belt until you have pulled all the seat belt webbing out of the retractor. Then, allow the webbing to retract back into the retractor. As the webbing retracts, you will hear a clicking sound. This means the seat belt is now in the Automatic Locking mode.
6. Try to pull the webbing out of the retractor. If it is locked, you should not be able to pull out any webbing. If the retractor is not locked, repeat step 5.
7. Finally, pull up on any excess webbing to tighten the lap portion around the child restraint while you push the child restraint rearward and downward into the vehicle seat.
8. If the child restraint has a top tether strap and the seating position has a top tether anchorage,

connect the tether strap to the anchorage and tighten the tether strap ⇨ page 326.

9. Test that the child restraint is installed tightly by pulling back and forth on the child seat at the belt path. It should not move more than 1 inch (25.4 mm) in any direction.

Any seat belt system will loosen with time, so check the belt occasionally, and pull it tight if necessary.

Installing Child Restraints Using The Top Tether Anchorage

WARNING!

Do not attach a tether strap for a rear-facing car seat to any location in front of the car seat, including the seat frame or a tether anchorage. Only attach the tether strap of a rear-facing car seat to the tether anchorage that is approved for that seating position, located behind the top of the vehicle seat. For the location of approved tether anchorages in your vehicle, see ⇨ page 323.



WARNING!

Never place a rear-facing child restraint in front of an air bag. A deploying passenger front air bag can cause death or serious injury to a child 12 years

(Continued)

WARNING!

or younger, including a child in a rear-facing child restraint.



The top tether anchorages in this vehicle are tether strap loops located between the rear glass and the back of the rear seat.

There is a tether strap loop located behind each seating position. Follow the steps below to attach the tether strap of the child restraint.

Right Or Left Outboard Seats:

1. Reach between the rear seat and rear glass to access the tether strap loop.
2. Place a child restraint on the seat and adjust the tether strap so that it will reach over the seat back, through the space between the head restraint and the seat back, through the tether strap loop behind the seat and over to the tether strap loop behind the center seat.
3. Pass the tether strap hook through the space between the head restraint and the seat back behind the child seat, through the tether strap loop behind the seat and over to the center tether strap loop.

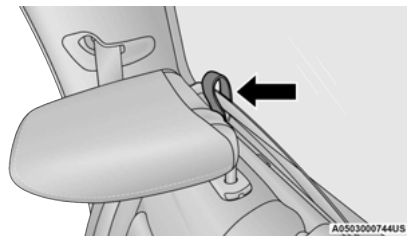

Tether Strap Through Outboard Tether Strap Loop

4. Attach the hook to the center tether strap loop (see diagram). Tighten the tether strap according to the child seat manufacturer's instructions.

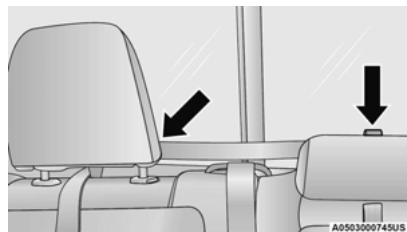

Tether Strap Through Outboard Tether Strap Loop And Attached To Center Tether Strap Loop

NOTE:

If there are child seats in both of the outboard (left and right) seating positions, the tether strap hooks of both child seats should be connected to the center

tether strap loop. This is the correct way to tether two outboard child seats.

Center Seat:

1. Reach between the rear seat and rear glass to access the tether strap loop.

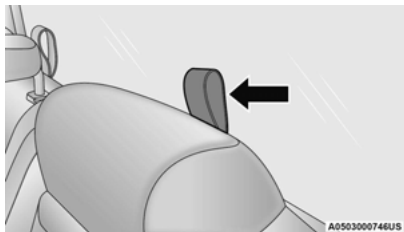

Center Tether Strap Loop Location

2. Place a child restraint on the seat and adjust the tether strap so that it will reach over the seat back and headrest, through the tether strap loop behind the seat and over to the tether strap loop behind either the right or left outboard seat.
3. Pass the tether strap hook over the headrest behind the child seat, through the tether strap loop behind the seat and over to the right or left outboard tether strap loop.

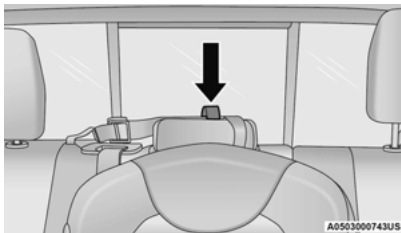

Tether Strap Through Center Tether Strap Loop

4. Attach the hook to the outboard tether strap loop (see diagram). Tighten the tether strap according to the child seat manufacturer's instructions.

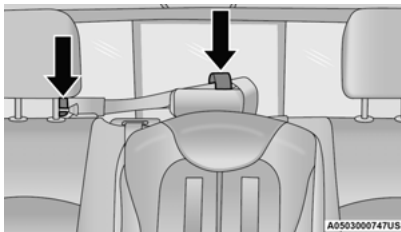

Tether Strap Through Center Tether Strap Loop And Attached To Outboard Tether Strap Loop

Installing Three Child Restraints:

1. Place a child restraint on each outboard rear seat. Route the tether straps following the directions for right and left seating positions, above.

2. Attach both hooks to the center tether strap loop, but do not tighten the straps yet.
3. Place a child restraint on the center rear seat. Route the tether strap following the directions for the center seating position, above.
4. Attach the hook to the outboard tether strap loop.

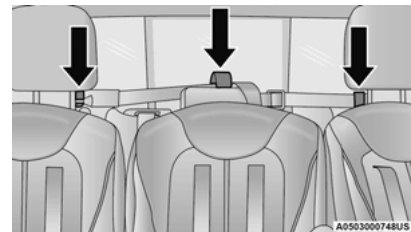

Outboard And Center Seating Positions Shown

5. Tighten the tether straps according to the child seat manufacturer's instructions, tightening the right and left tether straps before the center tether strap.

WARNING!

- An incorrectly anchored tether strap could lead to increased head motion and possible injury to the child. Use only the anchorage position directly behind the child seat to secure a child restraint top tether strap.
- If your vehicle is equipped with a split rear seat, make sure the tether strap does not slip into the

(Continued)

WARNING!

opening between the seatbacks as you remove slack in the strap.

SAFETY TIPS**TRANSPORTING PASSENGERS**

NEVER TRANSPORT PASSENGERS IN THE CARGO AREA.

WARNING!

- Do not leave children or animals inside parked vehicles in hot weather. Interior heat buildup may cause serious injury or death.
- It is extremely dangerous to ride in a cargo area, inside or outside of a vehicle. In a collision, people riding in these areas are more likely to be seriously injured or killed.
- Do not allow people to ride in any area of your vehicle that is not equipped with seats and seat belts.
- Be sure everyone in your vehicle is in a seat and using a seat belt properly.

TRANSPORTING PETS

Air Bags deploying in the front seat could harm your pet. An unrestrained pet will be thrown about and possibly injured, or injure a passenger during panic braking or in a collision.

Pets should be restrained in the rear seat (if equipped) in pet harnesses or pet carriers that are secured by seat belts.

CONNECTED VEHICLES

Privacy of any wireless and wired communications cannot be ensured. Third parties may unlawfully intercept information and private communications without your consent. For further information, refer to “Data Collection & Privacy” in your Uconnect Radio Instruction Manual.

WARNING!

It is not possible to know or to predict all of the possible outcomes if your vehicle's systems are breached. It may be possible that vehicle systems, including safety related systems, could be impaired or a loss of vehicle control could occur that may result in an accident involving serious injury or death.

SAFETY CHECKS YOU SHOULD MAKE INSIDE THE VEHICLE**Seat Belts**

Inspect the seat belt system periodically, checking for cuts, frays, and loose parts. Damaged parts must be replaced immediately. Do not disassemble or modify the system.

If your vehicle is involved in a collision, or if you have questions regarding the seat belt or retractor conditions, take your vehicle to an authorized FCA

dealer or authorized FCA Certified Collision Care Program facility for inspection.

Air Bag Warning Light

The Air Bag Warning Light will turn on for four to eight seconds as a bulb check when the ignition switch is first placed in the ON/RUN position. If the light is either not on during starting, stays on, or turns on while driving, have the system inspected at an authorized dealer as soon as possible. After the bulb check, this light will illuminate with a single chime when a fault with the Air Bag System has been detected. It will stay on until the fault is removed. If the light comes on intermittently or remains on while driving, have an authorized dealer service the vehicle immediately.

See  page 308 for further information.

Defroster



Check operation by selecting the defrost mode and place the blower control on high speed. You should be able to feel the air directed against the windshield. See an authorized dealer for service if your defroster is inoperable.

Floor Mat Safety Information

Always use floor mats designed to fit your vehicle. Only use a floor mat that does not interfere with the operation of the accelerator, brake or clutch pedals. Only use a floor mat that is securely attached using the floor mat fasteners so it cannot slip out of position and interfere with the accelerator, brake or clutch pedals or impair safe operation of your vehicle in other ways.

WARNING!

An improperly attached, damaged, folded, or stacked floor mat, or damaged floor mat fasteners may cause your floor mat to interfere with the accelerator, brake, or clutch pedals and cause a loss of vehicle control. To prevent **SERIOUS INJURY** or **DEATH**:

-  ALWAYS securely attach your floor mat using the floor mat fasteners. **DO NOT** install your floor mat upside down or turn your floor mat over. Lightly pull to confirm mat is secured using the floor mat fasteners on a regular basis.
-  ALWAYS REMOVE THE EXISTING FLOOR MAT FROM THE VEHICLE before installing any other floor mat. **NEVER** install or stack an additional floor mat on top of an existing floor mat.
- **ONLY** install floor mats designed to fit your vehicle. **NEVER** install a floor mat that cannot be properly attached and secured to your vehicle. If a floor mat needs to be replaced, only use a FCA US LLC approved floor mat for the specific make, model, and year of your vehicle.
- **ONLY** use the driver's side floor mat on the driver's side floor area. To check for interference, with the vehicle properly parked with the engine off, fully depress the accelerator, the brake, and the clutch pedal (if present) to check for interference. If your floor mat interferes with the operation of any pedal, or is not secure to the floor, remove the floor mat from the vehicle and place the floor mat in your trunk.

*(Continued)***WARNING!**

- **ONLY** use the passenger's side floor mat on the passenger's side floor area.
- **ALWAYS** make sure objects cannot fall or slide into the driver's side floor area when the vehicle is moving. Objects can become trapped under accelerator, brake, or clutch pedals and could cause a loss of vehicle control.
- **NEVER** place any objects under the floor mat (e.g., towels, keys, etc.). These objects could change the position of the floor mat and may cause interference with the accelerator, brake, or clutch pedals.
- If the vehicle carpet has been removed and re-installed, always properly attach carpet to the floor and check the floor mat fasteners are secure to the vehicle carpet. Fully depress each pedal to check for interference with the accelerator, brake, or clutch pedals then re-install the floor mats.
- It is recommended to only use mild soap and water to clean your floor mats. After cleaning, always check your floor mat has been properly installed and is secured to your vehicle using the floor mat fasteners by lightly pulling mat.

PERIODIC SAFETY CHECKS YOU SHOULD MAKE OUTSIDE THE VEHICLE

Tires

Examine tires for excessive tread wear and uneven wear patterns. Check for stones, nails, glass, or other objects lodged in the tread or sidewall. Inspect the

tread for cuts and cracks. Inspect sidewalls for cuts, cracks, and bulges. Check the lug nut/bolt torque for tightness. Check the tires (including spare) for proper cold inflation pressure.

Lights

Have someone observe the operation of brake lights and exterior lights while you work the controls. Check turn signal and high beam indicator lights on the instrument panel.

Door Latches

Check for proper closing, latching, and locking.

Fluid Leaks

Check area under the vehicle after overnight parking for fuel, coolant, oil, or other fluid leaks. Also, if gasoline fumes are detected or if fuel or brake fluid leaks are suspected, the cause should be located and corrected immediately.

EXHAUST GAS

WARNING!

Exhaust gases can injure or kill. They contain carbon monoxide (CO), which is colorless and odorless. Breathing it can make you unconscious and can eventually poison you. To avoid breathing (CO), follow these safety tips:

(Continued)

WARNING!

- Do not run the engine in a closed garage or in confined areas any longer than needed to move your vehicle in or out of the area.
- If you are required to drive with the trunk/liftgate/rear doors open, make sure that all windows are closed and the climate control BLOWER switch is set at high speed. DO NOT use the recirculation mode.
- If it is necessary to sit in a parked vehicle with the engine running, adjust your heating or cooling controls to force outside air into the vehicle. Set the blower at high speed.

The best protection against carbon monoxide entry into the vehicle body is a properly maintained engine exhaust system.

Whenever a change is noticed in the sound of the exhaust system, when exhaust fumes can be detected inside the vehicle, or when the underside or rear of the vehicle is damaged, have an authorized dealer inspect the complete exhaust system and adjacent body areas for broken, damaged, deteriorated, or mispositioned parts. Open seams or loose connections could permit exhaust fumes to seep into the passenger compartment. In addition, inspect the exhaust system each time the vehicle is raised for lubrication or oil change. Replace as required.

CARBON MONOXIDE WARNINGS**WARNING!**

Carbon monoxide (CO) in exhaust gases is deadly. Follow the precautions provided to prevent carbon monoxide poisoning:

- Do not inhale exhaust gases. They contain carbon monoxide, a colorless and odorless gas, which can kill. Never run the engine in a closed area, such as a garage, and never sit in a parked vehicle with the engine running for an extended period. If the vehicle is stopped in an open area with the engine running for more than a short period, adjust the ventilation system to force fresh, outside air into the vehicle.
- Guard against carbon monoxide with proper maintenance. Have the exhaust system inspected every time the vehicle is raised. Have any abnormal conditions repaired promptly. Until repaired, drive with all side windows fully open.

IN CASE OF EMERGENCY

HAZARD WARNING FLASHERS

The Hazard Warning Flashers button is located on the upper switch bank just below the radio.

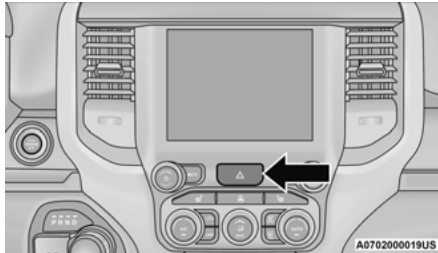

Hazard Warning Flashers Button

NOTE:

If your vehicle is equipped with a 12-inch Uconnect display, the Hazard Warning Flashers button is located above the display.

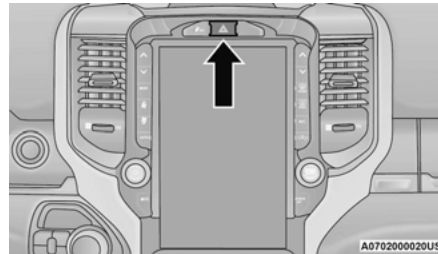

Hazard Warning Flashers Button with 12-inch display

NOTE:

If your vehicle is equipped with a 14.5-inch Uconnect display, the Hazard Warning Flashers button is located to the left of the display.

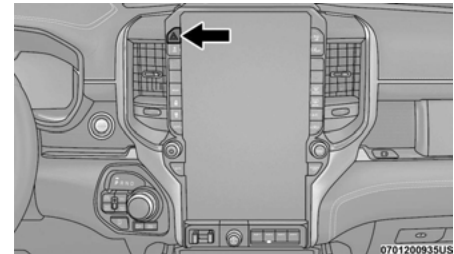

Hazard Warning Flashers Button with 14.5-inch display

Push the button to turn on the Hazard Warning Flashers. When the button is activated, all directional turn signals will flash on and off to warn oncoming traffic of an emergency. Push the button a second time to turn off the Hazard Warning Flashers.

This is an emergency warning system and it should not be used when the vehicle is in motion. Use only when your vehicle is disabled or signaling a safety hazard warning for other motorists.

When leaving the vehicle to seek assistance, the Hazard Warning Flashers will continue to operate even though the vehicle is placed in the OFF position.

NOTE:

With extended use the Hazard Warning Flashers may wear down your battery.

ASSIST AND SOS SYSTEM — IF EQUIPPED

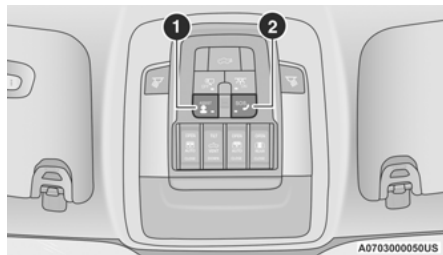

ASSIST And SOS Buttons

- 1 — ASSIST Button
2 — SOS Button

If equipped, the overhead console contains an ASSIST and an SOS button.

WARNING!

ALWAYS obey traffic laws and pay attention to the road. ALWAYS drive safely with your hands on the steering wheel. You have full responsibility and assume all risks related to the use of the features and applications in this vehicle. Only use the features and applications when it is safe to do so. Failure to do so may result in an accident involving serious injury or death.

NOTE:

- Your vehicle may be transmitting data as authorized by the subscriber → page 422.

- The ASSIST and SOS buttons will only function if you are connected to an operable LTE (voice/data) or 4G (data) network, which comes as a built-in function. Other services will only be operable if your RAM Connect service is active and you are connected to an operable 4G (data) network.

ASSIST Call

The ASSIST button is used to automatically connect you to any one of the following support centers:

- Roadside Assistance – If you get a flat tire, or need a tow, just push the ASSIST button, select the Roadside Assistance button to be connected to someone who can help. Roadside Assistance will know what vehicle you're driving and its location. Additional fees may apply for roadside Assistance.
- RAM Connect Customer Care (If available) – In-vehicle support for RAM Connect.
- Vehicle Customer Care – Total support for all other vehicle issues.
- Uconnect Customer Care – Total support for Radio, Phone and NAV issues and Uconnect enrollment if RAM Connect is not supported.

SOS Call

- Push the SOS Call button on the overhead console or in the radio screen.

NOTE:

In case the SOS Call button is pushed in error, there will be a ten second delay before the SOS Call system initiates a call to an SOS operator. To cancel the SOS Call connection, push the SOS Call button on the overhead console or press

the cancellation button on the Device Screen. Termination of the SOS Call will turn off the green LED light on the overhead console.

- The LED lights located within the ASSIST and SOS buttons on the overhead console will turn green once a connection to an SOS operator has been made.
- Once a connection between the vehicle and an SOS operator is made, the SOS Call system may transmit the following important vehicle information to an SOS operator:
 - Indication that the occupant placed an SOS Call
 - The vehicle brand
 - The last known GPS coordinates of the vehicle
- You should be able to speak with the SOS operator through the vehicle audio system to determine if additional help is needed.

WARNING!

ALWAYS obey traffic laws and pay attention to the road. ALWAYS drive safely with your hands on the steering wheel. You have full responsibility and assume all risks related to the use of the features and applications in this vehicle. Only use the features and applications when it is safe to do so. Failure to do so may result in an accident involving serious injury or death.

NOTE:

- Your vehicle may be transmitting data as authorized by the subscriber.

- Once a connection is made between the vehicle's SOS Call system and the SOS operator, the SOS operator may be able to open a voice connection with the vehicle to determine if additional help is needed. Once the SOS operator opens a voice connection with the vehicle's SOS Call system, the operator should be able to speak with you or other vehicle occupants and hear sounds occurring in the vehicle. The vehicle's SOS Call system will attempt to remain connected with the SOS operator until the SOS operator terminates the connection.
5. The SOS operator may attempt to contact appropriate emergency responders and provide them with important vehicle information and GPS coordinates.

WARNING!

- If anyone in the vehicle could be in danger (e.g., fire or smoke is visible, dangerous road conditions or location), do not wait for voice contact from an Emergency Services Agent. All occupants should exit the vehicle immediately and move to a safe location.
- Never place anything on or near the vehicle's operable network and GPS antennas. You could prevent operable network and GPS signal reception, which can prevent your vehicle from placing an emergency call. An operable network and GPS signal reception is required for the SOS Call system to function properly.

*(Continued)***WARNING!**

- The SOS Call system is embedded into the vehicle's electrical system. Do not add aftermarket electrical equipment to the vehicle's electrical system. This may prevent your vehicle from sending a signal to initiate an emergency call. To avoid interference that can cause the SOS Call system to fail, never add aftermarket equipment (e.g., two-way mobile radio, CB radio, data recorder, etc.) to your vehicle's electrical system or modify the antennas on your vehicle. **IF YOUR VEHICLE LOSES BATTERY POWER FOR ANY REASON (INCLUDING DURING OR AFTER AN ACCIDENT), THE UCONNECT FEATURES, APPS AND SERVICES, AMONG OTHERS, WILL NOT OPERATE.**
- Modifications to any part of the SOS Call system could cause the air bag system to fail when you need it. You could be injured if the air bag system is not there to help protect you.

SOS Call System Limitations

Vehicles sold in Mexico **DO NOT** have SOS Call system capabilities.

SOS or other emergency line operators in Mexico may not answer or respond to SOS system calls.

If the SOS Call system detects a malfunction, any of the following may occur at the time the malfunction is detected, and at the beginning of each vehicle cycle:

- The overhead console lights located within the ASSIST and SOS buttons will continuously illuminate red.

- The Device Screen will display, and an audio message will state, the following message: "Vehicle Device Requires Service. Please Contact An Authorized Dealer."

WARNING!

- Ignoring the overhead console light could mean you will not have SOS Call services. If the overhead console light is illuminated and no SOS call placed, have an authorized dealer service the SOS Call system immediately.
- The Occupant Restraint Control module turns on the Air Bag Warning Light on the instrument panel if a malfunction in any part of the system is detected. If the Air Bag Warning Light is illuminated, have an authorized dealer service the Occupant Restraint Control system immediately.

Even if the SOS Call system is fully functional, factors beyond FCA US LLC's control may prevent or stop the SOS Call system operation. These include, but are not limited to, the following factors:

- The vehicle is in the OFF
- The vehicle's electrical systems are not intact
- The SOS Call system software and/or hardware are damaged during a crash
- The vehicle battery loses power or becomes disconnected during a vehicle crash
- LTE (voice/data) or 4G (data) network and/or Global Positioning Satellite signals are unavailable or obstructed
- Equipment malfunction at the SOS operator facility

- Operator error by the SOS operator
- LTE (voice/data) or 4G (data) network congestion
- Weather
- Buildings, structures, geographic terrain, or tunnels

NOTE:

- Your vehicle may be transmitting data as authorized by the subscriber.
- Never place anything on or near the vehicle's LTE (voice/data) or 4G (data) and GPS antennas. You could prevent LTE (voice/data) or 4G (data) and GPS signal reception, which can prevent your vehicle from placing an emergency call. An operable LTE (voice/data) or 4G (data) network connection and a GPS signal is required for the SOS Call system to function properly.

NOTE:

Changes or modifications not expressly approved by the party responsible for compliance could void the user's authority to operate the equipment.

Automatic SOS — If Equipped

Automatic SOS is a hands-free safety service that can immediately connect you with help in the event that your vehicle's air bags deploy. Please refer to your provided radio supplement for complete information.

JACKING AND TIRE CHANGING

Scan this QR code to learn more about Jacking and Tire Changing.

**WARNING!**

- Do not attempt to change a tire on the side of the vehicle close to moving traffic. Pull far enough off the road to avoid the danger of being hit when operating the jack or changing the wheel.
- Being under a jacked-up vehicle is dangerous. The vehicle could slip off the jack and fall on you. You could be crushed. Never put any part of your body under a vehicle that is on a jack. If you need to get under a raised vehicle, take it to a service center where it can be raised on a lift.
- Never start or run the engine while the vehicle is on a jack.
- The jack is designed to be used as a tool for changing tires only. The jack should not be used to lift the vehicle for service purposes. The vehicle should be jacked on a firm level surface only. Avoid ice or slippery areas.

NOTE:

If your vehicle is equipped with an air suspension system, there is a feature which allows the automatic leveling to be disabled to assist with changing a tire. This feature can be activated through the Uconnect system ⇨ page 248.

PREPARATIONS FOR JACKING

NOTE:

If your vehicle is equipped with Air Suspension, you will need to enable Tire Jack Mode in the Uconnect system before changing the tire ⇨ page 157.

1. Park on a firm, level surface. Avoid ice or slippery areas.

WARNING!

Do not attempt to change a tire on the side of the vehicle close to moving traffic. Pull far enough off the road to avoid being hit when operating the jack or changing the wheel.

2. Turn on the Hazard Warning Flashers.
3. Apply the parking brake.
4. Shift the transmission into PARK (P).
5. Turn the ignition OFF.
6. Block both front and rear of the wheel diagonally opposite of the jacking position. For example, if the driver's front wheel is being changed, block the passenger's rear wheel.

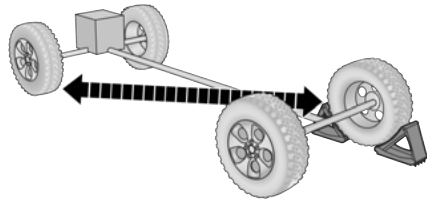

A0707001133US

Wheel Blocked Example

NOTE:

Passengers should not remain in the vehicle when the vehicle is being raised or lifted.

JACK LOCATION

The jack and tools are stored under the front passenger seat.

REMOVAL OF JACK AND TOOLS

To access the jack and tools, you must remove the plastic access cover located on the side of the front passenger's seat. To remove the cover, pull the front part of the cover (closest to the front of the seat) toward you to release a locking tab. Once the front of the cover is loose, slide the cover toward the front of the seat until it is free from the seat frame.



A0707000584US

Pull Jack Access Cover From Front

Remove the jack and tools by turning the wing bolt counterclockwise. After removing the wing bolt, slide the assembly out from under the seat.

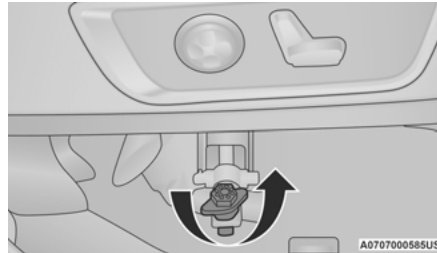

A0707000585US

Jack And Tools

Release the tool bag straps from the jack and remove tools from bag.

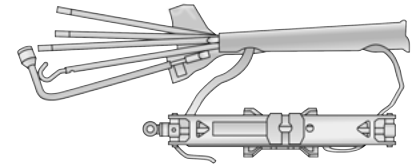

A0707000536US

Jack And Tool Bag

There are two ways to assemble the tools:

Assembled For Spare Tire Lowering/Raising

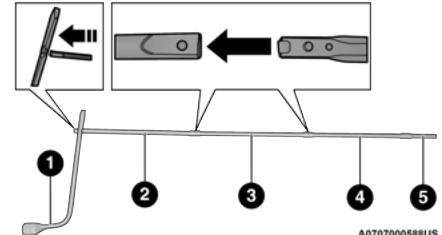

A0707000588US

Assembled For Spare Tire Lowering/Raising

- 1 – Lug Wrench
- 2 – Long Extension Without Spring Clip #2
- 3 – Long Extension With Spring Clip #3
- 4 – Long Extension With Spring Clip #4
- 5 – Short Extension #5

NOTE:

If the tailgate is lowered, adding the shorter extension #5 to jack extension #4 will enable lowering the spare tire without having to raise the tailgate.

CAUTION!

- The lug wrench can only be attached to extension #2.
- When attaching the tool to the winch mechanism be sure the large flared end opening on extension #4 is positioned correctly over the winch mechanism adjusting nut.
- Damage to the lug wrench, extensions and winch mechanism may occur from improper tool assembly.

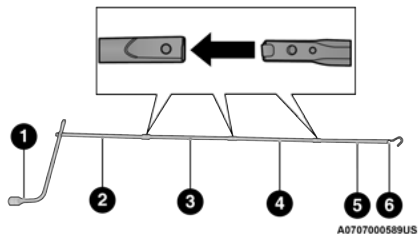
Assembled For Jack Operation**Assembled For Jack Operation**

- 1 – Lug Wrench
- 2 – Long Extension #2
- 3 – Long Extension #3
- 4 – Long Extension #4
- 5 – Short Extension #5
- 6 – Extension With Hook

WARNING!

After using the jack and tools, always reinstall them in the original carrier and location. While driving you may experience abrupt stopping, rapid acceleration or sharp turns. A loose jack, tools, bracket or other objects in the vehicle may move around with force, resulting in serious injury.

REMOVING THE SPARE TIRE

1. Remove the spare tire before attempting to jack up the truck. Attach the lug wrench to the extension tubes with the curved angle facing away from the vehicle.

2. Remove the protective cover over the access hole for the winch mechanism by sliding the cover upward.

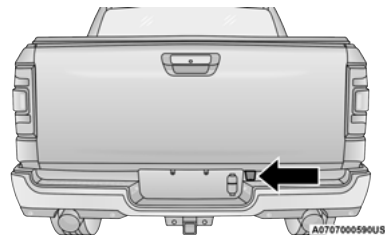
**Access Hole Cover Location**

3. Insert the extension tubes through the access hole between the lower tailgate and the top of the fascia/bumper and into the winch mechanism tube.

CAUTION!

The winch mechanism is designed for use with the jack extension tubes only. Use of an air wrench or other power tools is not recommended and can damage the winch.

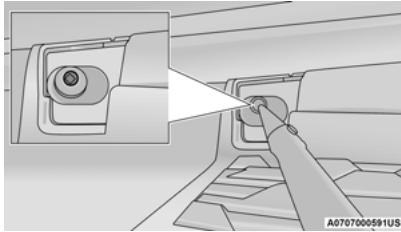

Winch Mechanism Tube

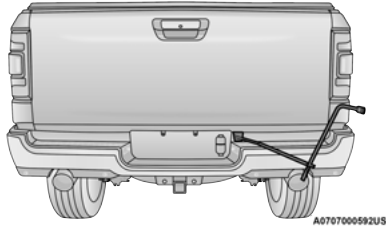
Inserting The Extension
Tubes Into The Access Hole

4. Rotate the lug wrench handle counterclockwise until the spare tire is on the ground with enough cable slack to allow you to pull it out from under the vehicle.

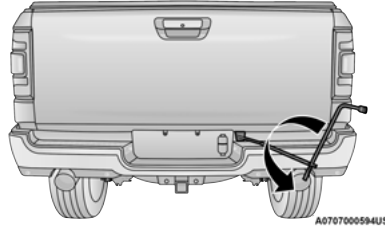

Rotating The Lug Wrench Handle

5. Pull the spare tire out from under the vehicle to gain access to the spare tire retainer.

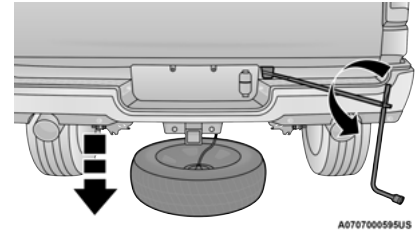

Pulling The Spare Tire Out

6. Lift the spare tire with one hand to give clearance to tilt the retainer at the end of the cable.
7. Pull the retainer through the center of the wheel.

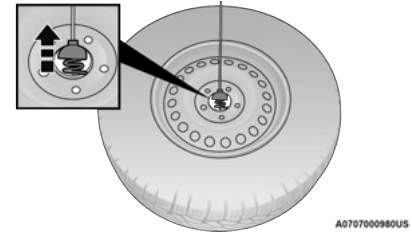

Disengaging The Retainer

JACKING INSTRUCTIONS

WARNING!

Carefully follow these tire changing warnings to help prevent personal injury or damage to your vehicle:

- Always park on a firm, level surface as far from the edge of the roadway as possible before raising the vehicle.
- Turn on the Hazard Warning Flashers.
- Apply the parking brake firmly and set the transmission in PARK.
- Block the wheel diagonally opposite the wheel to be raised.
- Never start or run the engine with the vehicle on a jack.
- Do not let anyone sit in the vehicle when it is on a jack.
- Do not get under the vehicle when it is on a jack. If you need to get under a raised vehicle, take it to a service center where it can be raised on a lift.
- Only use the jack in the positions indicated and for lifting this vehicle during a tire change.
- If working on or near a roadway, be extremely careful of motor traffic.
- To assure that spare tires, flat or inflated, are securely stowed, spares must be stowed with the valve stem facing the ground.



06060714

Jack Warning Label

CAUTION!

Do not attempt to raise the vehicle by jacking on locations other than those indicated in the Jacking Instructions for this vehicle.

1. Remove the spare tire, jack, and tools from the stored location.
2. Using the lug wrench, loosen the wheel nuts (but do not remove), by turning them counterclockwise one turn while the wheel is still on the ground.
3. Assemble the jack and jacking tools. Connect the jack handle driver to the extension, then to the lug wrench.

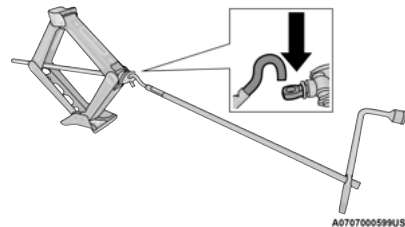

A0797000599US

Assembled Jack And Tools

4. Placement for the front and rear jacking locations are critical. See the following images for proper jacking locations.

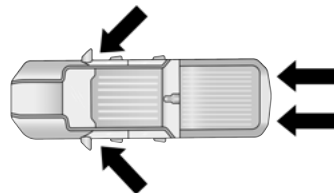

A0797000600US

Jack / Extensions Placement

Front Jacking Location

When changing a front wheel, place the scissor jack under the rear portion of the lower control arm as shown. **Access the front jacking location from behind the front tire.**

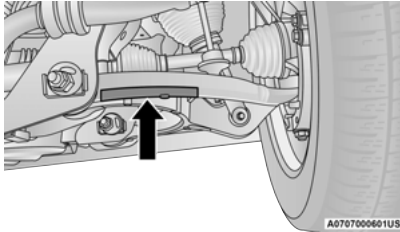

Front Lifting Point

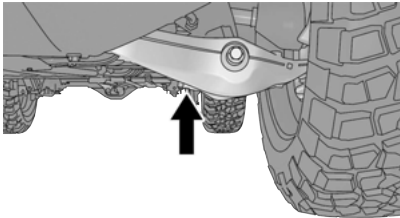

Front Lifting Point — RHO Only

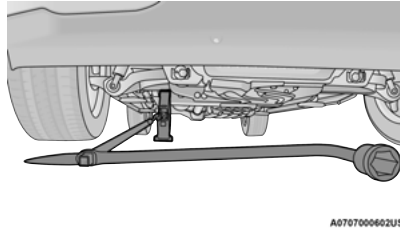

Front Jacking Location

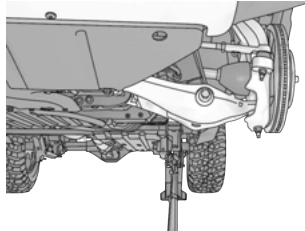

Front Jacking Location — RHO Only

Rear Jacking Location

Operate the jack using the extension with jack hook and the lug wrench. The extension tubes may be used but are not required.

When changing a rear wheel, assemble the extension with jack hook to the jack and connect the extension tubes. **Access the rear jacking location from behind the rear tire.** Place the jack under the Jack Lifting Point located on the rear axle lower control arm bracket. Then locate the slot in the jack lift plate onto the rear axle Jack Lifting Point. Attach the extension with jack hook extending to the rear of the vehicle.

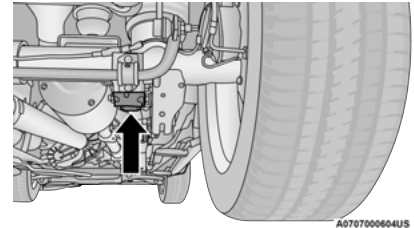

Rear Lifting Point

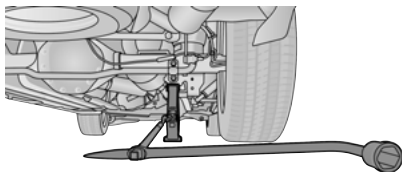

A0707000603U5

Rear Jacking Location

Connect the long extensions to the lug wrench.

CAUTION!

Before raising the wheel off the ground, make sure that the jack will not damage surrounding truck parts and adjust the jack position as required.

- By rotating the lug wrench clockwise, raise the vehicle until the wheel just clears the ground surface.

WARNING!

Raising the vehicle higher than necessary can make the vehicle less stable. It could slip off the jack and hurt someone near it. Raise the vehicle only enough to remove the tire.

- Remove the lug nuts and pull the wheel off. Install the spare wheel and lug nuts with the cone shaped end of the lug nuts toward the wheel. Hand tighten the lug nuts with the vehicle lifted. To avoid the risk of forcing the vehicle off the jack, do not fully tighten the lug nuts until the vehicle has been completely lowered.
- Lower the vehicle to the ground and finish tightening the lug nuts. Push down on the wrench handle for increased leverage. Tighten the lug nuts in a star pattern until each lug nut has been tightened twice → page 411. If in doubt about the correct tightness, have them checked with a torque wrench by an authorized dealer or at a service station.

WARNING!

A loose tire or jack thrown forward in a collision or hard stop, could endanger the occupants of the vehicle. Always stow the jack parts and the spare tire in the places provided.

- If your vehicle is equipped with a wheel center cap, install the cap and remove the wheel blocks. Do not install chrome or aluminum wheel center caps on the spare wheel. This may result in cap damage.

- Lower the jack to its fully closed position. Stow the replaced tire, and secure the jack and tools in the proper location.
- Adjust the tire pressure when possible.

To STOW THE FLAT OR SPARE

- Lift the spare tire with one hand to give clearance to tilt the retainer at the end of the cable.
- Position the wheel behind the rear fascia/bumper facing outward. Push the end of the winch's cable, spring and steel sleeve through the back of the road wheel. Making sure the valve stem is facing the ground when the wheel is stowed.

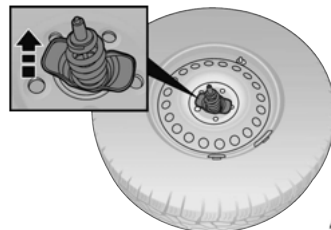

A0707001027U5

Reinstalling The Retainer

- Remove the extension with the hook and reattach the short extension #5 → page 335. Attach the lug wrench to the extension tubes with the curved angle facing away from the vehicle. Insert the extension tubes through the access hole between the lower tailgate and the top of the fascia/bumper and into the winch mechanism tube.

CAUTION!

The winch mechanism is designed for use with the jack extension tubes only. Use of an air wrench or other power tools is not recommended and can damage the winch.

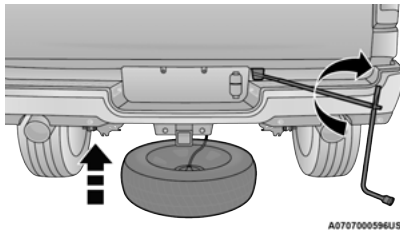
**Reinstalling The Flat Or Spare Tire**

- Rotate the lug wrench handle clockwise until the wheel is drawn into place against the underside of the vehicle. Continue to rotate until you feel the winch mechanism slip, or click three or four times. It cannot be overtightened. Push against the tire several times to ensure it is firmly in place.

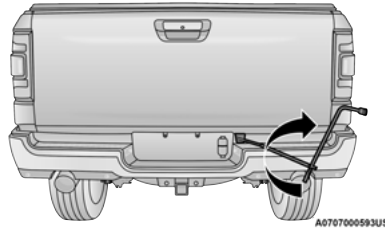
**Rotating The Lug Wrench Handle****NOTE:**

Have the flat tire repaired or replaced immediately.

WARNING!

A loose tire or jack thrown forward in a collision or hard stop could endanger the occupants of the vehicle. Always stow the jack parts and the spare tire in the places provided. Have the deflated (flat) tire repaired or replaced immediately.

REINSTALLING THE JACK AND TOOLS

- Tighten the jack all the way down by turning the jack turn-screw counterclockwise until the jack is snug.
- Position the jack and tool bag. Make sure the lug wrench is under the jack near the jack turn-screw.

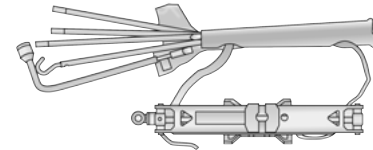
**Jack And Tool Bag**

- Secure the tool bag straps to the jack.

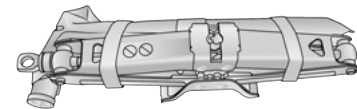
**Jack And Tools Tied**

- Place the jack and tools in the storage position holding the jack by the jack turn-screw, slip the jack and tools under the seat so that the bottom slot engages into the fastener on the floor.

NOTE:

Ensure that the jack slides into the front hold down location.

5. Turn the wing bolt clockwise to secure to the floor pan. Reinstall the plastic cover.



Jack Hold Down Wing Bolt

WARNING!

After using the jack and tools, always reinstall them in the original carrier and location. While driving you may experience abrupt stopping, rapid acceleration or sharp turns. A loose jack, tools, bracket or other objects in the vehicle may move around with force, resulting in serious injury.

JUMP STARTING

If your vehicle has a discharged battery, it can be jump started using a set of jumper cables and a battery in another vehicle, or by using a portable battery booster pack. Jump starting can be dangerous if done improperly, so please follow the procedures in this section carefully.

WARNING!

Do not attempt jump starting if the battery is frozen. It could rupture or explode and cause personal injury.

CAUTION!

Do not use a portable battery booster pack or any other booster source with a system voltage greater than 12 Volts or damage to the battery, starter motor, alternator or electrical system may occur.

NOTE:

When using a portable battery booster pack, follow the manufacturer's operating instructions and precautions.

PREPARATIONS FOR JUMP START

The battery in your vehicle is located in the front of the engine compartment, behind the left headlight assembly.

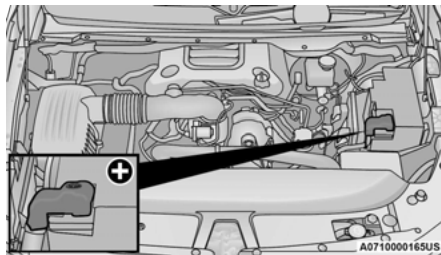

Positive (+) Battery Post Location

NOTE:

The positive battery post may be covered with a protective cap. Lift up on the cap to gain access to the positive battery post. Do not jump off fuses. Only jump directly off positive post which has a positive (+) symbol on or around the post.

See the following steps to prepare for jump starting:

1. Shift the automatic transmission into PARK, apply the parking brake and turn the ignition OFF.
2. Turn off the heater, radio, and all electrical accessories.
3. If using another vehicle to jump start the battery, park the vehicle within the jumper cables' reach, apply the parking brake and make sure the ignition is OFF.

WARNING!

Do not allow vehicles to touch each other as this could establish a ground connection and personal injury could result.

4. Pull upward and remove the protective cover over the positive (+) battery post.

WARNING!

- Take care to avoid the radiator cooling fan whenever the hood is raised. It can start anytime the ignition switch is ON. You can be injured by moving fan blades.

(Continued)

WARNING!

- Remove any metal jewelry such as rings, watch bands and bracelets that could make an inadvertent electrical contact. You could be seriously injured.
- Batteries contain sulfuric acid that can burn your skin or eyes and generate hydrogen gas which is flammable and explosive. Keep open flames or sparks away from the battery.

JUMP STARTING PROCEDURE**WARNING!**

Failure to follow this jump starting procedure could result in personal injury or property damage due to battery explosion.

CAUTION!

Failure to follow these procedures could result in damage to the charging system of the booster vehicle or the discharged vehicle.

Connecting The Jumper Cables

1. Connect the positive (+) end of the jumper cable to the positive (+) post of the discharged vehicle.

NOTE:

Do not jump off fuses. Only jump directly off positive post.

2. Connect the opposite end of the positive (+) jumper cable to the positive (+) post of the booster battery.
3. Connect the negative (-) end of the jumper cable to the negative (-) post of the booster battery.
4. Connect the opposite end of the negative (-) jumper cable to a good engine ground. A "ground" is an exposed metallic/unpainted part of the engine, frame or chassis, such as an accessory bracket or large bolt. The ground must be away from the battery and the fuel injection system.

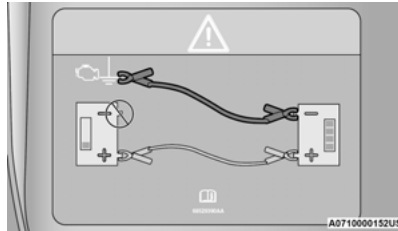
**Jump Starting Label****WARNING!**

Do not connect the jumper cable to the negative (-) post of the discharged battery. The resulting electrical spark could cause the battery to explode and could result in personal injury.

5. Start the engine in the vehicle that has the booster battery, let the engine idle a few minutes, and then start the engine in the vehicle with the discharged battery.

CAUTION!

Do not connect jumper cable to any of the fuses on the positive battery terminal. The resulting electrical current will blow the fuse.

6. Once the engine is started, follow the disconnection procedure.

Disconnecting The Jumper Cables

1. Disconnect the negative (-) end of the jumper cable from the engine ground of the vehicle with the discharged battery.
2. Disconnect the opposite end of the negative (-) jumper cable from the negative (-) post of the booster battery.
3. Disconnect the positive (+) end of the jumper cable from the positive (+) post of the booster battery.
4. Disconnect the opposite end of the positive (+) jumper cable from the positive (+) post of the vehicle with the discharged battery, and reinstall the protective cap.

If frequent jump starting is required to start your vehicle you should have the battery and charging system inspected at an authorized dealer.

CAUTION!

Accessories plugged into the vehicle power outlets draw power from the vehicle's battery, even when not in use (i.e., cellular devices, etc.). Eventually, if plugged in long enough without engine operation, the

(Continued)

CAUTION!

vehicle's battery will discharge sufficiently to degrade battery life and/or prevent the engine from starting.

REFUELING IN EMERGENCY

The vehicle is equipped with a refueling funnel for a capless fuel system. The refueling funnel is located under the passenger's seat along with the jack and tools. If refueling is necessary, while using an approved gas can, insert the refueling funnel into the filler neck opening. Take care to open both flappers with the funnel to avoid spills.

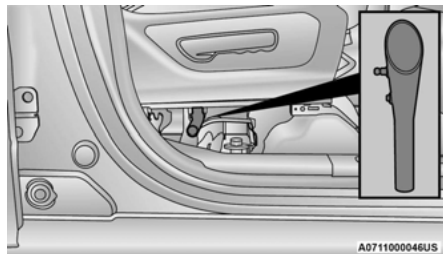

Fuel Funnel Location

NOTE:

In certain cold conditions, ice may prevent the fuel door from opening. If this occurs, lightly push on the fuel door to break the ice buildup and re-release the fuel door using the inside release button. Do not pry on the door.

Emergency Gas Can Refueling:

Most gas cans will not open the flapper doors. A funnel is provided to allow emergency refueling with a gas can.

See the following steps for refueling:

1. Retrieve funnel from under the passenger's front seat.
2. Insert funnel into same filler pipe opening as the fuel nozzle.

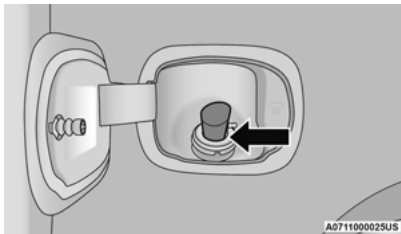
**Inserting Funnel**

3. Ensure funnel is inserted fully to hold flapper doors open.
4. Pour fuel into funnel opening.

CAUTION!

To avoid fuel spillage and overfilling, do not "top off" the fuel tank after filling.

5. Remove funnel from filler pipe, clean off prior to putting back in the spare tire storage area.

WARNING!

- Never have any smoking materials lit in or near the vehicle when the fuel door is open or the tank is being filled.
- Never add fuel when the engine is running. This is in violation of most state and federal fire regulations and may cause the Malfunction Indicator Light to turn on.
- A fire may result if fuel is pumped into a portable container that is inside of a vehicle. You could be burned. Always place fuel containers on the ground while filling.

IF YOUR ENGINE OVERHEATS

If the vehicle is overheating, it will need to be serviced by an authorized dealer.

Potential signs of vehicle overheating:

- Temperature gauge is at HOT (H)
- Strong smell of coolant
- White smoke coming from engine or exhaust
- Coolant bottle coolant has bubbles present

WARNING!

You or others can be badly burned by hot engine coolant (antifreeze) or steam from your radiator. If you see or hear steam coming from under the hood, do not open the hood until the radiator has had time

(Continued)

WARNING!

to cool. Never try to open a cooling system pressure cap when the radiator or coolant bottle is hot.

If the temperature gauge is moving toward or close to the HOT (H) position, you can reduce the potential for overheating by the following:

- On highways — slow down.
- In city traffic — while stopped, place the transmission in NEUTRAL (N), but do not increase the engine idle speed while preventing vehicle motion with the brakes.
- If your Air Conditioner (A/C) is on, turn it off. The A/C system adds heat to the engine cooling system and turning the A/C off can help remove this heat.
- You can also turn the temperature control to maximum heat, the mode control to floor and the blower control to high. This allows the heater core to act as a supplement to the radiator and aids in removing heat from the engine cooling system.

CAUTION!

Driving with a hot cooling system could damage your vehicle. If the temperature gauge reads HOT (H), pull over and stop the vehicle. Idle the vehicle with the air conditioner turned off until the pointer drops back into the normal range. If the pointer remains on HOT (H), and you hear continuous chimes, turn the engine off immediately and call for service.

MANUAL PARK RELEASE**WARNING!**

Always secure your vehicle by fully applying the parking brake before activating the Manual Park Release. In addition, you should be seated in the driver's seat with your foot firmly on the brake pedal when activating the Manual Park Release. Activating the Manual Park Release will allow your vehicle to roll away if it is not secured by the parking brake, or by proper connection to a tow vehicle. Activating the Manual Park Release on an unsecured vehicle could lead to serious injury or death for those in or around the vehicle.

In order to move the vehicle in cases where the transmission will not shift out of PARK (P) (such as a depleted battery), a Manual Park Release is available.

Follow these steps to activate the Manual Park Release:

1. Apply firm pressure to the brake pedal while seated in the driver's seat.
2. Apply the parking brake if possible.
3. Using a small screwdriver or similar tool, open the Manual Park Release cover, which is located to the lower left of the steering column.

**Manual Park Release Access Cover**

4. Behind the Manual Park Release access cover is the orange tether strap. Pull the tether strap out as far as it will go, then release it. The tether and lever will remain outside of the trim panel and the transmission should now be in NEUTRAL, allowing the vehicle to be moved.

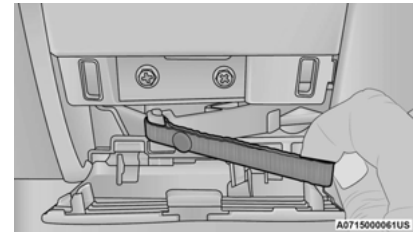
**Manual Park Release Tether****To Reset The Manual Park Release:**

1. Apply firm pressure to the brake pedal while seated in the driver's seat.

- Pull the tether strap out again, then release it.
- Allow the tether to retract with the lever back to its original position.

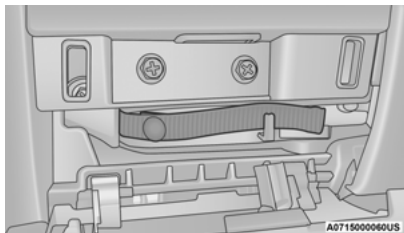

Manual Park Release Tether

- Verify the transmission is in PARK.
- Confirm that the tether has retracted fully and reinstall the access cover. If the access cover cannot be reinstalled, repeat steps 1 through 4.

NOTE:

When the lever is locked in the released position the access cover cannot be reinstalled.

FREEING A STUCK VEHICLE

If your vehicle becomes stuck in mud, sand, or snow, it can often be moved using a rocking motion. Turn the steering wheel right and left to clear the area around the front wheels. Then shift back and forth between DRIVE (D) and REVERSE (R), while gently pressing the accelerator. Use the least amount of accelerator pedal

pressure that will maintain the rocking motion, without spinning the wheels or racing the engine.

CAUTION!

- Racing the engine or spinning the wheels may lead to transmission overheating and failure. Allow the engine to idle with the transmission in NEUTRAL for at least one minute after every five rocking-motion cycles. This will minimize overheating and reduce the risk of transmission failure during prolonged efforts to free a stuck vehicle.
- When "rocking" a stuck vehicle by shifting between DRIVE and REVERSE, do not spin the wheels faster than 15 mph (24 km/h), or drivetrain damage may result.
- Reving the engine or spinning the wheels too fast may lead to transmission overheating and failure. It can also damage the tires. Do not spin the wheels above 30 mph (48 km/h) while in gear (no transmission shifting occurring).

NOTE:

Shifts between DRIVE and REVERSE can only be achieved at wheel speeds of 5 mph (8 km/h) or less. Whenever the transmission remains in NEUTRAL (N) for more than two seconds, you must press the brake pedal to engage DRIVE or REVERSE.

Push the ESC OFF button to place the Electronic Stability Control (ESC) system in "Partial OFF" mode, before rocking the vehicle → page 283. Once the

vehicle has been freed, push the ESC OFF button to restore "ESC On" mode.

WARNING!

Fast spinning tires can be dangerous. Forces generated by excessive wheel speeds may cause damage, or even failure, of the axle and tires. A tire could explode and injure someone. Do not spin your vehicle's wheels faster than 30 mph (48 km/h) or for longer than 30 seconds continuously without stopping when you are stuck and do not let anyone near a spinning wheel, no matter what the speed.

TOWING A DISABLED VEHICLE

This section describes procedures for towing a disabled vehicle using a commercial towing service.

If the transmission and drivetrain are operable, disabled vehicles may also be towed as described on → page 218.

NOTE:

Vehicles equipped with the Active-Level Four Corner Air Suspension System must be placed in Transport mode, before tying them down (from the body) on a trailer or flatbed truck → page 157. If the vehicle cannot be placed in Transport mode (for example, engine will not run), tie-downs must be fastened to the axles (not to the body). Failure to follow these instructions may cause fault codes to be set and/or cause loss of proper tie-down tension.

Towing Condition	Wheels Off The Ground	Two-Wheel Drive Models	Four-Wheel Drive Models
Flat Tow	NONE	NOT ALLOWED	See Instructions <ul style="list-style-type: none"> ● Transmission in PARK ● Transfer case in N (Neutral) ● Tow in forward direction
Dolly Tow	Front	NOT ALLOWED	NOT ALLOWED
	Rear	OK	NOT ALLOWED
On Trailer	ALL	OK	OK

Proper towing or lifting equipment is required to prevent damage to your vehicle. Use only tow bars and other equipment designed for this purpose, following equipment per FCA US LLC instructions. Use of safety chains is mandatory. Attach a tow bar or other towing device to main structural members of the vehicle, not to fascia/bumpers or associated brackets. State and local laws regarding vehicles under tow must be observed.

If you must use the accessories (wipers, defrosters, etc.) while being towed, the ignition must be in the ON/RUN mode, not the ACC mode.

If the key fob is unavailable or the vehicle's battery is discharged, find instructions on shifting the transmission out of PARK in order to move the vehicle  page 345.

CAUTION!

- Do not use sling type equipment when towing. Vehicle damage may occur.
- When securing the vehicle to a flatbed truck, do not attach to front or rear suspension components. Damage to your vehicle may result from improper towing.

TWO-WHEEL DRIVE MODELS

FCA US LLC recommends towing your vehicle with all four wheels **OFF** the ground using a flatbed.

If flatbed equipment is not available, and the transmission is operable, the vehicle may be towed (with front wheels on the ground) under the following conditions:

- The transmission must be in NEUTRAL (N). Instructions on shifting the transmission to NEUTRAL (N) when the engine is **OFF**  page 345.
- The towing speed must not exceed 30 mph (48 km/h).
- The towing distance must not exceed 30 miles (48 km).

If the transmission is not operable, or the vehicle must be towed faster than 30 mph (48 km/h) and farther than 30 miles (48 km), tow with the rear wheels **OFF** the ground. An acceptable method to tow the vehicle on a flatbed are as follows:

- Using a suitable steering wheel stabilizer to hold the front wheels in the straight position with the rear wheels raised and the front wheels **ON** the ground.

CAUTION!

Towing this vehicle in violation of the approved requirements can cause severe transmission damage. Damage from improper towing is not covered under the New Vehicle Limited Warranty.

FOUR-WHEEL DRIVE MODELS

FCA US LLC recommends towing with all wheels **OFF** the ground.

CAUTION!

- Front or rear wheel lifts must not be used (if the remaining wheels are on the ground). Internal damage to the transmission or transfer case will occur if a front or rear wheel lift is used when towing.
- Towing this vehicle in violation of the approved requirements can cause severe transmission and/or transfer case damage. Damage from improper towing is not covered under the New Vehicle Limited Warranty.

EMERGENCY TOW HOOKS — IF EQUIPPED

Your vehicle may be equipped with front and rear emergency tow hooks.

CAUTION!

Tow hooks are for emergency use only, to rescue a vehicle stranded off road. Do not use tow hooks

(Continued)

CAUTION!

for tow truck hookup or highway towing. You could damage your vehicle.

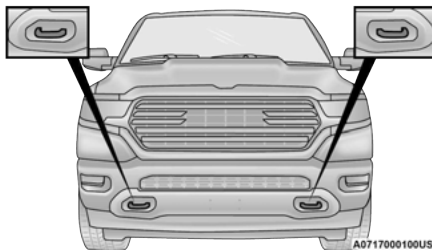

Front Tow Hooks

NOTE:

For off-road recovery, it is recommended to always use both of the tow hooks to minimize the risk of damage to the vehicle.

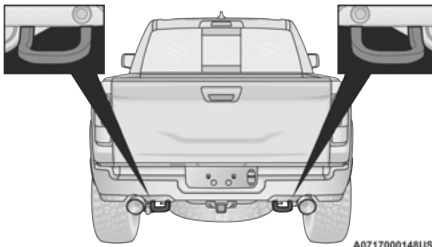

Rear Tow Hooks — RHO Only

WARNING!

- Do not use a chain for freeing a stuck vehicle. Chains may break, causing serious injury or death.
- Stand clear of vehicles when pulling with tow hooks. Tow straps may become disengaged, causing serious injury.

ENHANCED ACCIDENT RESPONSE SYSTEM (EARS)

This vehicle is equipped with an Enhanced Accident Response System.

This feature is a communication network that takes effect in the event of an impact → page 316.

EVENT DATA RECORDER (EDR)

This vehicle is equipped with an Event Data Recorder (EDR). The main purpose of an EDR is to record data that will assist in understanding how a vehicle's systems performed under certain crash or near crash-like situations, such as an air bag deployment or hitting a road obstacle → page 317.

SERVICING AND MAINTENANCE

SCHEDULED SERVICING

Your vehicle is equipped with an automatic oil change indicator system. The oil change indicator system will remind you that it is time to take your vehicle in for scheduled maintenance.

Based on engine operation conditions, the oil change indicator message will illuminate. This means that service is required for your vehicle. Operating conditions such as frequent short-trips, trailer tow, and extremely hot or cold ambient temperatures will influence when the "Oil Change Required" message is displayed. Have your vehicle serviced as soon as possible, within the next 500 miles (805 km).

An authorized dealer will reset the oil change indicator message after completing the scheduled oil change. If a scheduled oil change is performed by someone other

than an authorized dealer, the message can be reset by referring to the steps described under Instrument Cluster Display ⇨ page 116.

NOTE:

Under no circumstances should oil change intervals exceed 10,000 miles (16,000 km), 12 months or 350 hours of engine run time, whichever comes first. The 350 hours of engine run or idle time is generally only a concern for fleet customers.

Once A Month Or Before A Long Trip:

- Check engine oil level
- Check the operation of the interior and exterior lights
- Check the 12V battery terminals, cables and connections

- Check the brake pads, rotors, brake operation and fluid level
- Check the steering, suspension, chassis components and axle boots
- Check the wiper and washer operation, wiper blades and reservoir
- Check the coolant fluid reservoir(s)

MAINTENANCE PLAN

Refer to the Maintenance Plan for required maintenance. More frequent maintenance may be needed in severe conditions, such as dusty areas and very short trip driving. In some extreme conditions, additional maintenance not specified in the maintenance schedule may be required.

At Every Oil Change Interval As Indicated By Oil Change Indicator System

- Change the oil and filter.
- Rotate the tires at the first sign of irregular wear, even if it occurs before the oil indicator system turns on.
- Inspect the battery and clean and tighten terminals as required.
- Inspect the CV/Universal joints.
- Inspect the brake pads, shoes, rotors, drums, and hoses.

Mileage Or Time Passed (Whichever Comes First)	20,000	30,000	40,000	50,000	60,000	70,000	80,000	90,000	100,000	110,000	120,000	130,000	140,000	150,000
Or Years:	2	3	4	5	6	7	8	9	10	11	12	13	14	15
Or Kilometers:	32,000	48,000	64,000	80,000	96,000	112,000	128,000	144,000	160,000	176,000	192,000	208,000	224,000	240,000
Inspect the front and rear axle surfaces. If gear oil leakage is suspected, check the fluid level. If using your vehicle for police, taxi, fleet, off-road or frequent trailer towing, change axle fluid.		X			X			X			X			X
Inspect the brake linings, replace as necessary.	X		X		X		X		X		X		X	
Inspect transfer case fluid.														X
Additional Maintenance														
Replace cabin air filter.	To be replaced every 12,000 miles (19,000 km).													
For severe dusty driving conditions, inspect and replace the Evaporative System Fresh Air Filter as necessary; replacement may be more frequent depending on conditions.	X	X	X	X	X	X	X	X	X	X	X	X	X	X
Replace engine air cleaner filter.		X			X			X			X			X

Mileage Or Time Passed (Whichever Comes First)	20,000	30,000	40,000	50,000	60,000	70,000	80,000	90,000	100,000	110,000	120,000	130,000	140,000	150,000
Or Years:	2	3	4	5	6	7	8	9	10	11	12	13	14	15
Or Kilometers:	32,000	48,000	64,000	80,000	96,000	112,000	128,000	144,000	160,000	176,000	192,000	208,000	224,000	240,000
If equipped with Stop/Start, replace accessory drive belt with OEM grade Mopar® belt.														X
Replace spark plugs. ¹									X					
Flush and replace the engine coolant at 10 years or 150,000 miles (240,000 km) whichever comes first.									X					X
Inspect the transfer case fluid, change for any of the following: police, taxi, fleet, or frequent trailer towing.					X						X			
Change the transfer case fluid.											X			
Inspect and replace PCV valve if necessary.									X					

¹ The spark plug change interval is mileage-based only; yearly intervals do not apply.

WARNING!

- You can be badly injured working on or around a motor vehicle. Do only service work for which you have the knowledge and the right equipment. If you have any doubt about your ability to perform a service job, take your vehicle to a competent mechanic.
- Failure to properly inspect and maintain your vehicle could result in a component malfunction and affect vehicle handling and performance. This could cause an accident.

SCHEDULED SERVICING — RHO

The Scheduled Maintenance services listed in this manual must be done at the times or mileages specified to protect the vehicle warranty and ensure the best vehicle performance and reliability. More frequent maintenance may be needed for vehicles in severe operating conditions, such as dusty areas and very short trip driving. Inspection and service should also be done anytime a malfunction is suspected.

The oil change indicator system will remind you that it is time to take your vehicle in for scheduled maintenance.

The instrument cluster display will display an "Oil Change Required" message and a single chime will sound, indicating that an oil change is necessary.

Based on engine operation conditions, the oil change indicator message will illuminate. This means that service is required for your vehicle. Have your vehicle

serviced as soon as possible, within the next 500 miles (805 km).

NOTE:

- The oil change indicator message will not monitor the time since the last oil change. Change your vehicle's oil if it has been six months since your last oil change, even if the oil change indicator message is NOT illuminated.
- Change your engine oil more often if you drive your vehicle off-road for an extended period of time.
- Under no circumstances should oil change intervals exceed 6,000 miles (10,000 km) or six months, whichever comes first.

An authorized dealer will reset the oil change indicator message after completing the scheduled oil change. If a scheduled oil change is performed by someone other than an authorized dealer, the message can be reset by referring to the steps described under Instrument Cluster Display ➔ page 116.

Severe Duty All Models

Vehicles that are operated in a dusty and off-road environment, or predominately at idle or very low engine RPM are known as Severe Duty vehicles. It is recommended that you change engine oil at 4,000 miles (6,500 km) or 350 hours of engine run time.

At Each Stop For Fuel

- Check the engine oil level.
- Check the windshield washer solvent and add if required.

Once A Month

- Check engine oil level
- Check the operation of the interior and exterior lights
- Check the 12V battery terminals, cables and connections
- Check the brake pads, rotors, brake operation and fluid level
- Check the steering, suspension, chassis components and axle boots
- Check the wiper and washer operation, wiper blades and reservoir
- Check the coolant fluid reservoir(s)

At Each Oil Change

- Change the engine oil filter.
- Deploy power side steps and clean linkages with high pressure car wash wand to remove any foreign debris. Apply MOPAR Spray White Lithium Grease to the pivot points.
- Inspect the brake hoses and lines.
- Inspect the CV/Universal joints.

CAUTION!

Failure to perform the required maintenance items may result in damage to the vehicle.

MAINTENANCE PLAN

	Miles:	6,000	12,000	18,000	24,000	30,000	36,000	42,000	48,000	54,000	60,000	66,000	72,000	78,000	84,000	90,000	96,000	102,000	108,000	114,000	120,000	126,000	132,000	138,000	144,000	150,000	
	Or Months:	6	12	18	24	30	36	42	48	54	60	66	72	78	84	90	96	102	108	114	120	126	132	138	144	150	
	Or Kilometers:	10,000	20,000	30,000	40,000	50,000	60,000	70,000	80,000	90,000	100,000	110,000	120,000	130,000	140,000	150,000	160,000	170,000	180,000	190,000	200,000	210,000	220,000	230,000	240,000	250,000	
Change the engine oil and engine oil filter.	X	X	X	X	X	X	X	X	X	X	X	X	X	X	X	X	X	X	X	X	X	X	X	X	X	X	X
Rotate the tires, rotate at the first sign of irregular wear, even if it occurs before scheduled maintenance.	X	X	X	X	X	X	X	X	X	X	X	X	X	X	X	X	X	X	X	X	X	X	X	X	X	X	X
If using your vehicle for any of the following: dusty or off-road conditions. Inspect the engine air cleaner filters; replace if necessary.		X		X		X		X		X		X		X		X		X		X		X		X		X	
Inspect the brake linings; replace if necessary.		X		X		X		X		X		X		X		X		X		X		X		X		X	
Inspect the CV/Universal joints.	X	X	X	X	X	X	X	X	X	X	X	X	X	X	X	X	X	X	X	X	X	X	X	X	X	X	X
Inspect the exhaust system.		X		X		X		X		X		X		X		X		X		X		X		X		X	
Adjust the parking brake on vehicles equipped with four wheel disc brakes.						X					X					X					X						X

	Miles:	6,000	12,000	18,000	24,000	30,000	36,000	42,000	48,000	54,000	60,000	66,000	72,000	78,000	84,000	90,000	96,000	102,000	108,000	114,000	120,000	126,000	132,000	138,000	144,000	150,000		
	Or Months:	6	12	18	24	30	36	42	48	54	60	66	72	78	84	90	96	102	108	114	120	126	132	138	144	150		
	Or Kilometers:	10,000	20,000	30,000	40,000	50,000	60,000	70,000	80,000	90,000	100,000	110,000	120,000	130,000	140,000	150,000	160,000	170,000	180,000	190,000	200,000	210,000	220,000	230,000	240,000	250,000		
Drain the transfer case and refill.						X					X					X					X					X		
Inspect the accessory drive belts replace if necessary.											X										X							
Inspect the front and rear axle fluid. Change if using your vehicle for any of the following: police, taxi, fleet, sustained high speed driving, off-road or frequent trailer towing.					X				X				X				X				X					X		
Inspect front suspension, tie rod ends, and boot seals, for cracks or leaks and all parts for damage, wear, improper looseness or end play; replace if necessary.		X		X			X				X			X			X				X			X			X	
Replace the engine air cleaner filters.						X					X					X					X						X	
Replace the cabin air filter.		To be replaced every 12,000 miles (19,000 km).																										
Inspect and replace the PCV Valve if necessary.																X												

Miles:	6,000	12,000	18,000	24,000	30,000	36,000	42,000	48,000	54,000	60,000	66,000	72,000	78,000	84,000	90,000	96,000	102,000	108,000	114,000	120,000	126,000	132,000	138,000	144,000	150,000	
Or Months:	6	12	18	24	30	36	42	48	54	60	66	72	78	84	90	96	102	108	114	120	126	132	138	144	150	
Or Kilometers:	10,000	20,000	30,000	40,000	50,000	60,000	70,000	80,000	90,000	100,000	110,000	120,000	130,000	140,000	150,000	160,000	170,000	180,000	190,000	200,000	210,000	220,000	230,000	240,000	250,000	
Replace the spark plugs – 3.0L Engine. ²										X										X						
Flush and replace the engine coolant at 120 months if not done at 150,000 miles (240,000 km).																					X					X

WARNING!

- You can be badly injured working on or around a motor vehicle. Do only service work for which you have the knowledge and the right equipment. If you have any doubt about your ability to perform a service job, take your vehicle to a competent mechanic.
- Failure to properly inspect and maintain your vehicle could result in a component malfunction and effect vehicle handling and performance. This could cause an accident.

² The spark plug change interval is mileage based only, monthly intervals do not apply.

ENGINE COMPARTMENT

3.0L ENGINE — STANDARD OUTPUT

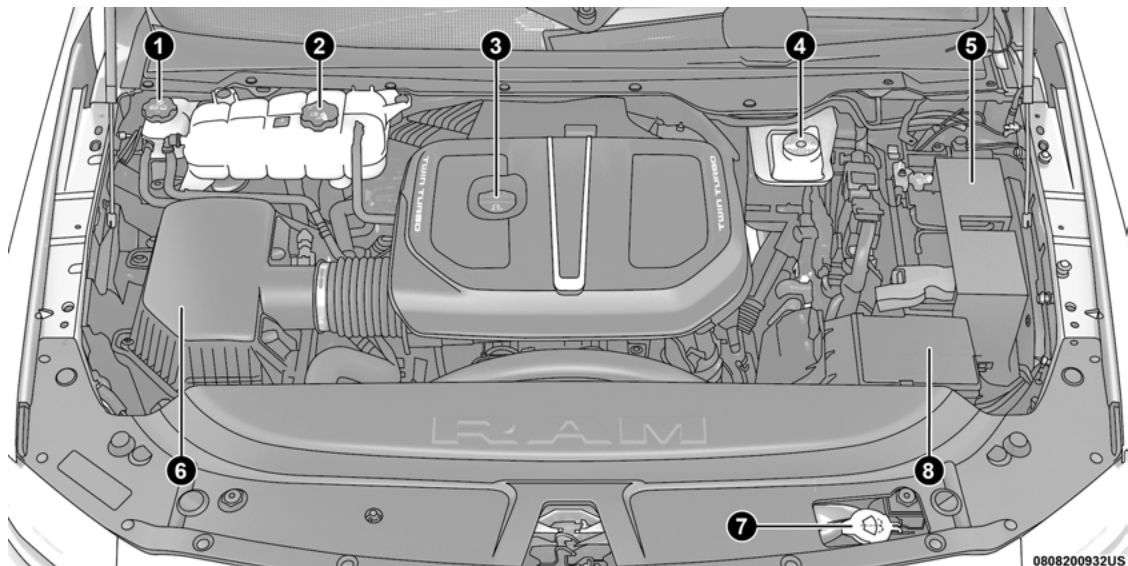

3.0 Liter Engine Standard Output

- 1 — Intercooler Coolant Pressure Cap
- 2 — Engine Coolant Pressure Cap
- 3 — Engine Oil Fill Cap
- 4 — Brake Fluid Reservoir Cap

- 5 — Battery
- 6 — Engine Air Cleaner, Filter
- 7 — Washer Fluid Reservoir Cap
- 8 — Power Distribution Center (Fuses)

3.0L ENGINE — HIGH OUTPUT

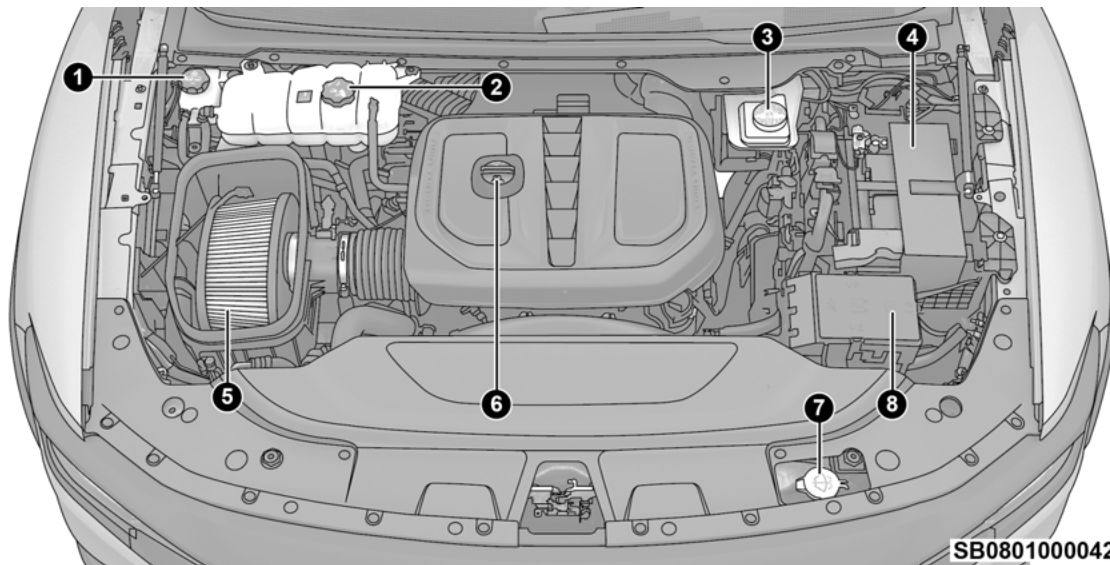

SB080100042

3.0 Liter Engine High Output

- 1 — Intercooler Coolant Pressure Cap
- 2 — Engine Coolant Pressure Cap
- 3 — Brake Fluid Reservoir Cap
- 4 — Battery

- 5 — Engine Air Cleaner, Filter
- 6 — Engine Oil Fill Cap
- 7 — Washer Fluid Reservoir Cap
- 8 — Power Distribution Center (Fuses)

3.6L ENGINE WITH STOP/START

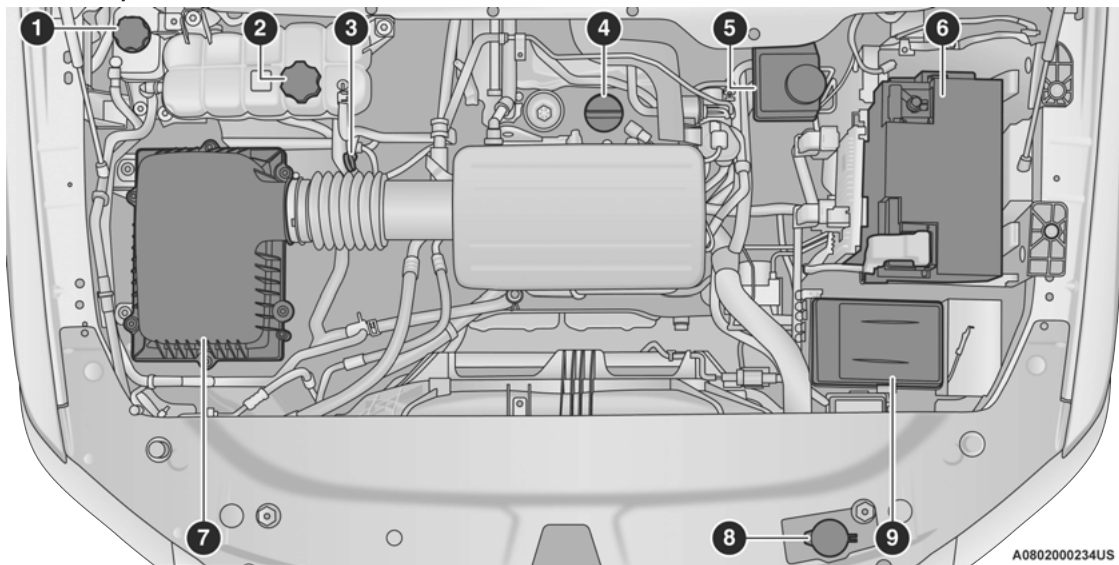

A0802000234US

3.6L Engine With Stop/Start

- 1 – Motor Generator Unit Coolant Reservoir Pressure Cap
- 2 – Engine Coolant Reservoir Pressure Cap
- 3 – Engine Oil Dipstick
- 4 – Engine Oil Fill
- 5 – Brake Fluid Reservoir



- 6 – Battery
- 7 – Engine Air Cleaner, Filter
- 8 – Washer Fluid Reservoir Cap
- 9 – Power Distribution Center (Fuses)

CHECKING OIL LEVEL — 3.0L ENGINES

The 3.0L engine does not have a traditional “dipstick” and there is no need to manually check the oil level. If it is desired to check engine oil level, it can be seen on the instrument cluster display by navigating to the appropriate screen under “Vehicle Info”. Use the **up** \blacktriangle or **down** \blacktriangledown arrow buttons within the steering wheel controls to find the “Vehicle Info” menu. Then use the **right** \blacktriangleright or **left** \blacktriangleleft arrow buttons until you reach the “Oil Level” submenu.

There is a bar on the gauge which shows the oil level. As long as the oil level is between the minimum and the maximum it is safe to operate the vehicle. If the oil level is either too high or too low, a red bar will be illuminated.

When the engine is in need of more oil, the Oil Level Warning Light will illuminate. This warning will appear for five seconds. Within the next 300 miles (500 km) you should add 1 quart of manufacturer specified motor oil to the engine \rightarrow page 415.

Oil Level Critically Low (Add 2 Quarts)	
Oil Level Low (Add 1 Quart)	
Oil Level Ok	

Oil Level Critically High	
---------------------------	---

This light will reappear every time the engine is started until a safe level is detected. Continuing to operate the vehicle without adding oil may result in a critically low oil level and possible engine damage (see the following Caution regarding Critically Low).

NOTE:

Use care when filling under hood fluids such as engine oil, washer fluid, antifreeze, etc. to minimize spillage onto top of engine. Any excess fluid that is spilled onto the top of the engine should be removed using compressed air or an absorbent cloth.

Oil Level Display - How To Refresh

The oil level is automatically monitored when the vehicle is parked on a level surface, the oil is warm and the engine has been off approximately four minutes. To refresh the oil level display (after a quart of the correct oil has been added), follow this process:

- Run the engine until the oil temperature is above 180 °F (82 °C).
- Park the vehicle on relatively level ground.
- Turn the engine off and cycle the Start button to the ON/RUN position. Wait four minutes with the engine off, and the button in the ON/RUN position.
- Start the engine and the new oil level will be available in the Vehicle Info menu (accessible via the navigation buttons on the steering wheel).

NOTE:

- If there has not been a notable change in the oil level since the previous reading, there may not be any notification or change in the display after the system has taken another reading.
- The oil level system takes measurements only while the engine is off, has warm oil, and the vehicle is parked on reasonably level ground. In order to get a consistent oil level reading the Start button must be in the ON/RUN position for approximately four minutes, however the system may occasionally take readings with the vehicle OFF during normal usage.
- If you have added a quart of oil and the indicator is not reading 3/4 or full, please contact an authorized dealer for service.

WARNING!
Be aware the oil cap may be hot. Please use suitable gloves. WARNING: risk of burns!
CAUTION!
Do not to add too much oil. Overfilling the oil may damage the engine.

NOTE:

- After adding oil to the engine, always reinstall the oil cap securely by rotating clockwise until it stops. Never run the engine without the oil fill cap as this could cause an oil leak.
- Because the oil level is automatically detected only when the engine has been off and restarted (after four minutes), the system cannot immediately detect a sudden drop in oil level while driving (for example,

if the oil pan starts to leak due to damage during an off-road event).

CAUTION!

If the “Critically Low or Critically High” Oil Level Warning Light is illuminated, the following steps should be taken:

- Critically Low: add two quarts of manufacturer specified oil as soon as possible ➡ page 415. Continuing to operate the vehicle with “Critically Low” oil level may damage the engine.
- Critically High: contact an authorized dealer for service. Continuing to operate the vehicle with “Critically High” oil level may damage the engine.

Do not use any oils that are not manufacturer specified and API approved.

Used engine oil and oil filters contain substances which are harmful to the environment. When oil and filters are changed contact an authorized dealer and dispose of in a safe and responsible manner.

CHECKING OIL LEVEL — 3.6L ENGINE

To ensure proper engine lubrication, the engine oil must be maintained at the correct level. Check the oil level at regular intervals, such as every fuel stop. The best time to check the engine oil level is about five minutes after a fully warmed up engine is shut off.

Checking the oil while the vehicle is on level ground will improve the accuracy of the oil level readings.

There are four possible dipstick types:

- Crosshatched zone.
- Crosshatched zone marked SAFE.
- Crosshatched zone marked with MIN at the low end of the range and MAX at the high end of the range.
- Crosshatched zone marked with dimples at the MIN and the MAX ends of the range.

NOTE:

Always maintain the oil level within the crosshatch markings on the dipstick.

Adding 1 qt (1.0 L) of oil when the reading is at the low end of the dipstick range will raise the oil level to the high end of the range marking.

CAUTION!

Overfilling or underfilling the crankcase will cause oil aeration or loss of oil pressure. This could damage your engine.

ADDING WASHER FLUID

The fluid reservoir is located under the hood and the fluid level should be checked at regular intervals. Fill the reservoir with windshield washer solvent only (not radiator antifreeze). When refilling the washer fluid reservoir, take some washer fluid and apply it to a cloth or towel and wipe the wiper blades clean. This will help blade performance.

To prevent freeze-up of your windshield washer system in cold weather, select a solution or mixture that meets or exceeds the temperature range of your climate. This rating information can be found on most washer fluid containers.

WARNING!

Commercially available windshield washer solvents are flammable. They could ignite and burn you. Care must be exercised when filling or working around the washer solution.

After the engine has warmed up, operate the defroster for a few minutes to reduce the possibility of smearing or freezing the fluid on the cold windshield. Windshield washer solution used with water as directed on the container, aids cleaning action, reduces the freezing point to avoid line clogging, and is not harmful to paint or trim.

MAINTENANCE-FREE 12 VOLT BATTERY

Your vehicle is equipped with a maintenance-free battery. You will never have to add water, and periodic maintenance is not required.

WARNING!

- Battery fluid is a corrosive acid solution and can burn or even blind you. Do not allow battery fluid to contact your eyes, skin, or clothing. Do not lean over a battery when attaching clamps. If acid splashes in eyes or on skin, flush the area immediately with large amounts of water.
- Battery gas is flammable and explosive. Keep flame or sparks away from the battery. Do not use a booster battery or any other booster source with an output greater than 12 Volts. Do not allow cable clamps to touch each other.

(Continued)

WARNING!

- Battery posts, terminals, and related accessories contain lead and lead compounds. Wash hands after handling.

CAUTION!

- It is essential when replacing the cables on the battery that the positive cable is attached to the positive post and the negative cable is attached to the negative post. Battery posts are marked positive (+) and negative (-) and are identified on the battery case. Cable clamps should be tight on the terminal posts and free of corrosion.
- If a "fast charger" is used while the battery is in the vehicle, disconnect both vehicle battery cables before connecting the charger to the battery. Do not use a "fast charger" to provide starting voltage.

PRESSURE WASHING

Cleaning the underhood compartment with a high pressure washer is not recommended.

CAUTION!

Precautions have been taken to safeguard all parts and connections however, the pressures generated by these machines is such that complete protection against water ingress cannot be guaranteed.

VEHICLE MAINTENANCE

An authorized dealer has the qualified service personnel, special tools, and equipment to perform all service operations in an expert manner. Service Manuals are available which include detailed service information for your vehicle. Refer to these Service Manuals before attempting any procedure yourself.

NOTE:

Intentional tampering with emissions control systems may void your warranty and could result in civil penalties being assessed against you.

WARNING!

You can be badly injured working on or around a motor vehicle. Only do service work for which you have the knowledge and the proper equipment. If you have any doubt about your ability to perform a service job, take your vehicle to a competent mechanic.

ENGINE OIL**Engine Oil Selection**

Use only the manufacturer's recommended fluids  page 415.

NOTE:

Engines at times can tick right after startup and then quiet down after approximately 30 seconds. This is normal and will not harm the engine. This characteristic can be caused by short drive cycles. For example, if the vehicle is started then shut off after driving a short distance. Upon restarting, you may experience a ticking

sound. Other causes could be if the vehicle is unused for an extended period of time, incorrect oil, extended oil changes or extended idling. If the engine continues to tick or if the Malfunction Indicator Light (MIL) comes on, see the nearest authorized dealer.

American Petroleum Institute (API) Approved Engine Oil

These symbols mean that the oil has been certified by the API. The manufacturer only recommends API trademark oils.



The API Starburst trademark certifies 0W-20, 0W-30 and 5W-30 engine oils.



The API Donut trademark certifies 0W-40 and 5W-40 engine oil.

CAUTION!

Do not use chemical flushes in your engine oil as the chemicals can damage your engine. Such damage is not covered by the New Vehicle Limited Warranty.

Synthetic Engine Oils

Your engine was designed for synthetic engine oils, only use synthetic API approved engine oils.

Synthetic engine oils which do not have both the correct API trademark and the correct SAE viscosity grade numbers should not be used.

Materials Added To Engine Oil

The manufacturer strongly recommends against the addition of any additives (other than leak detection dyes) to the engine oil. Engine oil is an engineered product and its performance may be impaired by supplemental additives.

Disposing Of Used Engine Oil And Oil Filters

Care should be taken in disposing of used engine oil and oil filters from your vehicle. Used oil and oil filters, indiscriminately discarded, can present a problem to the environment. Contact an authorized dealer, service station or governmental agency for advice on how and where used oil and oil filters can be safely discarded in your area.

ENGINE OIL FILTER

The engine oil filter should be replaced with a new filter at every engine oil change.

Engine Oil Filter Selection

A full-flow type disposable oil filter should be used for replacement. The quality of replacement filters varies considerably. Only high quality Mopar® certified filters should be used. If Mopar® Engine Oil Filters are unavailable, only use filters that meet or exceed SAE/USCAR-36 Filter Performance Requirements.

ENGINE AIR CLEANER FILTER

For the proper maintenance intervals → page 349.

WARNING!

The air induction system (air cleaner, hoses, etc.) can provide a measure of protection in the case of engine backfire. Do not remove the air induction system (air cleaner, hoses, etc.) unless such removal is necessary for repair or maintenance. Make sure that no one is near the engine compartment before starting the vehicle with the air induction system (air cleaner, hoses, etc.) removed. Failure to do so can result in serious personal injury.

Engine Air Cleaner Filter Selection

The quality of replacement filters varies considerably. Only high quality Mopar® certified filters should be used.

Engine Air Cleaner, Filter Inspection And Replacement

Engine Air Cleaner Filter Removal

1. With suitable tool fully loosen (six) fasteners on the engine air cleaner filter cover.
2. Lift the engine air cleaner filter cover to access the engine air cleaner filter.
3. Remove the engine air cleaner filter from the housing assembly.

Engine Air Cleaner Filter Installation

NOTE:

Inspect and clean the housing if dirt or debris is present before replacing the engine air cleaner filter.

1. Install the engine air cleaner filter into the housing with the filter pleated material facing down, and the seal on the top.
2. Install the engine air cleaner filter cover onto the housing assembly.
3. Tighten the fasteners (six) on the engine air cleaner filter assembly.

AIR CONDITIONER MAINTENANCE

For best possible performance, your air conditioner should be checked and serviced by an authorized dealer at the start of each warm season. This service should include cleaning of the condenser fins and a performance test. Drive belt tension should also be checked at this time.

WARNING!

- Use only refrigerants and compressor lubricants approved by the manufacturer for your air conditioning system. Some unapproved refrigerants are flammable and can explode, injuring you. Other unapproved refrigerants or lubricants can cause the system to fail, requiring costly repairs. Refer to Warranty Information Book, for further warranty information.
- The air conditioning system contains refrigerant under high pressure. To avoid risk of personal injury or damage to the system, adding refrigerant or any repair requiring lines to be disconnected should be done by an experienced technician.

CAUTION!

Do not use chemical flushes in your air conditioning system as the chemicals can damage your air conditioning components. Such damage is not covered by the New Vehicle Limited Warranty.

Refrigerant Recovery And Recycling – R-1234yf

R-1234yf Air Conditioning Refrigerant is a Hydrofluoroolefin (HFO) that is endorsed by the Environmental Protection Agency and is an ozone-friendly substance with a low global-warming potential. It is recommended that air conditioning service be performed by an authorized dealer using recovery and recycling equipment.

NOTE:

Use only the manufacturer approved A/C system PAG compressor oil, and refrigerants.

Cabin Air Filter Replacement

For the proper maintenance intervals → page 349.

WARNING!

Do not remove the cabin air filter while the vehicle is running, or while the ignition is in the ON/RUN mode. With the cabin air filter removed and the blower operating, the blower can contact hands and may propel dirt and debris into your eyes, resulting in personal injury.

The cabin air filter is located in the fresh air inlet behind the glove compartment. Perform the following procedure to replace the filter:

1. Open the glove compartment and remove all contents.
2. With the glove compartment door open, remove the glove compartment tension tether and tether clip by sliding the clip toward the face of the glove compartment door. Lift the clip out of glove compartment door and release into dash panel.

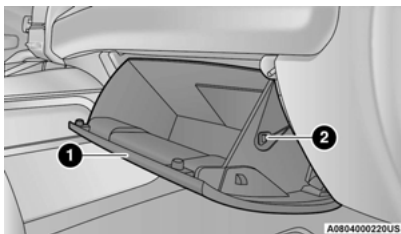

Right Side Of Glove Compartment

- 1 – Glove Compartment Door
 - 2 – Glove Compartment Tension Tether
3. There are glove compartment travel stops on both sides of the glove compartment door. Push inward on both sides of the glove compartment to release the glove compartment travel stops.

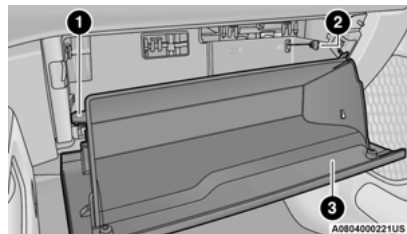

Glove Compartment

- 1 – Glove Compartment Travel Stop
 - 2 – Glove Compartment Tension Tether
 - 3 – Glove Compartment Door
4. Disengage the glove compartment door from its hinges by opening the glove compartment past the travel stop and pulling it toward you.

5. Remove the filter cover by pushing in on the finger tabs on each end of the filter cover.

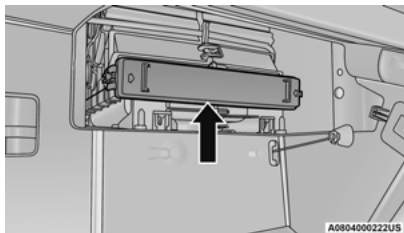

Filter Cover

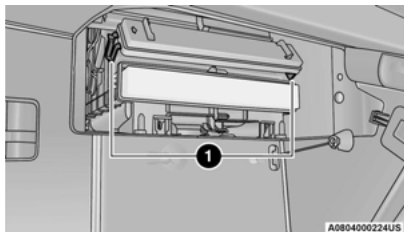

Filter Cover Removal

1 – Finger Tabs

6. Remove the cabin air filter by pulling it straight out of the housing.

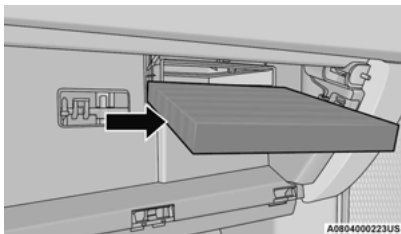

Cabin Air Filter

7. Install the cabin air filter with the arrow on the filter pointing toward the floor. When installing the filter cover, press on each end until you hear an audible click.

CAUTION!

The cabin air filter is identified with an arrow to indicate airflow direction through the filter. Failure to properly install the filter will result in the need to replace it more often.

8. Reinstall the glove compartment on the hinges.
9. Pull the tension tether outward and reinstall the glove compartment past the travel stops by pushing in on the glove compartment sides.

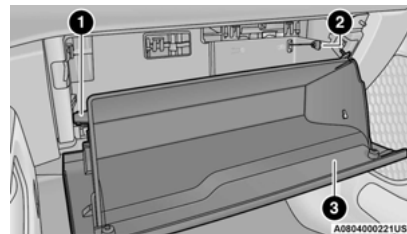

Glove Compartment

- 1 – Glove Compartment Travel Stop
2 – Glove Compartment Tension Tether
3 – Glove Compartment Door

NOTE:

Ensure the glove compartment door hinges and glove compartment travel stops are fully engaged.

10. Reattach the glove compartment tension tether by inserting the tether clip in the glove compartment and sliding the clip away from the face of the glove compartment door.

ACCESSORY DRIVE BELT INSPECTION

WARNING!

- Do not attempt to inspect an accessory drive belt with vehicle running.
- When working near the radiator cooling fan, disconnect the fan motor lead. The fan is temperature controlled and can start at any time

(Continued)

WARNING!

regardless of Start button mode. You could be injured by the moving fan blades.

- You can be badly injured working on or around a motor vehicle. Only do service work for which you have the knowledge and the proper equipment. If you have any doubt about your ability to perform a service job, take your vehicle to a competent mechanic.

When inspecting accessory drive belts, small cracks that run across the ribbed surface of the belt from rib to rib, are considered normal. This is not a reason to replace the belt. However, cracks running along a rib (not across) are not normal. Any belt with cracks running along a rib must be replaced. Also have the belt replaced if it has excessive wear, frayed cords or severe glazing.

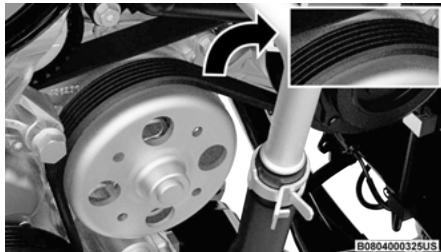

Accessory Belt (Serpentine Belt)

Conditions that would require replacement:

- Rib chunking (one or more ribs has separated from belt body)
- Rib or belt wear
- Longitudinal belt cracking (cracks between two ribs)
- Belt slips
- Groove jumping (belt does not maintain correct position on pulley)
- Belt broken (must identify and correct problem before new belt is installed)
- Noise (objectionable squeal, squeak, or rumble is heard or felt while drive belt is in operation)

Some conditions can be caused by a faulty component such as a belt pulley. Belt pulleys should be carefully inspected for damage and proper alignment.

Belt replacement on some models requires the use of special tools, we recommend having your vehicle serviced at an authorized dealer.

BODY LUBRICATION

Locks and all body pivot points, including such items as seat tracks, door hinge pivot points and rollers, liftgate, tailgate, decklid, sliding doors and hood hinges, should be lubricated periodically. Use a lithium-based grease, such as Mopar® Spray White Lube to assure quiet, easy operation and to protect against rust and wear. Prior to the application of any lubricant, the parts concerned should be wiped clean to remove dust and grit; after lubricating excess oil and grease should be removed. Particular attention should also be given to hood latching components to ensure proper function.

When performing other underhood services, the hood latch release mechanism, and safety catch should be cleaned and lubricated.

The external lock cylinders should be lubricated twice a year, preferably in the Autumn and Spring. Apply a small amount of a high quality lubricant, such as Mopar® Lock Cylinder Lubricant directly into the lock cylinder.

WINDSHIELD WIPER BLADES

Clean the rubber edges of the wiper blades and the windshield periodically with a sponge or soft cloth and a mild nonabrasive cleaner. This will remove accumulations of salt or road film.

Operation of the wipers on dry glass for long periods may cause deterioration of the wiper blades. Always use washer fluid when using the wipers to remove salt or dirt from a dry windshield.

Avoid using the wiper blades to remove frost or ice from the windshield. Keep the blade rubber out of contact with petroleum products such as engine oil, gasoline, etc.

NOTE:

Life expectancy of wiper blades varies depending on geographical area and frequency of use. If chattering, marks, water lines or wet spots are present, clean the wiper blades or replace as necessary.

The wiper blades and wiper arms should be inspected periodically, not just when wiper performance problems are experienced. This inspection should include the following points:

- Wear or uneven edges
- Foreign material

- Hardening or cracking
- Deformation or fatigue

If a wiper blade or wiper arm is damaged, replace the affected wiper arm or blade with a new unit. Do not attempt to repair a wiper arm or blade that is damaged.

Wiper Blade Removal/Installation

CAUTION!

Do not allow the wiper arm to spring back against the glass without the wiper blade in place or the glass may be damaged.

1. Lift the wiper arm to raise the wiper blade off of the glass, until the wiper arm is in the full up position.

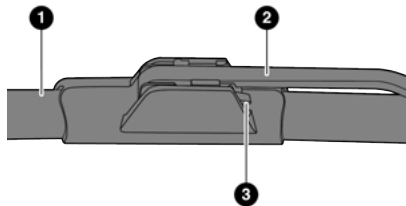

Wiper Blade With Release Tab In Locked Position

- 1 — Wiper Blade
- 2 — Wiper Arm
- 3 — Release Tab

2. To disengage the wiper blade from the wiper arm, press the release tab on the wiper blade and while holding the wiper arm with one hand, slide the wiper blade down towards the base of the wiper arm.

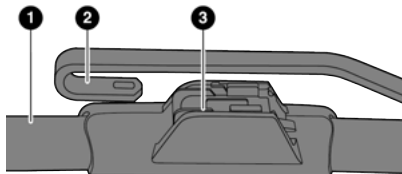

A0804000186US

Wiper Blade With Release Tab In Unlocked Position

- 1 — Wiper Blade
- 2 — Wiper Arm J Hook
- 3 — J Hook Retainer

3. With the wiper blade disengaged, remove the wiper blade from the wiper arm.
4. Gently lower the wiper arm onto the glass.

Installing The Front Wipers

1. Lift the wiper arm off of the glass, until the wiper arm is in the full up position.
2. Position the wiper blade near the hook on the tip of the wiper arm.
3. Slide the wiper blade up into the hook on the wiper arm, latch engagement will be accompanied by an audible click.

4. Gently lower the wiper blade onto the glass.

EXHAUST SYSTEM

The best protection against carbon monoxide entry into the vehicle body is a properly maintained engine exhaust system.

If you notice a change in the sound of the exhaust system; or if exhaust fumes can be detected inside the vehicle; or when the underside or rear of the vehicle is damaged; have an authorized technician inspect the complete exhaust system and adjacent body areas for broken, damaged, deteriorated, or mispositioned parts. Open seams or loose connections could permit exhaust fumes to seep into the passenger compartment. In addition, have the exhaust system inspected each time the vehicle is raised for lubrication or oil changes. Replace as required.

WARNING!

- Exhaust gases can injure or kill. They contain carbon monoxide (CO), which is colorless and odorless. Breathing it can make you unconscious and can eventually poison you. To avoid breathing CO see ➡ page 329.
- A hot exhaust system can start a fire if you park over materials that can burn. Such materials might be grass or leaves coming into contact with your exhaust system. Do not park or operate your vehicle in areas where your exhaust system can contact anything that can burn.

CAUTION!

- The catalytic converter requires the use of unleaded fuel only. Leaded gasoline will destroy the effectiveness of the catalyst as an emissions control device and may seriously reduce engine performance and cause serious damage to the engine.
- Damage to the catalytic converter can result if your vehicle is not kept in proper operating condition. In the event of engine malfunction, particularly involving engine misfire or other apparent loss of performance, have your vehicle serviced promptly. Continued operation of your vehicle with a severe malfunction could cause the converter to overheat, resulting in possible damage to the converter and vehicle.

Under normal operating conditions, the catalytic converter will not require maintenance. However, it is important to keep the engine properly tuned to assure proper catalyst operation and prevent possible catalyst damage.

NOTE:

Intentional tampering with emissions control systems can result in civil penalties being assessed against you.

In unusual situations involving grossly malfunctioning engine operation, a scorching odor may suggest severe and abnormal catalyst overheating. If this occurs, stop the vehicle, turn off the engine and allow it to cool. Service, including a tune-up to manufacturer's specifications, should be obtained immediately.

To minimize the possibility of catalytic converter damage:

- Do not interrupt the ignition when the transmission is in gear and the vehicle is in motion.
- Do not try to start the vehicle by pushing or towing the vehicle.
- Do not idle the engine with any ignition components disconnected or removed, such as during diagnostic testing, or for prolonged periods during very rough idle or malfunctioning operating conditions.

COOLING SYSTEM**WARNING!**

- You or others can be badly burned by hot engine coolant (antifreeze) or steam from your radiator. If you see or hear steam coming from under the hood, do not open the hood until the radiator has had time to cool. Never open a cooling system pressure cap when the radiator or coolant bottle is hot.
- Keep hands, tools, clothing, and jewelry away from the radiator cooling fan when the hood is raised. The fan starts automatically and may start at any time, whether the engine is running or not.
- When working near the radiator cooling fan, disconnect the fan motor lead or turn the ignition to the OFF mode. The fan is temperature controlled and can start at any time the ignition is in the ON mode.

Engine Coolant Checks

Check the engine coolant (antifreeze) protection every 12 months (before the onset of freezing weather, where applicable). If the engine coolant is dirty or rusty in appearance, the system should be drained, flushed and refilled with fresh coolant. Check the front of the A/C condenser (if equipped) or radiator for any accumulation of bugs, leaves, etc. If dirty, clean by gently spraying water from a garden hose vertically down the face of the A/C condenser (if equipped) or the back of the radiator core.

Check the engine cooling system hoses for brittle rubber, cracking, tears, cuts and tightness of the connection at the coolant recovery bottle and radiator. Inspect the entire system for leaks.

DO NOT REMOVE THE COOLANT PRESSURE CAP WHEN THE COOLING SYSTEM IS HOT.

Cooling System — Drain, Flush And Refill**NOTE:**

Some vehicles require special tools to add coolant properly. Failure to fill these systems properly could lead to severe internal engine damage. If any coolant is needed to be added to the system please contact an authorized dealer.

If the engine coolant (antifreeze) is dirty or contains visible sediment, have an authorized dealer clean and flush with OAT coolant (conforming to MS.90032).

For the proper maintenance intervals ⇨ page 349.

Selection Of Coolant

For further information ⇨ page 415.

NOTE:

- Mixing of engine coolant (antifreeze) other than specified Organic Additive Technology (OAT) engine coolant, may result in engine damage and may decrease corrosion protection. OAT engine coolant is different and should not be mixed with Hybrid Organic Additive Technology (HOAT) engine coolant or any “globally compatible” coolant. If a non-OAT engine coolant is introduced into the cooling system in an emergency, the cooling system will need to be drained, flushed, and refilled with fresh OAT coolant (conforming to MS.90032), by an authorized dealer as soon as possible.
- Do not use water alone or alcohol-based engine coolant products. Do not use additional rust inhibitors or anti-rust products, as they may not be compatible with the radiator engine coolant and may plug the radiator.
- This vehicle has not been designed for use with propylene glycol-based engine coolant. Use of propylene glycol-based engine coolant is not recommended.
- Some vehicles require special tools to add coolant properly. Failure to fill these systems properly could lead to severe internal engine damage. If any coolant is needed to be added to the system please contact an authorized dealer.

Adding Coolant

Your vehicle has been built with an improved engine coolant (OAT coolant conforming to MS.90032) that allows extended maintenance intervals. This engine coolant (antifreeze) can be used up to 10 years or 150,000 miles (240,000 km) before replacement. To prevent reducing this extended maintenance period,

it is important to use the same engine coolant (OAT coolant conforming to MS.90032) throughout the life of your vehicle.

Please review these recommendations for using Organic Additive Technology (OAT) engine coolant that meets the requirements of the manufacturer Material Standard MS.90032. When adding engine coolant:

- We recommend using Mopar® Antifreeze/Coolant 10 Year/150,000 Mile (240,000 km) Formula OAT that meets the requirements of the manufacturer Material Standard MS.90032.
- Mix a minimum solution of 50% OAT engine coolant that meets the requirements of the manufacturer Material Standard MS.90032 and distilled water. Use higher concentrations (not to exceed 70%) if temperatures below -34°F (-37°C) are anticipated. Please contact an authorized dealer for assistance.
- Use only high purity water such as distilled or deionized water when mixing the water/engine coolant solution. The use of lower quality water will reduce the amount of corrosion protection in the engine cooling system.

NOTE:

- It is the owner's responsibility to maintain the proper level of protection against freezing according to the temperatures occurring in the area where the vehicle is operated.
- Some vehicles require special tools to add coolant properly. Failure to fill these systems properly could lead to severe internal engine damage. If any coolant is needed to be added to the system, please contact an authorized dealer.

- Mixing engine coolant types is not recommended and can result in cooling system damage. If HOAT and OAT coolant are mixed in an emergency, have an authorized dealer drain, flush, and refill with OAT coolant (conforming to MS.90032) as soon as possible.

Cooling System Pressure Cap

The cap must be fully tightened to prevent loss of engine coolant (antifreeze), and to ensure that engine coolant will return to the radiator from the coolant expansion bottle/recovery tank (if equipped).

The cap should be inspected and cleaned if there is any accumulation of foreign material on the sealing surfaces.

WARNING!

- Do not open a hot engine cooling system. Never add engine coolant (antifreeze) when the engine is overheated. Do not loosen or remove the cap to cool an overheated engine. Heat causes pressure to build up in the cooling system. To prevent scalding or injury, do not remove the pressure cap while the system is hot or under pressure.
- Do not use a pressure cap other than the one specified for your vehicle. Personal injury or engine damage may result.

Disposal Of Used Coolant

Used ethylene glycol-based coolant (antifreeze) is a regulated substance requiring proper disposal. Check with your local authorities to determine the disposal rules for your community. To prevent ingestion by

animals or children, do not store ethylene glycol-based coolant in open containers or allow it to remain in puddles on the ground, clean up any ground spills immediately. If ingested, seek emergency assistance immediately.

Checking Coolant Level — 3.6L Engine

The level of the coolant in the pressurized coolant bottle should be between the “MIN” and “MAX” range on the bottle when the engine is cold.

The radiator normally remains completely full, so there is no need to remove the cap unless checking for coolant freeze point or replacing engine coolant (antifreeze). Advise your service attendant of this.

As long as the engine operating temperature is satisfactory, the coolant bottle need only be checked once a month. When additional engine coolant is needed to maintain the proper level, it should be added to the coolant bottle. Do not overfill.

Cooling System Notes

NOTE:

When the vehicle is stopped after a few miles/kilometers of operation, you may observe vapor coming from the front of the engine compartment. This is normally a result of moisture from rain, snow, or high humidity accumulating on the radiator and being vaporized when the thermostat opens, allowing hot engine coolant (antifreeze) to enter the radiator.

If an examination of your engine compartment shows no evidence of radiator or hose leaks, the vehicle may be safely driven. The vapor will soon dissipate.

- Do not overfill the coolant expansion bottle.

- Check the coolant freeze point in the radiator and in the coolant expansion bottle. If engine coolant needs to be added, the contents of the coolant expansion bottle must also be protected against freezing.
- If frequent engine coolant additions are required, the cooling system should be pressure tested for leaks.
- Maintain engine coolant concentration at a minimum of 50% OAT coolant (conforming to MS.90032) and distilled water for proper corrosion protection of your engine which contains aluminum components.
- Make sure that the coolant expansion bottle overflow hoses are not kinked or obstructed.
- Keep the front of the radiator clean. If your vehicle is equipped with air conditioning, keep the front of the condenser clean.
- Do not change the thermostat for Summer or Winter operation. If replacement is ever necessary, install ONLY the correct type thermostat. Other designs may result in unsatisfactory engine cooling performance, poor gas mileage, and increased emissions.

BRAKE SYSTEM

In order to ensure brake system performance, all brake system components should be inspected periodically ➔ page 349.

WARNING!

Riding the brakes can lead to brake failure and possibly a collision. Driving with your foot resting or

(Continued)

WARNING!

riding on the brake pedal can result in abnormally high brake temperatures, excessive lining wear, and possible brake damage. You would not have your full braking capacity in an emergency.

Fluid Level Check — Brake Master Cylinder

The fluid level of the brake master cylinder should be checked whenever the vehicle is serviced, or immediately if the Brake System Warning Light is on. If necessary, add fluid to bring level within the designated marks on the side of the reservoir of the brake master cylinder. Be sure to clean the top of the master cylinder area before removing cap. With disc brakes, fluid level can be expected to fall as the brake pads wear. Brake fluid level should be checked when pads are replaced. If the brake fluid is abnormally low, check the system for leaks ➔ page 417.

WARNING!

- Use only manufacturer's recommended brake fluid. Using the wrong type of brake fluid can severely damage your brake system and/or impair its performance. The proper type of brake fluid for your vehicle is also identified on the original factory installed hydraulic master cylinder reservoir.
- To avoid contamination from foreign matter or moisture, use only new brake fluid or fluid that has been in a tightly closed container. Keep the

(Continued)

WARNING!

master cylinder reservoir cap secured at all times. Brake fluid in an open container absorbs moisture from the air resulting in a lower boiling point. This may cause it to boil unexpectedly during hard or prolonged braking, resulting in sudden brake failure. This could result in a collision.

- Overfilling the brake fluid reservoir can result in spilling brake fluid on hot engine parts, causing the brake fluid to catch fire. Brake fluid can also damage painted and vinyl surfaces, care should be taken to avoid its contact with these surfaces.
- Do not allow petroleum based fluid to contaminate the brake fluid. Brake seal components could be damaged, causing partial or complete brake failure. This could result in a collision.

AUTOMATIC TRANSMISSION**Special Additives**

The manufacturer strongly recommends against using any special additives in the transmission. Automatic Transmission Fluid (ATF) is an engineered product and its performance may be impaired by supplemental additives. Therefore, do not add any fluid additives to the transmission. Avoid using transmission sealers as they may adversely affect seals.

CAUTION!

Do not use chemical flushes in your transmission as the chemicals can damage your transmission

(Continued)

CAUTION!

components. Such damage is not covered by the New Vehicle Limited Warranty.

Fluid Level Check

The fluid level is preset at the factory and does not require adjustment under normal operating conditions. Routine fluid level checks are not required, therefore the transmission has no dipstick. An authorized dealer can check your transmission fluid level using special service tools.

If you notice fluid leakage or transmission malfunction, visit an authorized dealer immediately to have the transmission fluid level checked. Operating the vehicle with an improper fluid level can cause severe transmission damage.

CAUTION!

If a transmission fluid leak occurs, visit an authorized dealer immediately. Severe transmission damage may occur. An authorized dealer has the proper tools to adjust the fluid level accurately.

Fluid And Filter Changes

Under normal operating conditions, the fluid installed at the factory will provide satisfactory lubrication for the life of the vehicle.

Routine fluid and filter changes are not required. However, change the fluid and filter if the fluid becomes contaminated (with water, etc.), or if the transmission is disassembled for any reason.

Selection Of Lubricant

It is important to use the proper transmission fluid to ensure optimum transmission performance and life. Use only the manufacturer recommended transmission fluid ⇨ page 417. It is important to maintain the transmission fluid at the correct level using the recommended fluid. No chemical flushes should be used in any transmission; only the approved lubricant should be used.

CAUTION!

Using a transmission fluid other than the manufacturer's recommended fluid may cause deterioration in transmission shift quality and/or torque converter shudder.

REAR AXLE AND 4x4 FRONT DRIVING AXLE FLUID LEVEL

For normal service, periodic fluid level checks are not required. When the vehicle is serviced for other reasons the exterior surfaces of the axle assembly should be inspected. If gear oil leakage is suspected inspect the fluid level ⇨ page 417. This inspection should be made with the vehicle in a level position.

The fluid level should be even with the bottom of the fill hole (within 1/4 in (6.4 mm) of edge of hole) for the front axle and rear axle.

Drain And Refill

For the proper maintenance intervals ⇨ page 349.

Lubricant Selection

For further information ⇨ page 417.

NOTE:

The presence of water in the gear lubricant will result in corrosion and possible failure of differential components. Operation of the vehicle in water, as may be encountered in some off-highway types of service, will require draining and refilling the axle to avoid damage.

Limited-Slip Differentials

Rear axles equipped with a Limited Slip Differential require that 5 oz. (148 ml) Mopar® Limited Slip Additive be added to the gear lubricant ⇨ page 417. The Mopar® Limited Slip Additive should be added to the gear lubricant whenever a fluid change is made to an axle equipped with a Limited Slip Differential.

NOTE:

When refilling a limited slip differential axle which requires a friction modification additive, the additive should be added before the gear lubricant to ensure proper additive fill.

TRANSFER CASE

Fluid Level Check

This fluid level can be checked by removing the filler plug. The fluid level should be to the bottom edge of the filler plug hole (or within 1/8 inch of the bottom) with the vehicle in a level position.

Drain And Refill

For the proper maintenance intervals ⇨ page 349.

Selection Of Lubricant

Use only the manufacturer recommended fluid ⇨ page 417.

FUSES

General Information

WARNING!

- When replacing a blown fuse, always use an appropriate replacement fuse with the same amp rating as the original fuse. Never replace a fuse with another fuse of higher amp rating. The use of a fuse with a rating other than indicated may result in a dangerous electrical system overload. If a properly rated fuse continues to blow, it indicates a problem in the circuit that must be corrected. Never replace a blown fuse with metal wires or any other material. Do not place a fuse inside a circuit breaker cavity or vice versa. Failure to use proper fuses may result in serious personal injury, fire and/or property damage.
- Before replacing a fuse, make sure that the ignition is off and that all the other services are switched off and/or disengaged.
- If the replaced fuse blows again, contact an authorized dealer.

(Continued)

WARNING!

- If a general protection fuse for safety systems (air bag system, braking system), power unit systems (engine system, transmission system) or steering system blows, contact an authorized dealer.

CAUTION!

If it is necessary to wash the underhood compartment, take care not to directly hit the fuse box and the windshield wiper motors with water.

The fuses protect electrical systems against excessive current.

When a device does not work, you must check the fuse element inside the blade fuse for a break/melt.

Also, please be aware that using power outlets for extended periods of time with the engine off may result in vehicle battery discharge.

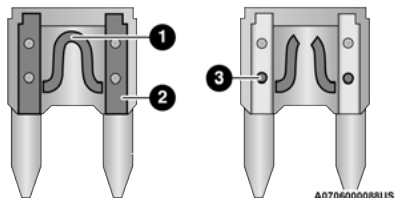

Blade Fuses

- 1 — Fuse Element
 2 — Blade Fuse with a good/functional fuse element
 3 — Blade Fuse with a bad/not functional fuse element (blown fuse)

Underhood Power Distribution Center

The Power Distribution Center is located in the engine compartment near the battery. This center contains cartridge fuses, micro fuses, relays, and circuit breakers. A description of each fuse and component may be stamped on the inside cover, otherwise the cavity number of each fuse is stamped on the inside cover that corresponds to the following chart.

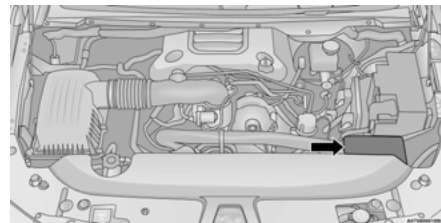

Underhood Power Distribution Center

CAUTION!

When installing the power distribution center cover, it is important to ensure the cover is properly positioned and fully latched. Failure to do so may allow water to get into the power distribution center and possibly result in an electrical system failure.

Cavity	Cartridge Fuse	Micro Fuse	DESCRIPTION
If Equipped*			
N1	150 Amp Gray	-	AUX PDC*
N2	300 Amp Gray	-	ALTERNATOR/ PPU*
N3	Shunt	-	AUX BATTERY*
N4	300 Amp Gray	-	INVERTER*
N5	80 Amp Gray	-	Interior PDC Feed #2
N6	80 Amp Gray	-	Interior PDC Feed #1

Cavity	Cartridge Fuse	Micro Fuse	DESCRIPTION
N7	80 Amp Gray	-	ELEC PWR STR #2
N8	100 Amp Gray	-	RAD FAN
N9	Shunt	-	CRANK BATTERY
N10	80 Amp Gray	-	ELEC PWR STR #1
F01	-	-	SPARE*
F02	-	15 Amp Blue	LTR COOLANT PUMP*
F03	-	15 Amp Blue	SSMD / SSMP*
F04	-	5 Amp Tan	IBS #2*
F05	-	15 Amp Blue	AGS / RR AXLE CL VLV / ACTIVE AIR DAM / LCVN
F06	-	-	SPARE*
F07	-	20 Amp Yellow	ADJ PEDALS*
F08	-	15 Amp Blue	MOD CLUSTER
F09	-	25 Amp Clear	FUEL PMP MTR / ASSY FUEL TANK*
F10	-	-	SPARE*
F11	-	20 Amp Yellow	CADM - MID*

Cavity	Cartridge Fuse	Micro Fuse	DESCRIPTION
F12	-	20 Amp Yellow	SLM FEED_LT
F13	-	20 Amp Yellow	SLM FEED_RT
F14	-	5 Amp Tan	MGU*
F15	-	-	SPARE*
F16	-	20 Amp Yellow	CADM - MAP*
F17	-	10 Amp Red	ECM (VOLTAGE SENSE)*
F18	-	5 Amp Tan	IBS #1
F19	-	10 Amp Red	IRCAM HEATER
F20	20 Amp Blue	-	AUX SWITCH #6*
F21	-	-	SPARE*
F22	-	10 Amp Red	GNMM / VMPS*
F23	-	15 Amp Blue	MOD CVADAS
F24	30 Amp Pink	-	BSM #2 VALVES*
F25	40 Amp Green	-	STARTER
F26	-	-	SPARE*

Cavity	Cartridge Fuse	Micro Fuse	DESCRIPTION
F27	-	-	SPARE*
F28	-	-	SPARE*
F29	25 Amp White	-	ITCM #1 - LIGHTS
F30	40 Amp Green	-	BCM 4 - POWER LOCKS
F31	50 Amp Red	-	BSM #2 MTR*
F32	50 Amp Red	-	BCM 2 - EXTERIOR LIGHTS 2
F33	50 Amp Red	-	BSM #1 - VALVES
F34	50 Amp Red	-	IAIR SUSP*
F35	-	-	SPARE*
F36	50 Amp Red	-	BSM #1 - MTR
F37	20 Amp Blue	-	AUX SWITCH #5*
F38	-	10 Amp Red	ECM
F39	-	30 Amp Green	IAIR SUSP*
F40	-	20 Amp Yellow	HORN
F41	-	-	SPARE*

Cavity	Cartridge Fuse	Micro Fuse	DESCRIPTION
F42	-	-	SPARE*
F43	30 Amp Pink	-	PWR TAILGATE
F44	30 Amp Pink	-	DTCM
F45	25 Amp White	-	ITCM #2 - LIGHTS
F46	-	-	SPARE*
F47	-	-	SPARE*
F48	-	-	SPARE*
F49	-	20 Amp Yellow	TCM SBW
F50	-	-	SPARE*
F51	-	10 Amp Red	OUTPUT TO UPFITTER PDC*
F52	-	10 Amp Red	PCR CTRL FEED*
F53	-	-	SPARE*
F54	-	-	SPARE*
F55	-	10 Amp Red	DTCM / SW ENG MOUNT 1 & 2 / BSM #2
F56	-	10 Amp Red	ECM / PPU MGU WAKE UP / BSM #1 / SLM

Cavity	Cartridge Fuse	Micro Fuse	DESCRIPTION
F57	-	10 Amp Red	EPS
F58	-	-	SPARE*
F59	-	10 Amp Red	DALM*
F60	-	10 Amp Red	ADCM*
F61	-	20 Amp Yellow	MGU COOL PMP / ADCM*
F62	-	10 Amp Red	TRAILER CAMERA*
F63	-	25 Amp Clear	INJ / IGN COIL / ISCM
F64	-	15 Amp Blue	SOL / OIL LVL SNSR / 02 HTR / VAPOR BLOCKING VLV (BSG)
F65	-	20 Amp Yellow	ECM / ACT SHORT RUNNER VALVE
F66	-	-	SPARE*
F67	-	10 Amp Red	AC CLUTCH
F68	-	-	SPARE*
F69	30 Amp Pink	-	REAR DEFROSTER*
F70	-	-	SPARE*
F71	25 Amp White	-	FUEL PUMP MOTOR #2*

Cavity	Cartridge Fuse	Micro Fuse	DESCRIPTION
F72	25 Amp White	-	FUEL PUMP MOTOR #1*
F73	-	-	SPARE*
F74	-	-	SPARE*
F75	30 Amp Pink	-	PWR SIDE STEP*
F76	-	-	SPARE*
F77	-	-	SPARE*
F78	-	-	SPARE*
F79	-	-	SPARE*
F80	-	-	SPARE*
F81	20 Amp Blue	-	ECM
F82	-	-	SPARE*
F83	-	-	SPARE*
F84	-	-	SPARE*
F85	-	-	SPARE*
F86	30 Amp Pink	-	FRT WPR

Cavity	Cartridge Fuse	Micro Fuse	DESCRIPTION
F87	40 Amp Green	-	HVAC BLOWER MOTOR
F88	-	-	SPARE*

Interior Power Distribution Center

The Power Distribution Center is located under the driver's side instrument panel. This center contains cartridge fuses, micro fuses, relays, and circuit breakers.

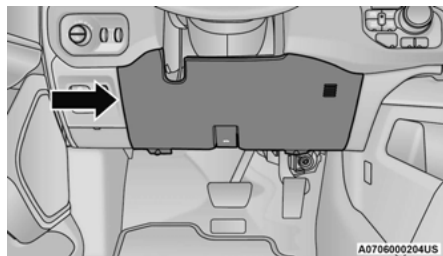

Fuse Cover Panel

See the following steps for accessing the interior fuses:

1. Locate and remove the two screws from the lower portion of the fuse panel cover.

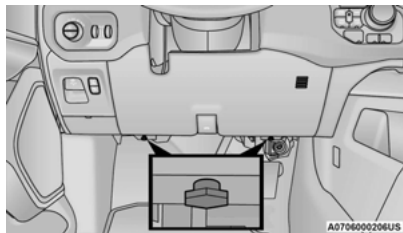

Fuse Panel Screw Locations

2. After removing the screws, gently pull both the left and right side of the fuse panel cover to release the fastener clips.

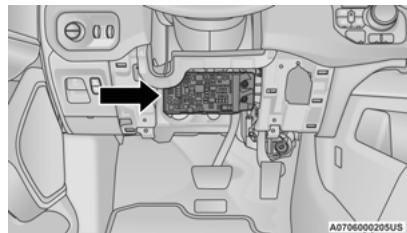

Interior Fuse Box Location

3. Reverse the procedure to reinstall the fuse panel cover.

Internal Fuse Chart

Cavity	Cartridge Fuse	Micro Fuse	Description
* If Equipped			
F01	30 Amp Pink	-	Assy Trailer Tow Receptacle

Cavity	Cartridge Fuse	Micro Fuse	Description
* If Equipped			
F02	30 Amp Pink	-	Mod Memory Seat Driver/ Power Seat Driver
F03	-	-	Spare
F04	-	5 Amp Tan	Smart Door Handle Drvr
F05	-	25 Amp Clear	Mod Audio Amplifier/ Mod Active Noise Cancellation
F06	40 Amp Green	-	Mod BCM Feed #3 (Interior Lights)
F07	40 Amp Green	-	Mod Integration Trailer Brake Module (ITBM)
F08	-	15 Amp Blue	SNSR UWB (1-7)*
F09	-	-	Spare
F10	-	-	Spare
F11	-	10 Amp Red	Animation Lighting Rr Rt
F12	-	-	Spare
F13	-	-	Spare
F14	-	15 Amp Blue	Central ADAS Decision Mod CADM LO
F15 A	-	10 Amp Red	Mod Occupant Class / Integrated Trailer Control Module (ITCM)/ Mod HVAC Control / Mod I Air Suspension*

Cavity	Cartridge Fuse	Micro Fuse	Description
* If Equipped			
F15 B	-	10 Amp Red	Parktronic System Mod (PTS)
F16	-	-	Spare
F17	-	5 Amp Tan	MOD SGW (Cybersecurity)
F18	30 Amp Pink	-	Mtr Sunshade Sunroof / Mtr Sunshade Sunroof-Dual Pane / Mtr Sunshade Sunroof-Singlepane / Lamp Dome
F19	-	20 Amp Yellow	Module PPU Cooling Fan*
F20	-	-	Spare
F21	-	-	Spare
F22	-	20 Amp Yellow	MOD CRSM (Heat Seat RR RT)
F23	-	-	Spare
F24	-	10 Amp Red	Wireless Charging Pad - Passenger / Mod Spaak*
F25	-	-	Spare
F26	-	10 Amp Red	Mod Cluster CCN / Mod SGW (Cybersecurity)
F27	-	15 Amp Blue	MOD RF HUB / Module Ignition
F28	-	-	Spare

Cavity	Cartridge Fuse	Micro Fuse	Description
* If Equipped			
F29	-	20 Amp Yellow	Module Seat Heater FRT (PASS)
F30	-	-	Spare
F31	20 Amp Blue	-	Smart Motor RR RT
F32	-	-	Spare
F33	-	15 Amp Blue	MOD DCSD
F34	-	20 Amp Yellow	Module Seat Heater FRT (Driver)
F35	-	10 Amp Red	Driver Monitoring Camera*
F36	50 Amp Red	-	Mod_BCM Feed #1 (Exterior Lights #1)
F37	-	20 Amp Yellow	MOD CRSM (Hear Seat RR LT)
F38	-	-	Spare
F39	-	-	Spare
F40	-	-	Spare
F41A	-	10 Amp Red	MOD ORC
F41B	-	-	Spare

Cavity	Cartridge Fuse	Micro Fuse	Description
* If Equipped			
F42 A	-	-	Spare
F42B	-	-	Spare
F43A	-	-	Spare
F43B	-	-	Spare
F44	-	20 Amp Yellow	MOD CMCM (Radio)
F45	30 Amp Pink	-	MOD DOOR MUXDRIVER
F46	30 Amp Pink	-	MOD DOOR MUXPASSENGER
F47A	-	-	Spare
F47B	-	-	Spare
F48A	-	10 Amp Red	Assy Overhead Console OHC W/ Sunshade / SW 911/ SW Assist/ Head's Up Display (HUD)/ Humidity Rain Light
F48B	-	10 Amp red	Animation Lighting RR-LT
F49	-	15 Amp Blue	Mod Seat Heater FRT (STRNG WHL)
F50A	-	-	Spare
F50B	-	10 Amp Red	Port Diagnostic 1 & 2

Cavity	Cartridge Fuse	Micro Fuse	Description
* If Equipped			
F51A	-	10 Amp Red	Mod TCSM/ Mod SBW/ SW Park Brake Electronic/ Mod Tire Pressure Trailer TPM/ Transfer Case SW/ Automatic Gear Shifter Module (AGSM)
F51B	-	10 Amp Red	SW Seat Vent LT & RT/ Wireless Charging Pad Driver
F52	-	-	Spare
F53	-	15 Amp Blue	Front Passenger Display Module (FPDM) / Port UCI Dual USB Frt/ Port UCI 2 USB-RR/ Mod TBM (Telematics Box Mod)/ Trailer Steering Control Knob
F54 A&B	-	20 Amp Yellow	Power Outlet-Center Seat - Battery Feed Power Outlet-Center Seat - IGN Feed
F55	-	-	Spare
F56	30 Amp Pink	-	Mod Memory Seat Passenger/ Power Seat Passenger
F57	-	-	Spare
F58	-	-	Spare
F59	-	-	Spare
F60	50 Amp Red	-	Mod Inverter 400W
F61	20 Amp Blue	-	Smart Motor RR LT

Cavity	Cartridge Fuse	Micro Fuse	Description
* If Equipped			
F62A	-	10 Amp Red	Assy Mirror Inside RR View / Port Power Or USB IP USB Charge Only/ USB Port RR Armrest
F62B	-	10 Amp Red	Mod Inverter (Wake Up)/ MTR Sunroof Dual Pane/ MTR Sunshade Sunroof/ USB Charge Only/ Port Media Hub FPD/ Port Video USB/ Mod Inverter - 2kw (Wake Up)*
F63A	-	15 Amp Blue	Lumbar Support DR & PASS SW
F63B		15 Amp Blue	Mod ICS Switch Bank/ Mod HVAC Ctrl/ Sw Bank Upper/ Mod Ctrl Steering/ RR Window Sw/Sw Bank Second
F64A	-	10 Amp Red	PPU Battery Pack Control MOD (BPCM)*
F64B	-	10 Amp Red	MOD ORC
F65	-	5 Amp Tan	Smart Door Handle Pass
F66	-	25 Amp Clear	MOD Amplifier Feed #2

Circuit Breakers

Cavity	Circuit Breaker	Description
CB1	-	Spare
CB2	-	Spare

Cavity	Circuit Breaker	Description
CB3	-	Spare
CB4	-	Spare
CB5	25 Amp	Power Window Rearview
CB6	-	Spare

Auxiliary Switches – If Equipped

Four or six auxiliary switches may be located in the lower switch bank of the instrument panel, and can be used to power various electrical devices.

The functionality of the auxiliary switches can be changed via the Uconnect Settings. All switches can be configured for setting the switch type operation to latching or momentary, power source of either battery or ignition, and ability to hold last state across key cycles.

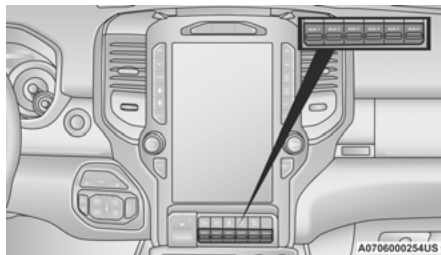

Auxiliary Switch Location

The auxiliary switches manage the relays that power four or six blunt cut wires. These wires are located under the hood to the right, near the battery.

In addition to the four or six auxiliary switch wires, a fused battery wire and ignition wire are also found in this location.

A kit of splices and heat shrink tubing are provided with the auxiliary switches to aid in the connection/ installation of your electrical devices.

NOTE:

Holding last state conditions are met when switch type is set to “latching” and power source is set to “ignition” within Uconnect Settings.

Fuse And Wire Color Chart**NOTE:**

Fuses for the auxiliary switches can be found in the auxiliary Power Distribution Center (PDC), located in the engine compartment toward the front of the vehicle, in front of the main PDC. Remove upper shield to access. If equipped, additional auxiliary switch fuses will be located in the main PDC.

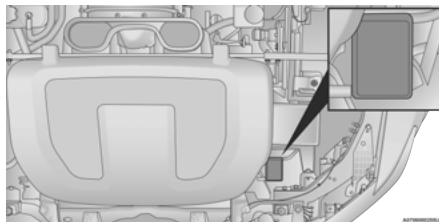
**Auxiliary PDC Location**

Circuit Function	Fuse	Wire Color	Location
* If Equipped			
Aux Switch 1	F001A - 50 Amp	Pink/Dark Blue	Underhood PDC
Aux Switch 2	F002A - 20 Amp	Pink/Dark Green	Underhood PDC
Aux Switch 3	F003A - 20 Amp	Pink/Violet	Underhood PDC
Aux Switch 4	F004A - 50 Amp	Pink/Beige	Underhood PDC
Aux Switch 5*	F37 - 20 Amp	Pink/Brown	Underhood PDC
Aux Switch 6*	F20 - 20 Amp	Pink/Yellow	Underhood PDC

BULB REPLACEMENT

Replacement Bulbs, Names, And Part Numbers

In the instance a bulb needs to be replaced, this section includes bulb description and replacement part numbers. All of the inside bulbs are brass or glass-wedge base. Aluminum base bulbs are not approved.

NOTE:

See an authorized dealer for LED bulb replacement.

Interior Bulbs	
Bulb Name	Bulb Number
Overhead Console Lamps	TS 212-9
Dome Lamp	7679
NOTE: For lighted switches, see an authorized dealer for replacement instructions.	

Exterior Bulbs	
Bulb Name	Bulb Number
Low & High Beam (LED Reflector Headlamp)	LED
Low & High Beam (LED Projector Headlamp)	LED

Exterior Bulbs	
Bulb Name	Bulb Number
Turn Signal / Front Position (LED Reflector Headlamp - If Equipped)	7444NA
Turn Signal / Front Position (LED Projector Headlamps - If Equipped)	LED
Front Side Marker	LED
Front Fog Lamps	LED
Side Indicators (Front And Side View Mirror - If Equipped)	LED
Base Rear Tail/Turn and Stop Lamp	7440LL/W21WLL
Premium Rear Tail/Turn/Backup and Stop Lamp	LED
Base Backup Lamp	7440/W21W
Center High Mounted Stop Lamp (CHMSL)	921
Cargo Lamp	921

Exterior Bulbs	
Bulb Name	Bulb Number
Rear License Plate Lamp	LED
Base Turn Lamp	7440NA / WY21W

Replacing Exterior Bulbs

BASE QUAD: LOW BEAM HEADLAMP, HIGH BEAM HEADLAMP, FRONT PARK AND TURN — IF EQUIPPED

Please see an authorized dealer for service on LED lamps.

LED Reflector Headlamp

Front Park And Turn

See the following steps to replace:

1. Open the hood.
2. Disconnect and isolate the negative battery cable.

3. Locate the park and turn socket, which can be found on the back side of the headlamps.

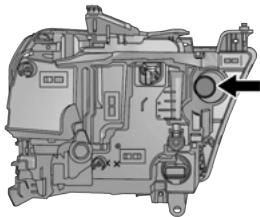

0833202757EM

Park And Turn Socket

4. Reach behind the headlamp and unlock the park and turn socket from the lamp by rotating counterclockwise a quarter turn.
5. Pull the bulb straight out from the housing.
6. Separate the bulb from the socket without twisting.
7. Reverse the procedure for installation of new bulb and covers.

FOG LAMPS

Please see an authorized dealer for service on LED front fog lamps.

REAR TAIL/STOP, TURN SIGNAL AND BACKUP LAMPS

1. Remove the two screws and pushpin retainers that pass through the bed sheet metal.

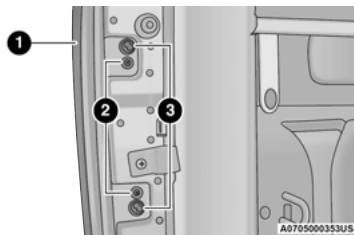

Tail Lamp Locations

- 1 — Tail Lamp
 - 2 — Fasteners
 - 3 — Pushpin Retainers
2. Pull the outboard side of the lamp rearward far enough to unsnap the two receptacles on the outboard side of the lamp housing from the two plastic snap post retainers in the outer box side panel.

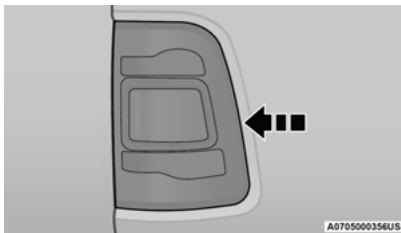

Tail Lamp Removal

3. Disconnect the wiring harness connectors from the bulb socket.

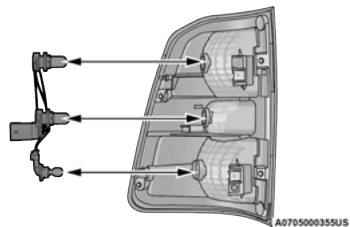

A0705000355US

Wiring Harness Connector

4. Rotate the bulb socket counterclockwise a quarter turn to unlock it from the housing.
5. Pull the bulb straight out of the socket.

CAUTION!

Do not contaminate the bulb glass by touching it with your fingers or by allowing it to contact other oily surfaces. Shortened bulb life will result.

6. Reverse the procedure to install the bulb and housing.

CENTER HIGH MOUNTED STOP LAMP (CHMSL) WITH CARGO LAMP

See the following steps to replace:

1. Remove the four screws holding the housing/lens to the body as shown.

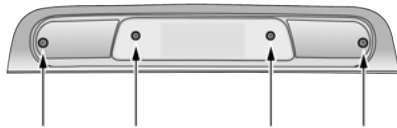

A0705000357U5

CHMSL Mounting Screw Locations

2. Separate the connector holding the housing and wiring harness to the body.

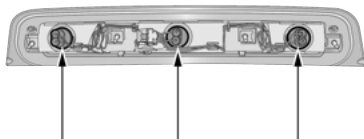

A0705000358U5

CHMSL Bulb Location

3. Turn the desired bulb socket a quarter turn counterclockwise and remove the socket and bulb from housing.
4. Pull the desired bulb straight from the socket.

- Outside Bulbs: Cargo Lamps
- Inside Bulb: Center High Mounted Stop Lamp

CAUTION!

Do not contaminate the bulb glass by touching it with your fingers or by allowing it to contract other oily surfaces. Shortened bulb life will result.

5. Reverse the procedure for installation of bulbs and housing.

TIRES

TIRE SAFETY INFORMATION

Tire safety information will cover aspects of the following information: Tire Markings, Tire Identification Numbers, Tire Terminology and Definitions, Tire Pressures, and Tire Loading.

Tire Markings

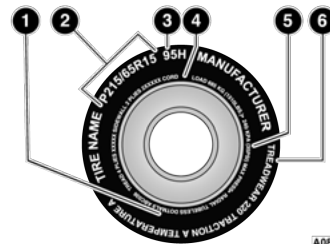

A0806000022U5

Tire Markings

- 1 – US DOT Safety Standards Code (TIN)
- 2 – Size Designation
- 3 – Service Description
- 4 – Maximum Load
- 5 – Maximum Pressure
- 6 – Treadwear, Traction and Temperature Grades

NOTE:

- P (Passenger) – Metric tire sizing is based on US design standards. P-Metric tires have the letter “P” molded into the sidewall preceding the size designation. Example: P215/65R15 95H.
- European – Metric tire sizing is based on European design standards. Tires designed to this standard have the tire size molded into the sidewall beginning

with the section width. The letter "P" is absent from this tire size designation. Example: 215/65R15 96H.

- LT (Light Truck) — Metric tire sizing is based on US design standards. The size designation for LT-Metric tires is the same as for P-Metric tires except for the letters "LT" that are molded into the

sidewall preceding the size designation. Example: LT235/85R16.

- Temporary spare tires are designed for temporary emergency use only. Temporary high pressure compact spare tires have the letter "T" or "S"

molded into the sidewall preceding the size designation. Example: T145/80D18 103M.

- High flotation tire sizing is based on US design standards and it begins with the tire diameter molded into the sidewall. Example: 31x10.5 R15 LT.

TIRE SIZING CHART

EXAMPLE:

Example Size Designation: P215/65R15XL 95H, 215/65R15 96H, LT235/85R16C, T145/80D18 103M, 31x10.5 R15 LT

P = Passenger car tire size based on US design standards, or

"....blank...." = Passenger car tire based on European design standards, or

LT = Light truck tire based on US design standards, or

T or S = Temporary spare tire or

31 = Overall diameter in inches (in)

215, 235, 145 = Section width in millimeters (mm)

65, 85, 80 = Aspect ratio in percent (%)

- Ratio of section height to section width of tire, or

10.5 = Section width in inches (in)

R = Construction code

- "R" means radial construction, or
- "D" means diagonal or bias construction

EXAMPLE:
15, 16, 18 = Rim diameter in inches (in)
Service Description:
95 = Load Index <ul style="list-style-type: none"> ● A numerical code associated with the maximum load a tire can carry
H = Speed Symbol <ul style="list-style-type: none"> ● A symbol indicating the range of speeds at which a tire can carry a load corresponding to its load index under certain operating conditions ● The maximum speed corresponding to the speed symbol should only be achieved under specified operating conditions (i.e., tire pressure, vehicle loading, road conditions, and posted speed limits)
Load Identification: Absence of the following load identification symbols on the sidewall of the tire indicates a Standard Load (SL) tire: <ul style="list-style-type: none"> ● XL = Extra load (or reinforced) tire, or ● LL = Light load tire or ● C, D, E, F, G = Load range associated with the maximum load a tire can carry at a specified pressure
Maximum Load – Maximum load indicates the maximum load this tire is designed to carry
Maximum Pressure – Maximum pressure indicates the maximum permissible cold tire inflation pressure for this tire

Tire Identification Number (TIN)

The Tire Identification Number (TIN) may be found on one or both sides of the tire; however, the date code may only be on one side. Tires with white sidewalls will have the full TIN, including the date code, located on the white sidewall side of the tire. Look for the TIN on the outboard side of black sidewall tires as mounted on the vehicle. If the TIN is not found on the outboard side, then you will find it on the inboard side of the tire.

EXAMPLE:
DOT MA L9 ABCD 0301
<p>DOT = Department of Transportation</p> <ul style="list-style-type: none"> • This symbol certifies that the tire is in compliance with the US Department of Transportation tire safety standards and is approved for highway use
<p>MA = Code representing the tire manufacturing location (two digits)</p>
<p>L9 = Code representing the tire size (two digits)</p>
<p>ABCD = Code used by the tire manufacturer (one to four digits)</p>
<p>03 = Number representing the week in which the tire was manufactured (two digits)</p> <ul style="list-style-type: none"> • 03 means the 3rd week
<p>01 = Number representing the year in which the tire was manufactured (two digits)</p> <ul style="list-style-type: none"> • 01 means the year 2001 • Prior to July 2000, tire manufacturers were only required to have one number to represent the year in which the tire was manufactured. Example: 031 could represent the 3rd week of 1981 or 1991

Tire Terminology And Definitions

Term	Definition
B-pillar	The vehicle B-pillar is the structural member of the body located behind the front door.
Cold Tire Inflation Pressure	Cold tire inflation pressure is defined as the tire pressure after the vehicle has not been driven for at least three hours, or driven less than 1 mile (1.6 km) after sitting for a minimum of three hours. Inflation pressure is measured in units of psi (pounds per square inch) or kPa (kilopascals).

Term	Definition
Maximum Inflation Pressure	The maximum inflation pressure is the maximum permissible cold tire inflation pressure for this tire. The maximum inflation pressure is molded into the sidewall.
Recommended Cold Tire Inflation Pressure	The manufacturer's recommended cold tire inflation pressure as shown on the tire placard.
Tire Placard	A label permanently attached to the vehicle describing the vehicle's loading capacity, the original equipment tire sizes and the recommended cold tire inflation pressures.

Tire Loading And Tire Pressure

NOTE:

The proper cold tire inflation pressure is listed on the driver's side B-pillar or the rear edge of the driver's side door.

Check the inflation pressure of each tire, including the spare tire (if equipped), at least monthly and inflate to the recommended pressure for your vehicle.

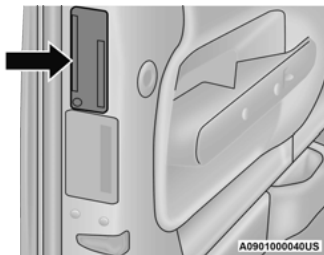

Example Tire Placard Location (Door)

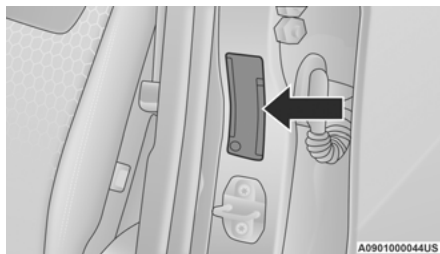

Example Tire Placard Location (B-pillar)

Tire And Loading Information Placard

TIRE AND LOADING INFORMATION			
	SEATING CAPACITY - TOTAL 5		FRONT 2 REAR 3
THE COMBINED WEIGHT OF OCCUPANTS AND GEAR/SHOULD NEVER EXCEED: XXXX KG OR XXXX LBS.			
TIRE	FRONT	REAR	SPARE
ORIGINAL TIRE SIZE:	P195/70R14	P195/70R14	T125/70D15
COLD TIRE INFLATION PRESSURE	200kPa, 29PSI	200kPa, 29PSI	420kPa, 60PSI
SEE OWNER'S MANUAL FOR ADDITIONAL INFORMATION			4N100068

811650a

Tire And Loading Information Placard

This placard tells you important information about the:

1. Number of people that can be carried in the vehicle.
2. Total weight your vehicle can carry.
3. Tire size designed for your vehicle.
4. Cold tire inflation pressures for the front, rear, and spare tires.

Loading

The vehicle maximum load on the tire must not exceed the load carrying capacity of the tire on your vehicle. You will not exceed the tire's load carrying capacity if you adhere to the loading conditions, tire size, and cold tire inflation pressures specified on the Tire And Loading Information Placard in Vehicle Loading ➞ page 205.

NOTE:

Under a maximum loaded vehicle condition, Gross Axle Weight Rating (GAWR) for the front and rear axles must not be exceeded.

For further information on GAWR, vehicle loading, and trailer towing ➞ page 205.

To determine the maximum loading conditions of your vehicle, locate the statement "The combined weight of occupants and cargo should never exceed XXX kg or XXX lbs" on the Tire And Loading Information Placard. The combined weight of occupants, cargo/luggage and trailer tongue weight (if applicable) should never exceed the weight referenced here.

Steps For Determining Correct Load Limit

(1) Locate the statement "The combined weight of occupants and cargo should never exceed XXX kg or XXX lbs." on your vehicle's placard.

(2) Determine the combined weight of the driver and passengers that will be riding in your vehicle.

(3) Subtract the combined weight of the driver and passengers from XXX kg or XXX lbs.

(4) The resulting figure equals the available amount of cargo and luggage load capacity. For example, if "XXX" amount equals 1400 lbs. and there will be five 150 lb passengers in your vehicle, the amount of available cargo and luggage load capacity is 650 lbs. $(1400 - 750 (5 \times 150) = 650 \text{ lbs.})$

(5) Determine the combined weight of luggage and cargo being loaded on the vehicle. That weight may not safely exceed the available cargo and luggage load capacity calculated in Step 4.

(6) If your vehicle will be towing a trailer, load from your trailer will be transferred to your vehicle. Consult this manual to determine how this reduces the available cargo and luggage load capacity of your vehicle.

Metric Example For Load Limit

For example, if "XXX" amount equals 635 kg and there will be five 68 kg passengers in your vehicle, the amount of available cargo and luggage load capacity is 295 kg $(635 - 340 (5 \times 68) = 295 \text{ kg})$ as shown in step 4.

NOTE:

- If your vehicle will be towing a trailer, load from your trailer will be transferred to your vehicle. The following table shows examples on how to calculate total load, cargo/luggage, and towing capacities of your vehicle with varying seating configurations and number and size of occupants. This table is for illustration purposes only and may not be accurate for the seating and load carry capacity of your vehicle.
- For the following example, the combined weight of occupants and cargo should never exceed 865 lbs (392 kg).

Occupants			Combined weight of occupants and cargo from Tire Placard	MINUS	Combined Occupant's weight	=	AVAILABLE Cargo/Luggage and Trailer Tongue Weight
TOTAL	FRONT	REAR					
<u>EXAMPLE 1</u>			↓ 865 lbs	minus	Occupant 1: 200 lbs Occupant 2: 130 lbs Occupant 3: 160 lbs Occupant 4: 100 lbs Occupant 5: 80 lbs TOTAL WEIGHT: 670 lbs	=	↓ 195 lbs
5	2	3					
<u>EXAMPLE 2</u>			865 lbs	minus	Occupant 1: 210 lbs Occupant 2: 180 lbs Occupant 3: 150 lbs TOTAL WEIGHT: 540 lbs	=	325 lbs
3	2	1					
<u>EXAMPLE 3</u>			865 lbs	minus	Occupant 1: 200 lbs Occupant 2: 200 lbs TOTAL WEIGHT: 400 lbs	=	465 lbs
2	2	0					

EXAMPLE

WARNING!

Overloading of your tires is dangerous. Overloading can cause tire failure, affect vehicle handling, and increase your stopping distance. Use tires of the recommended load capacity for your vehicle. Never overload them.

TIRES — GENERAL INFORMATION

Tire Pressure

Proper tire inflation pressure is essential to the safe and satisfactory operation of your vehicle. Four primary areas are affected by improper tire pressure:

- Safety
- Fuel Economy

- Tread Wear
- Ride Comfort and Vehicle Stability

Safety

WARNING!

- Improperly inflated tires are dangerous and can cause collisions.

(Continued)

WARNING!

- Underinflation increases tire flexing and can result in overheating and tire failure.
- Overinflation reduces a tire's ability to cushion shock. Objects on the road and chuckholes can cause damage that result in tire failure.
- Overinflated or underinflated tires can affect vehicle handling and can fail suddenly, resulting in loss of vehicle control.
- Unequal tire pressures can cause steering problems. You could lose control of your vehicle.
- Unequal tire pressures from one side of the vehicle to the other can cause the vehicle to drift to the right or left.
- Always drive with each tire inflated to the recommended cold tire inflation pressure.

Both underinflation and overinflation affect the stability of the vehicle and can produce a feeling of sluggish response or over responsiveness in the steering.

NOTE:

- Unequal tire pressures from side to side may cause erratic and unpredictable steering response.
- Unequal tire pressure from side to side may cause the vehicle to drift left or right.

Fuel Economy

Underinflated tires will increase tire rolling resistance resulting in higher fuel consumption.

Tread Wear

Improper cold tire inflation pressures can cause abnormal wear patterns and reduced tread life, resulting in the need for earlier tire replacement.

Ride Comfort And Vehicle Stability

Proper tire inflation contributes to a comfortable ride. Overinflation produces a jarring and uncomfortable ride.

Tire Inflation Pressures

The proper cold tire inflation pressure is listed on the driver's side B-pillar or rear edge of the driver's side door.

At least once a month:

- Check and adjust tire pressure with a good quality pocket-type pressure gauge. Do not make a visual judgment when determining proper inflation. Tires may look properly inflated even when they are underinflated.
- Inspect tires for signs of tire wear or visible damage.

CAUTION!

After inspecting or adjusting the tire pressure, always reinstall the valve stem cap. This will prevent moisture and dirt from entering the valve stem, which could damage the valve stem.

Inflation pressures specified on the placard are always "cold tire inflation pressure". Cold tire inflation pressure is defined as the tire pressure after the vehicle has not been driven for at least three hours, or driven less than 1 mile (1.6 km) after sitting for a minimum of three

hours. The cold tire inflation pressure must not exceed the maximum inflation pressure molded into the tire sidewall.

Check tire pressures more often if subject to a wide range of outdoor temperatures, as tire pressures vary with temperature changes.

Tire pressures change by approximately 1 psi (7 kPa) per 12° F (7° C) of air temperature change. Keep this in mind when checking tire pressure inside a garage, especially in the Winter.

Example: If garage temperature = 68° F (20° C) and the outside temperature = 32° F (0° C) then the cold tire inflation pressure should be increased by 3 psi (21 kPa), which equals 1 psi (7 kPa) for every 12° F (7° C) for this outside temperature condition.

Tire pressure may increase from 2 to 6 psi (13 to 40 kPa) during operation. DO NOT reduce this normal pressure build up or your tire pressure will be too low.

Tire Pressures For High Speed Operation

The manufacturer advocates driving at safe speeds and within posted speed limits. Where speed limits or conditions are such that the vehicle can be driven at high speeds, maintaining correct tire inflation pressure is very important. Increased tire pressure and reduced vehicle loading may be required for high-speed vehicle operation. Refer to an authorized tire dealer or original equipment vehicle dealer for recommended safe operating speeds, loading and cold tire inflation pressures.

WARNING!

High speed driving with your vehicle under maximum load is dangerous. The added strain on your tires could cause them to fail. You could have a serious collision. Do not drive a vehicle loaded to the maximum capacity at continuous speeds above 75 mph (120 km/h).

Radial Ply Tires

WARNING!

Combining radial ply tires with other types of tires on your vehicle will cause your vehicle to handle poorly. The instability could cause a collision. Always use radial ply tires in sets of four. Never combine them with other types of tires.

Tire Repair

If your tire becomes damaged, it may be repaired if it meets the following criteria:

- The tire has not been driven on when flat
- The damage is only on the tread section of your tire (sidewall damage is not repairable)
- The puncture is no greater than $\frac{1}{4}$ of an inch (6 mm)

Consult an authorized tire dealer for tire repairs and additional information.

Damaged Run Flat tires, or Run Flat tires that have experienced a loss of pressure should be replaced immediately with another Run Flat tire of identical size and service description (Load Index and Speed

Symbol). Replace the tire pressure sensor as well as it is not designed to be reused.

Run Flat Tires – If Equipped

Run Flat tires allow you the capability to drive 50 miles (80 km) at 50 mph (80 km/h) after a rapid loss of inflation pressure. This rapid loss of inflation is referred to as the Run Flat mode. A Run Flat mode occurs when the tire inflation pressure is of/or below 14 psi (96 kPa). Once a Run Flat tire reaches the Run Flat mode it has limited driving capabilities and needs to be replaced immediately. A Run Flat tire is not repairable. When a Run Flat tire is changed after being driven in a Run Flat mode 14 psi (96 kPa) condition, please replace the TPMS sensor as it is not designed to be reused.

NOTE:

The TPMS Sensor must be replaced after driving the vehicle on a flat tire condition.

It is not recommended driving a vehicle loaded at full capacity or to tow a trailer while a tire is in the Run Flat mode.

For more information ⇨ page 297.

Tire Spinning

When stuck in mud, sand, snow, or ice conditions, do not spin your vehicle's wheels above 30 mph (48 km/h) or for longer than 30 seconds continuously without stopping.

For further information ⇨ page 346.

WARNING!

Fast spinning tires can be dangerous. Forces generated by excessive wheel speeds may cause tire damage or failure. A tire could explode and injure someone. Do not spin your vehicle's wheels faster than 30 mph (48 km/h) for more than 30 seconds continuously when you are stuck, and do not let anyone near a spinning wheel, no matter what the speed.

Tread Wear Indicators

Tread wear indicators are in the original equipment tires to help you in determining when your tires should be replaced.

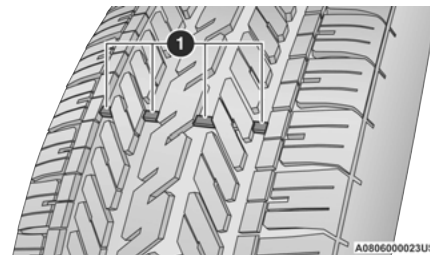
**Tire Tread**

1 – Tread Wear Indicators

These indicators are molded into the bottom of the tread grooves. They will appear as bands when the tread depth becomes $\frac{1}{16}$ of an inch (1.6 mm). When

the tread is worn to the tread wear indicators, the tire should be replaced.

For further information ⇨ page 400.

Life Of Tire

The service life of a tire is dependent upon varying factors including, but not limited to:

- Driving style
- Tire pressure - Improper cold tire inflation pressures can cause uneven wear patterns to develop across the tire tread. These abnormal wear patterns will reduce tread life, resulting in the need for earlier tire replacement
- Distance driven
- Performance tires, tires with a speed rating of V or higher, and Summer tires typically have a reduced tread life. Rotation of these tires per the vehicle scheduled maintenance is highly recommended

WARNING!

Tires and the spare tire should be replaced after six years, regardless of the remaining tread. Failure to follow this warning can result in sudden tire failure. You could lose control and have a collision resulting in serious injury or death.

NOTE:

Wheel Valve Stem must be replaced as well when installing new tires due to wear and tear in existing tires.

Keep dismantled tires in a cool, dry place with as little exposure to light as possible. Protect tires from contact with oil, grease, and gasoline.

Replacement Tires

The tires on your new vehicle provide a balance of many characteristics. They should be inspected regularly for wear and correct cold tire inflation pressures. The manufacturer strongly recommends using tires equivalent to the originals in size, quality and performance when replacement is needed ⇨ page 399. Refer to the Tire And Loading Information Placard or the Vehicle Certification Label for the size designation of your tire. The Load Index and Speed Symbol for your tire will be found on the original equipment tire sidewall.

For more information relating to the Load Index and Speed Symbol of a tire ⇨ page 399.

It is recommended to replace the two front tires or two rear tires as a pair. Replacing just one tire can seriously affect your vehicle's handling. If you ever replace a wheel, make sure that the wheel's specifications match those of the original wheels.

It is recommended you contact an authorized tire dealer or original equipment dealer with any questions you may have on tire specifications or capability. Failure to use equivalent replacement tires may adversely affect the safety, handling, and ride of your vehicle.

WARNING!

- Do not use a tire, wheel size, load rating, or speed rating other than that specified for your vehicle. Some combinations of unapproved tires and wheels may change suspension dimensions and performance characteristics, resulting in changes to steering, handling, and braking of your vehicle. This can cause unpredictable handling and stress to steering and suspension components. You could lose control and have a collision resulting in serious injury or death. Use only the tire and wheel sizes with load ratings approved for your vehicle.
- Never use a tire with a smaller load index or capacity, other than what was originally equipped on your vehicle. Using a tire with a smaller load index could result in tire overloading and failure. You could lose control and have a collision.
- Failure to equip your vehicle with tires having adequate speed capability can result in sudden tire failure and loss of vehicle control.

CAUTION!

Replacing original tires with tires of a different size may result in false speedometer and odometer readings.

TIRE TYPES

All Season Tires – If Equipped

All Season tires provide traction for all seasons (Spring, Summer, Autumn, and Winter). Traction levels may vary between different all season tires. All season tires can

be identified by the M+S, M&S, M/S or MS designation on the tire sidewall. Use all season tires only in sets of four; failure to do so may adversely affect the safety and handling of your vehicle.

Summer Or Three Season Tires — If Equipped

Summer tires provide traction in both wet and dry conditions, and are not intended to be driven in snow or on ice. If your vehicle is equipped with Summer tires, be aware these tires are not designed for Winter or cold driving conditions. Install Winter tires on your vehicle when ambient temperatures are less than 40°F (5°C) or if roads are covered with ice or snow. For more information, contact an authorized dealer.

Summer tires do not contain the all season designation or mountain/snowflake symbol on the tire sidewall. Use Summer tires only in sets of four; failure to do so may adversely affect the safety and handling of your vehicle.

WARNING!

Do not use Summer tires in snow/ice conditions. You could lose vehicle control, resulting in severe injury or death. Driving too fast for conditions also creates the possibility of loss of vehicle control.

Snow Tires



Some areas of the country require the use of snow tires during the Winter. Snow tires can be identified by a “mountain/snowflake” symbol on the tire sidewall.

If you need snow tires, select tires equivalent in size and type to the original equipment tires. Use snow tires

only in sets of four; failure to do so may adversely affect the safety and handling of your vehicle.

Snow tires generally have lower speed ratings than what was originally equipped with your vehicle and should not be operated at sustained speeds over 75 mph (120 km/h). For speeds above 75 mph (120 km/h) refer to original equipment or an authorized tire dealer for recommended safe operating speeds, loading and cold tire inflation pressures.

While studded tires improve performance on ice, skid and traction capability on wet or dry surfaces may be poorer than that of non-studded tires. Some states prohibit studded tires; therefore, local laws should be checked before using these tire types.

SPARE TIRES — IF EQUIPPED

NOTE:

For vehicles equipped with Tire Service Kit instead of a spare tire, please refer to “Tire Service Kit” in “In Case Of Emergency” for further information.

CAUTION!

Because of the reduced ground clearance, do not take your vehicle through an automatic car wash with a compact or limited use temporary spare installed. Damage to the vehicle may result.

For restrictions when towing with a spare tire designated for temporary emergency use ➞ page 213.

Spare Tire Matching Original Equipped Tire And Wheel — If Equipped

Your vehicle may be equipped with a spare tire and wheel equivalent in look and function to the original equipment tire and wheel found on the front or rear axle of your vehicle. This spare tire may be used in the tire rotation for your vehicle. If your vehicle has this option, refer to an authorized tire dealer for the recommended tire rotation pattern.

Compact Spare Tire — If Equipped

The compact spare is for temporary emergency use only. You can identify if your vehicle is equipped with a compact spare by looking at the spare tire description on the Tire And Loading Information Placard located on the driver’s side door opening or on the sidewall of the tire. Compact spare tire descriptions begin with the letter “T” or “S” preceding the size designation. Example: T145/80D18 103M.

T, S = Temporary Spare Tire

Since this tire has limited tread life, the original equipment tire should be repaired (or replaced) and reinstalled on your vehicle at the first opportunity.

Do not install a wheel cover or attempt to mount a conventional tire on the compact spare wheel, since the wheel is designed specifically for the compact spare tire. Do not install more than one compact spare tire and wheel on the vehicle at any given time.

WARNING!

Compact and collapsible spares are for temporary emergency use only. With these spares, do not drive more than 50 mph (80 km/h). Temporary use spares have limited tread life. When the tread is worn to the tread wear indicators, the temporary use spare tire needs to be replaced. Be sure to follow the warnings, which apply to your spare. Failure to do so could result in spare tire failure and loss of vehicle control.

Collapsible Spare Tire — If Equipped

The collapsible spare is for temporary emergency use only. You can identify if your vehicle is equipped with a collapsible spare by looking at the spare tire description on the Tire And Loading Information Placard located on the driver's side door opening or on the sidewall of the tire.

Collapsible spare tire description example: 165/80-17 101P.

Since this tire has limited tread life, the original equipment tire should be repaired (or replaced) and reinstalled on your vehicle at the first opportunity.

Inflate collapsible tire only after the wheel is properly installed to the vehicle. Inflate the collapsible tire using the electric air pump before lowering the vehicle.

Do not install a wheel cover or attempt to mount a conventional tire on the collapsible spare wheel, since the wheel is designed specifically for the collapsible spare tire.

WARNING!

Compact and Collapsible spares are for temporary emergency use only. With these spares, do not drive more than 50 mph (80 km/h). Temporary use spares have limited tread life. When the tread is worn to the tread wear indicators, the temporary use spare tire needs to be replaced. Be sure to follow the warnings, which apply to your spare. Failure to do so could result in spare tire failure and loss of vehicle control.

Full Size Spare — If Equipped

The full size spare is for temporary emergency use only. This tire may look like the originally equipped tire on the front or rear axle of your vehicle, but it is not. This spare tire may have limited tread life. When the tread is worn to the tread wear indicators, the temporary use full size spare tire needs to be replaced. Since it is not the same as your original equipment tire, replace (or repair) the original equipment tire and reinstall on the vehicle at the first opportunity.

Limited Use Spare — If Equipped

The limited use spare tire is for temporary emergency use only. This tire is identified by a label located on the limited use spare wheel. This label contains the driving limitations for this spare. This tire may look like the original equipped tire on the front or rear axle of your vehicle, but it is not. Installation of this limited use spare tire affects vehicle handling. Since it is not the same as your original equipment tire, replace (or repair) the original equipment tire and reinstall on the vehicle at the first opportunity.

WARNING!

Limited use spares are for emergency use only. Installation of this limited use spare tire affects vehicle handling. With this tire, do not drive more than the speed listed on the limited use spare wheel. Keep inflated to the cold tire inflation pressures listed on your Tire And Loading Information Placard located on the driver's side B-pillar or the rear edge of the driver's side door. Replace (or repair) the original equipment tire at the first opportunity and reinstall it on your vehicle. Failure to do so could result in loss of vehicle control.

WHEEL AND WHEEL TRIM CARE

All wheels and wheel trim, especially aluminum and chrome plated wheels, should be cleaned regularly using mild (neutral Ph) soap and water to maintain their luster and to prevent corrosion. Wash wheels with the same soap solution recommended for the body of the vehicle and remember to always wash when the surfaces are not hot to the touch.

Your wheels are susceptible to deterioration caused by salt, sodium chloride, magnesium chloride, calcium chloride, etc., and other road chemicals used to melt ice or control dust on dirt roads. Use a soft cloth or sponge and mild soap to wipe away promptly. Do not use harsh chemicals or a stiff brush. They can damage the wheel's protective coating that helps keep them from corroding and tarnishing.

CAUTION!

Avoid products or automatic car washes that use acidic solutions or strong alkaline additives or harsh brushes. Many aftermarket wheel cleaners and automatic car washes may damage the wheel's protective finish. Such damage is not covered by the New Vehicle Limited Warranty. Only car wash soap, Mopar® Wheel Cleaner or equivalent is recommended.

When cleaning extremely dirty wheels including excessive brake dust, care must be taken in the selection of tire and wheel cleaning chemicals and equipment to prevent damage to the wheels. Mopar® Wheel Treatment or Mopar® Chrome Cleaner or their equivalent is recommended or select a non-abrasive, non-acidic cleaner for aluminum or chrome wheels.

CAUTION!

Do not use scouring pads, steel wool, a bristle brush, metal polishes or oven cleaner. These products may

(Continued)

CAUTION!

damage the wheel's protective finish. Such damage is not covered by the New Vehicle Limited Warranty. Only car wash soap, Mopar® Wheel Cleaner or equivalent is recommended.

NOTE:

If you intend parking or storing your vehicle for an extended period after cleaning the wheels with wheel cleaner, drive your vehicle and apply the brakes to remove the water droplets from the brake components. This activity will remove the red rust on the brake rotors and prevent vehicle vibration when braking.

Dark Vapor Chrome, Black Satin Chrome, or Low Gloss Clear Coat Wheels
CAUTION!

If your vehicle is equipped with these specialty wheels, DO NOT USE wheel cleaners, abrasives, or polishing compounds. They will permanently damage this finish and such damage is not covered by the

(Continued)

CAUTION!

New Vehicle Limited Warranty. **HAND WASH ONLY USING MILD SOAP AND WATER WITH A SOFT CLOTH.** Used on a regular basis; this is all that is required to maintain this finish.

SNOW TRACTION DEVICES

Use of traction devices require sufficient tire-to-body clearance. Due to limited clearance, the following snow traction devices are recommended. Follow these recommendations to guard against damage:

- Snow traction device must be of proper size for the tire, as recommended by the snow traction device manufacturer.
- No other tire sizes are recommended for use with the snow traction device.
- Please follow the table for the recommended tire size, axle and snow traction device:

4x2 (2WD) Trim Level	Axle	Tire/Wheel Size	Snow Traction Device (Maximum Projection Beyond Tire Profile Or Equivalent)
HFE Tradesman Bighorn Lonestar Laramie	Rear	275/65R18 275/55R20	S Class

4x2 (2WD) Trim Level	Axle	Tire/Wheel Size	Snow Traction Device (Maximum Projection Beyond Tire Profile Or Equivalent)
Longhorn Sport Limited	Rear	275/55R20	S Class
REBEL	Not Chainable		

4x4 (4WD) Trim Level	Axle	Tire/Wheel Size	Snow Traction Device (Maximum Projection Beyond Tire Profile Or Equivalent)
Tradesman Bighorn Lonestar Laramie	Rear	275/65R18 275/55R20	S Class
Longhorn Sport Limited	Rear	275/55R20	S Class
REBEL	Not Chainable		
RHO	Not Chainable		

WARNING!

Using tires of different size and type (M+S, Snow) between front and rear axles can cause unpredictable handling. You could lose control and have a collision.

CAUTION!

To avoid damage to your vehicle or tires, observe the following precautions:

- Because of restricted traction device clearance between tires and other suspension components, it is important that only traction devices in good condition are used. Broken devices can cause serious damage. Stop the vehicle immediately if noise occurs that could indicate device breakage. Remove the damaged parts of the device before further use.
- Install device as tightly as possible and then retighten after driving about ½ mile (0.8 km). Autosock traction devices do not require retightening.
- Do not exceed 30 mph (48 km/h).
- Drive cautiously and avoid severe turns and large bumps, especially with a loaded vehicle.
- Do not drive for a prolonged period on dry pavement.
- Observe the traction device manufacturer's instructions on the method of installation, operating speed, and conditions for use. Always use the suggested operating speed of the device manufacturer's if it is less than 30 mph (48 km/h).
- Do not use traction devices on a compact spare tire.

TIRE ROTATION RECOMMENDATIONS

Tires on the front and rear axles of vehicles operate at different loads and perform different steering, driving, and braking functions. For these reasons, they wear at unequal rates.

These effects can be reduced by timely rotation of tires. The benefits of rotation are especially worthwhile with aggressive tread designs such as those on all season type tires. Rotation will increase tread life, help to maintain mud, snow and wet traction levels and contribute to a smooth, quiet ride.

For the proper maintenance intervals ⇨ page 349. More frequent rotation is permissible if desired. The reasons for any rapid or unusual wear should be corrected prior to rotation being performed.

The suggested rotation method is the "rearward cross" shown in the following diagram. This rotation pattern does not apply to some directional tires that must not be reversed.

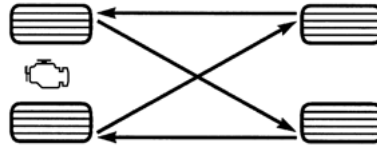

Tire Rotation (Rearward Cross)

055703771

**DEPARTMENT OF TRANSPORTATION
UNIFORM TIRE QUALITY GRADES**

The following tire grading categories were established by the National Highway Traffic Safety Administration. The specific grade rating assigned by the tire's manufacturer in each category is shown on the sidewall of the tires on your vehicle.

All passenger vehicle tires must conform to Federal safety requirements in addition to these grades.

TREADWEAR

The Treadwear grade is a comparative rating, based on the wear rate of the tire when tested under controlled conditions on a specified government test course. For example, a tire graded 150 would wear one and one-half times as well on the government course as a tire graded

100. The relative performance of tires depends upon the actual conditions of their use, however, and may depart significantly from the norm due to variations in driving habits, service practices, and differences in road characteristics and climate.

TRACTION GRADES

The Traction grades, from highest to lowest, are AA, A, B, and C. These grades represent the tire's ability to stop on wet pavement, as measured under controlled conditions on specified government test surfaces of asphalt and concrete. A tire marked C may have poor traction performance.

WARNING!

The traction grade assigned to this tire is based on straight-ahead braking traction tests, and does not include acceleration, cornering, hydroplaning, or peak traction characteristics.

TEMPERATURE GRADES

The Temperature grades are A (the highest), B, and C, representing the tire's resistance to the generation of heat and its ability to dissipate heat, when tested under controlled conditions on a specified indoor laboratory test wheel.

Sustained high temperature can cause the material of the tire to degenerate and reduce tire life, and excessive temperature can lead to sudden tire failure. The grade C corresponds to a level of performance, which all passenger vehicle tires must meet under the Federal Motor Vehicle Safety Standard No. 109. Grades B and A represent higher levels of performance on the laboratory test wheel, than the minimum required by law.

WARNING!

The temperature grade for this tire is established for a tire that is properly inflated and not overloaded. Excessive speed, underinflation, or excessive loading, either separately or in combination, can cause heat buildup and possible tire failure.

STORING THE VEHICLE

If you are storing your vehicle for more than three weeks, we recommend that you take the following steps to minimize the drain on your vehicle's battery:

- Disconnect the negative cable from battery.
- Any time you store your vehicle or keep it out of service (i.e., vacation) for two weeks or more, run the air conditioning system at idle for about five minutes in the fresh air and high blower setting. This will ensure adequate system lubrication to minimize the possibility of compressor damage when the system is started again.

BATTERY STORAGE MODE — RHO

With the ignition in the ON position, engine not running, navigate to the battery gauge page on the instrument cluster display, then press and hold the OK button. The vehicle will be put into battery storage mode, which will greatly increase the amount of time the vehicle can sit and restart without needing to disconnect the battery. Going into battery storage mode will increase the amount of time between starts to about 60 days.

NOTE:

The key fob buttons will not work while the vehicle is in battery storage mode. Pulling the door handle will wake the vehicle and allow it to recognize the key fob to unlock the door.

BODYWORK**PROTECTION FROM ATMOSPHERIC AGENTS**

Vehicle body care requirements vary according to geographic locations and usage. Chemicals that make roads passable in snow and ice and those that are sprayed on trees and road surfaces during other seasons are highly corrosive to the metal in your vehicle. Outside parking, which exposes your vehicle to airborne contaminants, road surfaces on which the vehicle is operated, extreme hot or cold weather and other extreme conditions will have an adverse effect on paint, metal trim, and underbody protection.

The following maintenance recommendations will enable you to obtain maximum benefit from the corrosion resistance built into your vehicle.

What Causes Corrosion?

Corrosion is the result of deterioration or removal of paint and protective coatings from your vehicle.

The most common causes are:

- Road salt, dirt and moisture accumulation.
- Stone and gravel impact.
- Insects, tree sap and tar.

- Salt in the air near seacoast localities.
- Atmospheric fallout/industrial pollutants.

BODY AND UNDERBODY MAINTENANCE**Cleaning Headlights**

Your vehicle is equipped with plastic headlights and fog lights that are lighter and less susceptible to stone breakage than glass headlights.

Plastic is not as scratch resistant as glass and therefore different lens cleaning procedures must be followed.

To minimize the possibility of scratching the lenses and reducing light output, avoid wiping with a dry cloth. To remove road dirt, wash with a mild soap solution followed by rinsing.

Do not use abrasive cleaning components, solvents, steel wool or other aggressive material to clean the lenses.

Tri-Fold Soft Tonneau Cover Care

For cleaning and protecting the vinyl Tri-Fold Tonneau cover, use Mopar® Whitewall & Vinyl Top Cleaner and Mopar® Leather and Vinyl Conditioner/Protectant.

PRESERVING THE BODYWORK**Washing**

- Wash your vehicle regularly. Always wash your vehicle in the shade using Mopar® Car Wash, or a mild car wash soap, and rinse the panels completely with water.

- If insects, tar, or other similar deposits have accumulated on your vehicle, use Mopar® Super Kleen Bug and Tar Remover to remove.
- Use a high quality cleaner wax, such as Mopar® Cleaner Wax to remove road film, stains and to protect your paint finish. Use precautions to not scratch the paint.
- Avoid using abrasive compounds and power buffing that may diminish the gloss or thin out the paint finish.

CAUTION!

- Do not use abrasive or strong cleaning materials such as steel wool or scouring powder that will scratch metal and painted surfaces.
- Use of power washers exceeding 1,200 psi (8,274 kPa) can result in damage or removal of paint and decals.

Fascia/Bumper Care

The customer is responsible to clean and maintain the chrome components of the vehicle. Wash away road debris and salt using an automotive soap. Fascia/bumpers should be cleaned regularly using mild (neutral Ph) soap and water to maintain their luster and to prevent corrosion.

Your fascia/bumpers are susceptible to deterioration caused by salt, sodium chloride, magnesium chloride, calcium chloride, etc., and other road chemicals used to melt ice or control dust on dirt roads. Do not use harsh chemicals or a stiff brush. They can stain or

damage the protective coating that helps keep them from corroding and tarnishing.

CAUTION!

- Do not use scouring pads, steel wool, a bristle brush, metal polishes, or oven cleaner. These products may damage the bumper's protective finish. Such damage is not covered by the New Vehicle Limited Warranty. Only car wash soap, Mopar® Chrome Cleaner, or equivalent is recommended.
- Avoid products or automatic car washes that use acidic solutions, strong alkaline additives, or harsh brushes. Many aftermarket cleaners and automatic car washes may damage the bumper's protective finish. Such damage is not covered by the New Vehicle Limited Warranty. Only car wash soap, Mopar® Chrome Cleaner, or equivalent is recommended.

Special Care

- If you drive on salted or dusty roads or if you drive near the ocean, hose off the undercarriage at least once a month.
- It is important that the drain holes in the lower edges of the doors, rocker panels, and trunk be kept clear and open.
- If you detect any stone chips or scratches in the paint, touch them up immediately.
- If your vehicle is damaged due to a collision or similar cause that destroys the paint and protective

coating, have your vehicle repaired as soon as possible.

- If you carry special cargo such as chemicals, fertilizers, de-icer salt, etc., be sure that such materials are well packaged and sealed.
- If a lot of driving is done on gravel roads, consider mud or stone shields behind each wheel.
- Use Mopar® Touch Up Paint on scratches as soon as possible. An authorized dealer has touch up paint to match the color of your vehicle.

Spray-On Bedliner – If Equipped

During ownership, the shine and luster of the Spray-On Bedliner can fade from oxidation, road dirt, heavy-duty hauling and hard water stains. Weathering and UV exposure will lead to fading.

To help maintain the appearance of your Spray-On Bedliner, the manufacturer recommends you periodically rinse all loose dirt from your truck bed and clean your truck at least twice per year using the Mopar® Spray-On Bedliner Conditioner available at a local authorized dealer.

To Help Maintain The Appearance Of Your Spray-On Bedliner

1. Rinse your truck bed out with water to remove any loose dirt and debris.
2. Mix a mild soap or detergent with water. Then apply solution with a soft cloth or brush.
3. Rinse bedliner with water.
4. Once dry, apply a small amount of Mopar® Spray-On Bedliner Conditioner to a moist towel or sponge

and wipe over the entire surface of the truck bedliner.

WARNING!

Do not use silicon-based protection products to clean your bedliner. Silicon-based products can become slippery and may result in personal injury.

Spray-On Bedliners are chemically-resistant to many different types of chemicals (including gasoline, oil, hydraulic fluids) for short periods of time. If a spill occurs on your Spray-On Bedliner, rinse the truck out as soon as possible to avoid permanent damage.

Repairing The Spray-On Bedliner

While extremely tough, it is possible to damage a Spray-On Bedliner. One common condition is when loading a heavy pallet and dragging that pallet across the floor of the bed. If a nail or sharp point is exposed under the weight of the pallet a scratch or tear is possible. While not covered by your new vehicle warranty, a cosmetic fix to cover the metal exposed by the scratch is required. To repair a tear or gouge, follow the directions provided in the Mopar® Quick Repair Kit.

INTERIORS

SEATS AND FABRIC PARTS

Use Mopar® Total Clean to clean fabric upholstery and carpeting.

WARNING!

Do not use volatile solvents for cleaning purposes. Many are potentially flammable, and if used in closed areas they may cause respiratory harm.

Stain Repel Fabric Cleaning Procedure – If Equipped

Stain Repel seats may be cleaned in the following manner:

- Remove as much of the stain as possible by blotting with a clean, dry towel.
- Blot any remaining stain with a clean, damp towel.
- For tough stains, apply Mopar® Total Clean, or a mild soap solution to a clean, damp cloth and remove stain. Use a fresh, damp towel to remove soap residue.
- For grease stains, apply Mopar® Multi-Purpose Cleaner to a clean, damp cloth and remove stain. Use a fresh, damp towel to remove soap residue.
- Do not use any harsh solvents or any other form of protectants on Stain Repel products.

Suede Steering Wheel Cleaning – RHO

It is sufficient to dust the steering wheel using a soft bristle brush, a dry cloth, or a vacuum cleaner with care. After having dusted, run a white cotton terry cloth that has been dampened and thoroughly wrung out over the steering wheel. Avoid the use of printed absorbent cloths/papers, as they can release ink into the material. Take extra care not to wet the steering

wheel excessively; rinse the cloth or sponge and repeat as necessary. Leave to dry (overnight). Once dried, in order to restore the material, brush it delicately with a soft bristle brush.

Seat Belt Maintenance

Do not bleach, dye or clean the belts with chemical solvents or abrasive cleaners. This will weaken the fabric.

If the belts need cleaning, use a mild soap solution or lukewarm water. Do not remove the belts from the vehicle to wash them. Dry with a soft cloth.

Sun damage can also weaken the fabric. Replace the belts if they appear frayed or worn or if the buckles do not work properly.

NOTE:

If the belts retract slowly, inspect the upper turning loop for soiling. If soiling is present, clean with a wet soft cloth until all residue is removed.

WARNING!

A frayed or torn seat belt could rip apart in a collision and leave you with no protection. Inspect the seat belt system periodically, checking for cuts, frays, or loose parts. Damaged parts must be replaced immediately. Do not disassemble or modify the seat belt system. If your vehicle is involved in a collision, or if you have questions regarding seat belt or retractor conditions, take your vehicle to an authorized FCA dealer or authorized FCA Certified Collision Care Program facility for inspection.

PLASTIC AND COATED PARTS

Use Mopar® Total Clean to clean vinyl upholstery.

CAUTION!

- Direct contact of air fresheners, insect repellents, suntan lotions, or hand sanitizers to the plastic, painted, or decorated surfaces of the interior may cause permanent damage. Wipe away immediately.
- Damage caused by these type of products may not be covered by your New Vehicle Limited Warranty.

Cleaning Plastic Instrument Cluster Lenses

The lenses in front of the instruments in this vehicle are molded in clear plastic. When cleaning the lenses, care must be taken to avoid scratching the plastic.

Clean with a wet soft cloth. A mild soap solution may be used, but do not use high alcohol content or abrasive cleaners. If soap is used, wipe clean with a clean damp cloth. Dry with a soft cloth.

LEATHER SURFACES

Mopar® Total Clean is specifically recommended for leather upholstery.

Your leather upholstery can be best preserved by regular cleaning with a damp soft cloth. Small particles of dirt can act as an abrasive and damage the leather upholstery and should be removed promptly with a damp cloth. Stubborn soils can be removed easily with a soft cloth and Mopar® Total Clean. Care should be

taken to avoid soaking your leather upholstery with any liquid. Please do not use polishes, oils, cleaning fluids, solvents, detergents, or ammonia-based cleaners to clean your leather upholstery.

NOTE:

If equipped with light colored leather, it tends to show any foreign material, dirt, and fabric dye transfer more so than darker colors. The leather is designed for easy cleaning, and the manufacturer recommends Mopar® Total Clean leather cleaner applied on a cloth to clean the leather seats as needed.

CAUTION!
Do not use alcohol and alcohol-based and/or ketone-based cleaning products to clean leather upholstery, as damage to the upholstery may result.

GLASS SURFACES

All glass surfaces should be cleaned on a regular basis with Mopar® Glass Cleaner, or any commercial household-type glass cleaner. Never use an abrasive type cleaner. Use caution when cleaning the inside rear window equipped with electric defrosters or windows equipped with radio antennas. Do not use scrapers or other sharp instruments that may scratch the elements.

When cleaning the rearview mirror, spray cleaner on the towel or cloth that you are using. Do not spray cleaner directly on the mirror.

TECHNICAL SPECIFICATIONS

VEHICLE IDENTIFICATION NUMBER (VIN)

The VIN is found on the left front corner of the instrument panel, visible through the windshield.

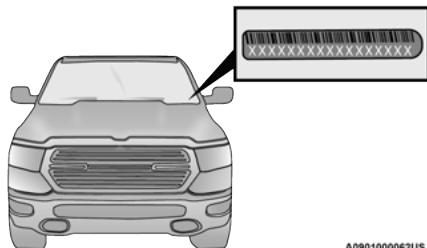

A0901000062US

Vehicle Identification Number

NOTE:

It is illegal to remove or alter the VIN.

BRAKE SYSTEM

If power assist is lost for any reason (for example, repeated brake applications with the engine off), the brakes will still function. However, you will experience a substantial increase in braking effort to stop the vehicle.

If either the front or rear hydraulic systems lose normal braking capability, the remaining system will

still function with some loss of overall braking effectiveness. This will be evident by increased pedal travel during application, greater pedal force required to slow or stop, and the Brake Warning Light and the Anti-Lock Brake System (ABS) Warning Light will activate during brake use.

WHEEL AND TIRE TORQUE SPECIFICATIONS

Proper lug nut/bolt torque is very important to ensure that the wheel is properly mounted to the vehicle. Any time a wheel has been removed and reinstalled on the vehicle, the lug nuts/bolts should be torqued using a properly calibrated torque wrench using a six-sided (hex) deep wall socket.

TORQUE SPECIFICATIONS

Lug Nut/ Bolt Torque	Lug Nut/ Bolt Type	**Lug Nut/ Bolt Size	Lug Nut/ Bolt Socket Size
130 ft-lb (176 Nm)	Cone	M14 x 1.50	22 mm

**Use only authorized dealer recommended lug nuts/bolts and clean or remove any dirt or oil before tightening.

NOTE:

Do not oil wheel studs. For chrome wheels, do not substitute with chrome plated wheel nuts.

Inspect the wheel mounting surface prior to mounting the tire and remove any corrosion or loose particles.

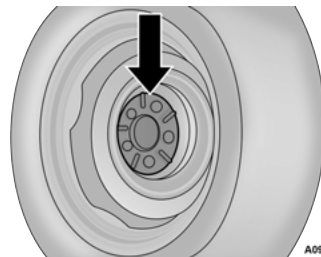

A091000006US

Wheel Mounting Surface

Tighten the lug nuts/bolts in a star pattern until each nut/bolt has been tightened twice. Ensure that the socket is fully engaged on the lug nut/bolt (do not insert it halfway).

After 25 miles (40 km), check the lug nut/bolt torque to be sure that all the lug nuts/bolts are properly seated against the wheel.

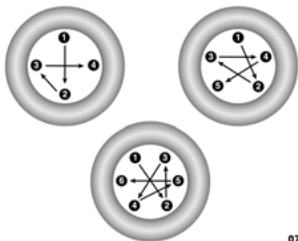

0706125609US

Four, Five, And Six Lug Nuts/Bolts Torque Patterns

WARNING!

To avoid the risk of forcing the vehicle off the jack, do not tighten the lug nuts/bolts fully until the vehicle has been lowered. Failure to follow this warning may result in personal injury.

FUEL REQUIREMENTS

While operating on gasoline with the required octane number, hearing a light knocking sound from the engine is not a cause for concern. However, if the engine is heard making a heavy knocking sound, see a dealer immediately. Use of gasoline with a lower than recommended octane number can cause engine failure and may void or not be covered by the New Vehicle Limited Warranty.

Poor quality gasoline can cause problems such as hard starting, stalling, and hesitations. If you experience these symptoms, try another brand of gasoline before considering service for the vehicle.

3.0L STANDARD OUTPUT ENGINE

Do not use E-85 flex fuel or ethanol blends greater than 15% in this engine.

This engine is designed to meet all emissions requirements, and provide satisfactory fuel economy and performance, when using high-quality unleaded regular gasoline having an octane rating of 87, as specified by the (R+M)/2 method. The use of 91 or higher octane premium gasoline will allow these engines to operate to optimal performance. This increase in performance is most noticeable in hot weather or under heavy load conditions such as while towing.

3.0L HIGH OUTPUT ENGINE — RHO

Do not use E-85 flex fuel or ethanol blends greater than 15% in this engine.

This engine is designed to meet all emission regulations, provide optimal fuel economy and performance when using high-quality unleaded premium gasoline having a posted octane number of 91 as specified by the (R+M)/2 method. The use of 91 or higher octane premium gasoline is required in this engine.

3.6L ENGINE

Do not use E-85 flex fuel or ethanol blends greater than 15% in this engine.

This engine is designed to meet all emissions regulations and provide optimum fuel economy and performance when using high quality unleaded regular gasoline

having a posted octane number of 87 as specified by the (R+M)/2 method. The use of higher octane premium gasoline is not required, as it will not provide any benefit over regular gasoline in these engines.

CLEAN AIR GASOLINE

Many gasolines are now being blended to contribute to cleaner air, especially in those areas where air pollution levels are high. These new blends provide a cleaner-burning fuel and some are referred to as "reformulated gasoline."

The manufacturer supports these efforts toward cleaner air. You can help by using these blends as they become available.

REFORMULATED GASOLINE

Many areas of the country require the use of cleaner-burning gasoline referred to as "reformulated gasoline". Reformulated gasoline contains oxygenates and are specifically blended to reduce vehicle emissions and improve air quality.

The use of reformulated gasoline is recommended. Properly blended reformulated gasoline will provide improved performance and durability of engine and fuel system components.

MATERIALS ADDED TO FUEL

Besides using unleaded gasoline with the proper octane rating, gasolines that contain detergents, corrosion and stability additives are recommended. Using gasolines that have these additives will help improve fuel economy, reduce emissions, and maintain vehicle performance.



Designated TOP TIER Detergent Gasoline contains a higher level of detergents to further aid in minimizing engine and fuel system deposits. When available, the usage of TOP TIER Detergent Gasoline is recommended. Visit www.toptiergas.com for a list of TOP TIER Detergent Gasoline retailers.

Indiscriminate use of fuel system cleaning agents should be avoided. Many of these materials intended for gum and varnish removal may contain active solvents or similar ingredients. These can harm fuel system gasket and diaphragm materials.

GASOLINE/OXYGENATE BLENDS

Some fuel suppliers blend unleaded gasoline with oxygenates such as ethanol.

CAUTION!

DO NOT use E-85, gasoline containing methanol, or gasoline containing more than 15% ethanol (E-15). Use of these blends may result in starting and drivability problems, damage critical fuel system components, cause emissions to exceed the applicable standard, and/or cause the Malfunction Indicator Light to illuminate. Please observe pump labels as they should clearly communicate if a fuel contains greater than 15% ethanol (E-15).

Problems that result from using gasoline containing more than 15% ethanol (E-15) or gasoline containing methanol are not the responsibility of the manufacturer and may void the New Vehicle Limited Warranty.

DO NOT USE E-85 IN NON-FLEX FUEL VEHICLES

Non-Flex Fuel Vehicles (FFV) are compatible with gasoline containing up to 15% ethanol (E-15). Use of gasoline with higher ethanol content may void the New Vehicle Limited Warranty.

If a Non-FFV vehicle is inadvertently fueled with E-85 fuel, the engine will have some or all of these symptoms:

- Operate in a lean mode.
- OBD II Malfunction Indicator Light on.
- Poor engine performance.
- Poor cold start and cold drivability.
- Increased risk for fuel system component corrosion.

COMPRESSED NATURAL GAS (CNG) AND LIQUID PROPANE (LP) FUEL SYSTEM MODIFICATIONS

Modifications that allow the engine to run on Compressed Natural Gas (CNG) or Liquid Propane (LP) may result in damage to the engine, emissions, and fuel system components. Problems that result from running CNG or LP are not the responsibility of the manufacturer and may void the New Vehicle Limited Warranty.

METHYLCYCLOPENTADIENYL MANGANESE TRICARBONYL (MMT)

MMT is a manganese-containing metallic additive that is blended into some gasolines to increase octane. Gasoline blended with MMT provides no performance advantage beyond gasoline of the same octane number without MMT. Gasoline blended with MMT reduces spark plug life and reduces emissions system performance in some vehicles. The manufacturer recommends that gasoline without MMT be used in your vehicle. The MMT content of gasoline may not be indicated on the gasoline pump; therefore, you should ask the gasoline retailer whether or not the gasoline contains MMT. MMT is prohibited in Federal and California reformulated gasoline.

FUEL SYSTEM CAUTIONS

CAUTION!

Follow these guidelines to maintain your vehicle's performance:

- The use of leaded gasoline is prohibited by Federal law. Using leaded gasoline can impair engine performance and damage the emissions control system.
- An out-of-tune engine or certain fuel or ignition malfunctions can cause the catalytic converter to overheat. If you notice a pungent burning odor or some light smoke, your engine may be out of tune or malfunctioning and may require immediate

(Continued)

CAUTION!

service. Contact an authorized dealer for service assistance.

- The use of fuel additives, which are now being sold as octane enhancers, is not

(Continued)

CAUTION!

recommended. Most of these products contain high concentrations of methanol. Fuel system damage or vehicle performance problems resulting from the use of such fuels or additives is not the responsibility of the manufacturer and

(Continued)

CAUTION!

may void or not be covered under the New Vehicle Limited Warranty.

NOTE:

Intentional tampering with the emissions control system can result in civil penalties being assessed against you.

FLUID CAPACITIES

	US	Metric
Fuel (Approximate)		
1500 Tradesman Quad/HFE Quad/Big Horn Quad Cab Models	23 gal	87 L
1500 Quad/Crew Cab Short-Bed Models	26 gal	98 L
1500 Quad/Crew Cab Long-Bed Models	33 gal	124.9 L
Engine Oil With Filter		
3.0L Engine	7.5 qt	7.1 L
3.6L Engine	5 qt	4.7 L
Cooling System		
3.0L Standard Output Engine w/Axle Oil Heater	18.49 qt	17.5 L
3.0L Standard Output and High Output (RHO) Engine	16.17 qt	15.3 L

	US	Metric
3.0L Standard Output and High Output (RHO) Intercooler	4.33 qt	4.1 L
3.6L Engine	12.8 qt	12.1 L
3.6L w/Axle Oil Heater	15.11 qt	14.3 L

ENGINE FLUIDS AND LUBRICANTS

Component	Fluid, Lubricant, or Genuine Part
Engine Coolant	We recommend using Mopar® Antifreeze/Coolant 10 Year/150,000 Mile (240,000 km) Formula OAT (Organic Additive Technology).
Engine Coolant Intercooler	We recommend using Mopar® Antifreeze/Coolant 10 Year/150,000 Mile (240,000 km) Formula OAT (Organic Additive Technology) meeting the requirements of the manufacturer Material Standard MS.90032.
Motor Generator Unit – 3.6L Engine	We recommend using Mopar® Antifreeze/Coolant 10 Year/150,000 Mile (240,000 km) Formula OAT (Organic Additive Technology).
Engine Oil – 3.0L Standard Output Engine	We recommend using Mopar® SAE 0W-20 Full Synthetic Engine Oil, which meets the requirements of the manufacturer Material Standard MS-6395. Equivalent full synthetic SAE 0W-20 engine oil can be used but must have the API Starburst trademark with a certification level of API-SP or later. API-SN+ is also acceptable.
	CAUTION!
	Usage of earlier API certification levels (such as API-SN or prior) can result in engine damage and is not covered by the New Vehicle Limited Warranty.

Component	Fluid, Lubricant, or Genuine Part
Engine Oil — 3.0L High Output (RHO) Engine	We recommend using Mopar® API Certified SAE 0W-40 Full Synthetic Engine Oil, which meets the requirements of the manufacturer Material Standard MS-A0921. Equivalent full synthetic SAE 0W-40 engine oil can be used but must have the API Donut trademark with a certification level of API-SP or later. API-SN+ is also acceptable.
	CAUTION!
	Usage of earlier API certification levels (such as API-SN or prior) can result in engine damage and is not covered by the New Vehicle Limited Warranty.
Fuel Selection — 3.0L Standard Engine	87 Octane (R+M)/2 Method, 0-15% Ethanol (Do Not Use E-85). The manufacturer recommends the use of 91 Octane or Higher (R+M)/2 Method for optimum performance.
Fuel Selection — 3.0L High Output (RHO) Engine	91 Octane or Higher (R+M)/2 Method, 0-15% Ethanol (Do Not Use E-85).
Engine Oil — 3.6L Engine	We recommend using Mopar® SAE 0W-20 Full Synthetic Engine Oil which meets the requirements of the manufacturer Material Standard MS-6395. Equivalent full synthetic SAE 0W-20 engine oil can be used but must have the API Starburst trade-mark.
Fuel Selection — 3.6L Engine	87 Octane (R+M)/2 Method, 0-15% ethanol (Do not use E-85).

CAUTION!

- Mixing of engine coolant (antifreeze) other than specified Organic Additive Technology (OAT) engine coolant (antifreeze), may result in engine damage and may decrease corrosion protection. Organic Additive Technology (OAT) engine coolant is different and should not be mixed with Hybrid Organic Additive Technology (HOAT) engine coolant (antifreeze) or any "globally compatible" coolant (antifreeze). If a non-OAT engine coolant (antifreeze) is introduced into the cooling system in an emergency, the cooling system will need to be drained, flushed, and refilled with fresh OAT coolant (conforming to MS.90032), by an authorized dealer as soon as possible.
- Do not use water alone or alcohol-based engine coolant (antifreeze) products. Do not use additional rust inhibitors or antirust products, as they may not be compatible with the radiator engine coolant and may plug the radiator.
- This vehicle has not been designed for use with propylene glycol-based engine coolant (antifreeze). Use of propylene glycol-based engine coolant (antifreeze) is not recommended.

CHASSIS FLUIDS AND LUBRICANTS

Component	Fluid, Lubricant, or Genuine Part
Automatic Transmission	Use only Mopar® ZF 8 & 9 Speed ATF Automatic Transmission Fluid, or equivalent. Failure to use the correct fluid may affect the function or performance of your transmission.
Transfer Case — 48-11 Active On-Demand 2-speed Transfer Case (w/4WD AUTO)	We recommend using Mobil Fluid LT.
Transfer Case — 48-12 Part Time 2-Speed Transfer Case (w/o 4WD AUTO)	We recommend using Shell Spirax S2 ATF A389.
Front Axle	We recommend using Mopar® GL-5 Synthetic Axle Lubricant SAE 75W-85.
C235 Rear Axle (3.21/3.55)	We recommend using Mopar® Synthetic Gear Lubricant SAE 75W-90 (MS-A0160). Limited-Slip Rear Axles require the addition of 5 oz. (148 ml) Mopar® Limited Slip Additive (MS-10111).
C235 Rear Axle (3.92)	We recommend using Mopar® Synthetic Gear Lubricant SAE 75W-140 (MS-8985). Limited-Slip Rear Axles require the addition of 5 oz. (148 ml) Mopar® Limited Slip Additive (MS-10111).
RB260 Rear Axle (3.92)	We recommend using Mopar® Synthetic Gear Lubricant SAE 75W-90 (MS-A0160). Limited-Slip Rear Axles require the addition of 5 oz. (148 ml) Mopar® Limited Slip Additive (MS-10111).
Brake Master Cylinder	We recommend using Mopar® DOT 3 Brake Fluid, SAE J1703.

CUSTOMER ASSISTANCE

SUGGESTIONS FOR OBTAINING SERVICE FOR YOUR VEHICLE

PREPARE FOR THE APPOINTMENT

All work to be performed may not be covered by the warranty. Discuss additional charges with the service manager. Keep a maintenance log of your vehicle's service history. This can often provide a clue to the current problem.

PREPARE A LIST

Make a written list of your vehicle's problems or the specific work you want done. If you've had an accident or work done that is not on your maintenance log, let the service advisor know.

BE REASONABLE WITH REQUESTS

If you list a number of items and you must have your vehicle by the end of the day, discuss the situation with the service advisor and list the items in order of priority. At many authorized dealers, you may obtain a rental vehicle (additional charges may apply). If you need a rental, it is advisable to make these arrangements when you call for an appointment.

IF YOU NEED ASSISTANCE

FCA US LLC and its authorized dealers are vitally interested in your satisfaction. We want you to be happy with our products and services.

Warranty service must be done by an authorized dealer. We strongly recommend that you take the vehicle to an authorized dealer. They know your vehicle the best, and are most concerned that you get prompt and high quality service. FCA US LLC's authorized dealers have the facilities, factory-trained technicians, special tools, and the latest information to ensure the vehicle is repaired correctly and in a timely manner.

This is why you should always talk to an authorized dealer's service manager first. If for some reason you are still not satisfied, talk to the general manager or owner of the authorized dealer. They want to know if you need assistance. If an authorized dealer is unable to resolve the concern, you may contact FCA US LLC's Customer Assistance center.

Any communication to FCA US LLC's customer center should include the following information:

- Owner's name and address
- Owner's telephone number (home, mobile, and office)

- Authorized dealer name
- Vehicle Identification Number (VIN)
- Vehicle delivery date and mileage

ROADSIDE ASSISTANCE

Available 24 hours, 7 days a week.

Call 1-800-521-2779 or visit chrysler.rsahelp.com(USA)

Call 1-800-363-4869 or visit fca.roadsideaid.com (Canada)

Who is Covered

You are covered by Roadside Assistance services if you are a purchaser for use of the vehicle. Roadside Assistance services last for five years or 60,000 miles for a Gas vehicle and for eight years, or 100,000 miles on the odometer for an EV, whichever occurs first. It is calculated from the start date of the Basic Limited Warranty, as set forth in your Warranty Information book.³

What to Do

If your vehicle requires jump start assistance, out of gas/fuel delivery (Gas vehicle only), tire service, lockout service, out of charge (EV) or towing as a result of a mechanical breakdown or flat tire, dial toll-free: USA: 1-800-521-2779/Canada: 1-800-363-4869.

³ Towing services provided through Cross Country Motor Club, Inc., 400 River's Edge Drive, Medford, MA 02155, except in AK, CA, HI, OR, WI, and WY, where services are provided by Cross Country Motor Club of California, Inc., 275 East Hillcrest Drive, Suite 165, Thousand Oaks, CA 91360

Provide your name, Vehicle Identification Number (VIN) required for covered services, license plate number, and your location, including the telephone number from which you are calling. Briefly describe the nature of the problem and answer a few simple questions. You will be given the name of the service provider and an estimated time of arrival. If you feel you are in an unsafe situation, please let us know. With your consent, we will contact local police or safety authorities.

If Unable to Contact Roadside Assistance

If you are unable to contact Roadside Assistance or unable to provide a valid Vehicle Identification Number (VIN), and you obtain towing services on your own, you may submit your original receipts from the licensed towing or service facility, for services rendered within 30 days of the occurrence. Be sure to include your VIN, odometer mileage at the time of service, and current mailing address. We will process the claim based on vehicle and service eligibility. If eligible, we will reimburse you for the reasonable amount actually paid, based on the usual and customary charges for that service in the area where they were provided. FCA US LLC's determination relating to reimbursement is final. Correspondence should be mailed to:

FCA US LLC Customer Assistance

P.O. Box 9145

Medford, MA 02155

Attention Claims Department

A claim can also be submitted online at <https://stellantis.roadside reimbursement.com>

FCA US LLC reserves the right to modify the terms or discontinue the Roadside Assistance Program at

any time. The Roadside Assistance program is subject to restrictions and conditions of use, which are determined solely by FCA US LLC.

Flat Tire Service

If you are inconvenienced by a flat tire, we will dispatch a service provider to use your vehicle's temporary spare tire (if equipped) as recommended in your Owner's Manual (this is not a permanent flat tire repair). If your vehicle is not equipped with a spare tire, we will tow your vehicle to the closest authorized Chrysler, Dodge, Jeep®, or Ram dealer.

Out of Gas/Fuel Delivery (Gas vehicle only)

Drivers cannot always count on a gas station being nearby, especially when traveling away from home. We will dispatch a service provider to deliver a small amount of fuel (maximum two gallons) to get you to a nearby station. This service is limited to two occurrences in a 12-month period.

Out Of Charge (EV)

With Roadside Assistance, we have you covered if your vehicle runs out of charge. Request an out of charge service and we will tow your vehicle to the nearest charging station to get you back on the road.

12V Battery Jump Assistance

No time is a good time for a depleted 12V battery. With Roadside Assistance, you do not have to worry about being stranded. We will dispatch a service provider to provide you with a battery jump anytime, day or night.

Lockout Service

Whether the keys are locked in your vehicle or frozen locks are keeping you from getting on your way, help

is just a phone call away. This service is limited to providing access to the vehicle's seating area. It does not cover the cost of replacement keys.

Towing Service

Our towing service gives you peace of mind and confidence. If your vehicle becomes disabled as a result of a mechanical breakdown, we will dispatch a towing service to transport your vehicle to the closest authorized Chrysler, Dodge, Jeep®, or Ram dealer. If you choose to go to another dealer, you will be responsible for the cost of the extra distance.

FCA US LLC CUSTOMER ASSISTANCE CENTER

P.O. Box 21-8004

Auburn Hills, MI 48321-8004

Phone: (866) 726-4636

FCA CANADA CUSTOMER CARE

P.O. Box 1621

Windsor, Ontario N9A 4H6

Phone: (800) 465-2001 English / (800) 387-9983 French

MEXICO

Customer Relations Office

Av. Prolongacion Paseo de la Reforma, 1240

Sante Fe C.P. 05109

Mexico, CDMX

In Mexico City: 800-505-1300

Outside Mexico City: +(52) 55 50817568

PUERTO RICO AND US VIRGIN ISLANDS

FCA Caribbean LLC Customer Service

P.O. Box 191857

San Juan 00919-1857

Phone: (866) 726-4636

CUSTOMER ASSISTANCE FOR THE HEARING OR SPEECH IMPAIRED (TDD/TTY)

To assist customers who have hearing difficulties, FCA US LLC has installed special TDD (Telecommunication Devices for the Deaf) equipment at its customer center. Any hearing or speech impaired customer, who has access to a TDD or a conventional teletypewriter (TTY) in the United States, can communicate with FCA US LLC by dialing 1-800-380-2479.

Canadian residents with hearing difficulties that require assistance can use the special needs relay service offered by Bell Canada. For TTY teletypewriter users, dial 711 and for Voice callers, dial 1-800-855-0511 to connect with a Bell Relay Service operator.

SERVICE CONTRACT

You may have purchased a service contract for a vehicle to help protect you from the high cost of unexpected repairs after FCA US LLC's New Vehicle Limited Warranty expires. The Mopar® Vehicle Protection plans are the ONLY vehicle extended protection plans authorized, endorsed and backed by

FCA US LLC to provide additional protection beyond your vehicle's warranty. If you purchased a Mopar® Vehicle Protection Plan, you will receive Plan Provisions and an Owner Identification Card in the mail within three weeks of the vehicle delivery date.

If you have any questions about the service contract, call FCA US LLC's Service Contract National Customer Hotline at 1-800-521-9922.

For Canadian residents, you may have purchased additional coverage with an extended service contract. FCA Canada Inc. stands fully behind its service contracts. Be sure that the one you buy is a genuine Canada Inc. service contract. We are not responsible for other companies' contracts. If you purchased a contract other than a genuine FCA Canada Inc. service contract and you have a problem, you will have to contact the administrator of that contract for resolution.

If you have any questions about the service contract, call the FCA's Service Contract National Customer Hotline at (800) 465-2001 English / (800) 387-9983 French).

FCA US LLC is not responsible for any service contract you may have purchased from another manufacturer. If you require service after the FCA US LLC New Vehicle Limited Warranty expires, please refer to the contract documents, and contact the person listed in those documents.

We appreciate that you have made a major investment when you purchased the vehicle. An authorized dealer has also made a major investment in facilities, tools, and training to assure that you are absolutely delighted with the ownership experience.

WARRANTY INFORMATION

See the Warranty Information for the terms and provisions of FCA US LLC warranties applicable to this vehicle and market. Refer to www.mopar.com/om for further information.

See the Warranty Information for the terms and provisions of FCA Canada Inc. warranties applicable to this vehicle and market. Refer to www.owners.mopar.ca/en for further information.

For French, refer to www.owners.mopar.ca/fr for further information.

Scan this QR code to learn more about Warranty Information.



MOPAR® PARTS

Mopar® original equipment parts & accessories and factory filled fluids are available from an authorized dealer. They are recommended for your vehicle to keep it operating at its best and maintain its original condition.

REPORTING SAFETY DEFECTS

IN THE 50 UNITED STATES AND WASHINGTON, D.C.

If you believe that your vehicle has a defect that could cause a crash or cause injury or death, you should immediately inform the National Highway Traffic Safety Administration (NHTSA) in addition to notifying FCA US LLC.

If NHTSA receives similar complaints, it may open an investigation, and if it finds that a safety defect exists in a group of vehicles, it may order a recall and remedy campaign. However, NHTSA cannot become involved in individual problems between you, an authorized dealer or FCA US LLC.

To contact NHTSA, you may call the Vehicle Safety Hotline toll free at 1-888-327-4236 (TTY: 1-800-424-9153); or go to <http://www.safercar.gov>; or write to: Administrator, NHTSA, 1200 New Jersey Avenue, SE., West Building, Washington, D.C. 20590. You can also obtain other information about motor vehicle safety from <http://www.safercar.gov>.

IN CANADA

If you believe that your vehicle has a safety defect, you should contact the Customer Service Department immediately. Canadian customers who wish to report a safety defect to the Canadian government should contact Transport Canada, Motor Vehicle Defect Investigations and Recalls at 1-800-333-0510 or go to www.apps.tc.gc.ca/Saf-Sec-Sur/7/PCDB-BDPP.

ORDERING AND ACCESSING ADDITIONAL OWNER'S INFORMATION

To order the following manuals, you may use either the website or the phone numbers listed below.

Service Manuals

These comprehensive Service Manuals provide a complete working knowledge of the vehicle, system, and/or components and is written in straightforward language with illustrations, diagrams, and charts.

Diagnostic Procedure Manuals

Diagnostic Procedure Manuals are filled with diagrams, charts and detailed illustrations. These manuals make it easy to find and fix problems on computer-controlled vehicle systems and features. They show exactly how to find and correct problems, using step-by-step troubleshooting and drivability procedures, proven diagnostic tests and a complete list of all tools and equipment.

To order a digital copy of your Service or Diagnostic Procedure manuals, visit:

www.techauthority.com (US and Canada).

Owner's Manuals

These Owner's Manuals have been prepared with the assistance of service and engineering specialists to acquaint you with specific FCA vehicles.

To access your Owner's Information online, visit www.mopar.com/om (US) or www.owners.mopar.ca/en/ (Canada).

Or visit:

www.techauthority.com to order physical copies of Owner's Manuals (US).

Owner's Manuals, Radio Manuals and Warranty Information Books can be ordered through Archway at:

- 1-800-387-1143 (Canada)

CHANGE OF OWNERSHIP OR ADDRESS

*If you have purchased this vehicle used or have changed your address, please provide the following information and mail to:

FCA US LLC

P.O. Box 21-8008

Auburn Hills, MI 48321-8004

Make sure to include the following:

- Date of Sale (mm/dd/yy)
- Vehicle Identification Number (17 Character ID located on top left of the instrument panel)
- Exact Odometer Reading
- First and Last Name
- Phone Number
- Street Address, City, State and Zip Code
- Email Address

*Applies to US residents only.

GENERAL INFORMATION

The following regulatory statement applies to all Radio Frequency (RF) devices equipped in this vehicle:

This device complies with Part 15 of the FCC Rules and with Innovation, Science and Economic Development Canada license-exempt RSS standard(s). Operation is subject to the following two conditions:

1. This device may not cause harmful interference, and
2. This device must accept any interference received, including interference that may cause undesired operation.

Le présent appareil est conforme aux CNR d'Innovation, Science and Economic Development applicables aux appareils radio exempts de licence. L'exploitation est autorisée aux deux conditions suivantes:

1. L'appareil ne doit pas produire de brouillage, et
2. L'utilisateur de l'appareil doit accepter tout brouillage radioélectrique subi, même si le brouillage est susceptible d'en compromettre le fonctionnement.

La operación de este equipo está sujeta a las siguientes dos condiciones:

1. Es posible que este equipo o dispositivo no cause interferencia perjudicial y
2. Este equipo o dispositivo debe aceptar cualquier interferencia, incluyendo la que pueda causar su operación no deseada.

NOTE:

Changes or modifications not expressly approved by the party responsible for compliance could void the user's authority to operate the equipment.

INDEX

A

- Accessory Drive Belt Inspection 365
- Active Driving Assist System 187, 191
- Active Lane Management System 197
- Adaptive Cruise Control (ACC) (Cruise Control) 166
- Adding Engine Coolant (Antifreeze) 369
- Adding Fuel 204
- Additives, Fuel 412
- Adjust
 - Down 35
 - Forward 35
 - Rearward 35
 - Up 35
- Adjustable Pedals 42
- Air Bag
 - Air Bag Operation 309
 - Air Bag Warning Light 308, 310
 - Enhanced Accident Response 316, 348
 - Event Data Recorder (EDR) 348
 - Front Air Bag 310
 - If Deployment Occurs 315
 - Knee Impact Bolsters 313
 - Maintaining Your Air Bag System 316
 - Maintenance 316
 - Redundant Air Bag Warning Light 308
 - Transporting Pets 328
- Air Bag Light 126, 308, 328
- Air Cleaner, Engine (Engine Air Cleaner Filter) 363
- Air Conditioner Maintenance 363
- Air Conditioner Refrigerant 363, 364
- Air Conditioner System 363
- Air Conditioning 60, 63
- Air Conditioning Filter 66, 364
- Air Conditioning System 65
- Air Conditioning, Operating Tips 65
- Air Filter 363
- Air Pressure
 - Tires 398
- Air Suspension 157, 160
- Alarm
 - Panic 19
 - Security Alarm 25, 129
- Alterations/Modifications
 - Vehicle 12
- Anti-Lock Brake System (ABS) 282
- Anti-Lock Warning Light 129
- Antifreeze (Engine Coolant) 368, 414
 - Disposal 369
- Assist, Hill Start 285
- Audio Systems (Radio) 227
- Auto Down Power Windows 79
- Automatic Door Locks 29
- Automatic Folding Mirrors 48
- Automatic Headlights 54
- Automatic High Beams 54
- Automatic Tailgate Release 84
- Automatic Temperature Control (ATC) 65
- Automatic Transmission 144, 371
 - Adding Fluid 371
 - Fluid And Filter Change 371
 - Fluid Change 371
 - Fluid Level Check 371
 - Fluid Type 371
 - Special Additives 371
- Automatic Transmission Limp Home Mode ... 145
- AutoPark 137
- AUX Camera 204
- Auxiliary Driving Systems 289
- Auxiliary Switches 387
- Axle Fluid 371, 417
- Axle Locker System 162
- Axle Lubrication 371

B

- B-Pillar Location 395
- Back-Up Camera 200
- Battery 127, 361

Disable Vehicle Towing	346
Disposal	
Antifreeze (Engine Coolant)	369
Door Ajar	127, 128
Door Ajar Light	127, 128
Door Locks	
Automatic	29
Doors	26
Driver's Seat Back Tilt	32
Driving	222
Through Flowing, Rising, Or Shallow Standing Water	221
Driving Tips	220
Drowsy Driver Detection	288
Dual Rear Wheels	411
E	
Electric Brake Control System	282
Anti-Lock Brake System	282
Electronic Roll Mitigation	283, 287
Electric Parking Brake	140
Electric Power Steering	163
Electrical Power Outlets	72
Electronic Range Select (ERS)	146
Electronic Stability Control (ESC)	283
Electronic Throttle Control Warning Light	127
Electronically Shifted Transfer Case	147, 149, 151
Emergency Braking	296
Emergency Gas Can Refueling	344

Emergency, In Case Of	
Freeing Vehicle When Stuck	346
Hazard Warning Flasher	331
Jump Starting	342
Emission Control System Maintenance	135
Engine	357
Air Cleaner	363
Block Heater	140
Break-In Recommendations	140
Checking Oil Level	360
Compartment	357-359
Compartment Identification	357-359
Coolant (Antifreeze)	415
Exhaust Gas Caution	329, 330
Fails To Start	139
Flooded, Starting	139
Fuel Requirements	412, 414
Jump Starting	342
Oil	362, 414, 415
Oil Filler Cap	357
Oil Filter	363
Oil Selection	362, 414
Oil Synthetic	362
Overheating	344
Starting	138
Enhanced Accident Response Feature .	316, 348
Entry System, Illuminated	59
Ethanol	413
Exhaust Gas Cautions	329, 330
Exhaust System	329, 367
Exterior Lights	53, 329

F

Filters	
Air Cleaner	363
Air Conditioning	66, 364
Engine Oil	363
Engine Oil Disposal	363
Flash-To-Pass	54
Flashers	
Turn Signals	133, 329
Flat Tire Stowage	340
Fluid Capacities	414
Fluid Leaks	329
Fluid Level Checks	
Brake	370
Engine Oil	360
Fog Lights	56, 390
Fold-Flat Seats	32
Forward Collision Warning	294
Four Wheel Drive	147, 151
Four-Way Hazard Flasher	331
Freeing A Stuck Vehicle	346
Front Axle (Differential)	371
Fuel	412
Adding	204
Additives	412
Clean Air	412
Ethanol	413
Gasoline	412
Light	130
Materials Added	412

Methanol	413
Octane Rating	412, 415
Requirements	412
Tank Capacity	414
Fuses	372

G

Gasoline, Clean Air	412
Gasoline, Reformulated	412
Glass Cleaning	410
Grocery Bag Retainer	38
Gross Axle Weight Rating	207
Gross Combination Weight Rating	207
Gross Trailer Weight	207
Gross Vehicle Weight Rating	206
GVWR	206

H

Hazard	
Driving Through Flowing, Rising, Or Shallow Standing Water	221
Hazard Warning Flashers	331
Head Restraints	38
Head Rests	38
Headlights	389
Cleaning	407
Delay	55
High Beam	54

High Beam/Low Beam Select Switch	54
Lights On Reminder	56
On With Wipers	55
Passing	54
Switch	53
Heads Up Display (HUD)	122
Heated Mirrors	49
Heated Seats	37
Heated Steering Wheel	30
Heater, Engine Block	140
Hill Start Assist	285
Hitches	
Trailer Towing	208
HomeLink® (Garage Door Opener)	50
Hood Release	82
HUD	122, 124

I

Ignition	22
Switch	22
Ignition Park Interlock	143
Illuminated Entry	59
Inside Rearview Mirror	332
Installing Tailgate	88, 93
Instrument Cluster	111, 113, 115
Descriptions	110, 111
Display	116
Engine Oil Reset	118
Location And Controls	116
Menu Items	119

Instrument Cluster Display

Audio	122
Driver Assist	119
Fuel Economy	120
Off-Road	121
Speedometer	119
StopStart	120
Stored Messages	122
Trailer Tow	122
Trip	121
Vehicle Info	119
Instrument Panel Lens Cleaning	409
Integrated Trailer Brake Control	214
Interior Appearance Care	408
Interior Lights	57
Inverter Outlet (115V)	75

J

Jack Location	334
Jump Starting	342

K

Key Fob	19
Panic Alarm	19
Programming Additional Key Fobs	21
Key Fob Battery Replacement	20
Key Fob Programming (Remote Keyless Entry)	21
Keyless Enter 'n Go™	28, 138

Passive Entry	28
Keys	17, 19

L

Lane Change Assist	56
Lap/Shoulder Belts	303
Latches	329
Hood	82
Lead Free Gasoline	412
Leaks, Fluid	329
Life Of Tires	400
Light	
Air Suspension	132
Light Bulbs	329, 389
Lights	329
4WD	133
Air Bag	126, 308, 328
Air Suspension Fault	129
Brake Assist Warning	285
Brake Warning	127
Bulb Replacement	389
Cargo	56, 132
Center Mounted Stop	391
Courtesy/Reading	57
Cruise	133, 134
Daytime Running	54
ECO Mode	133
Electric Power Steering	127
Electronic Stability Program(ESP)	
Indicator	128

Exterior	53, 329
Fog	133, 390
Hazard Warning Flasher	331
Headlights	53, 54
High Beam	54, 134
High Beam/Low Beam Select	54
Hood Open	128
Illuminated Entry	59
Interior	57
Lights On Reminder	56
NEUTRAL	132
Oil Temperature	128
Park	133
Passing	54
Rear Axle Lock	130, 132
Rear Tail Lamps	390
Seat Belt Reminder	128
Security Alarm	129
Service	389
Service Forward Collision	130
Service Stop Start	130
Stop Start Active	133
Traction Control	285
Trailer Brake Disconnected	128
Transmission Temperature	128
Turn Signals	389
Warning Instrument Cluster	
Descriptions	126, 128
Limited-Slip Differential	163, 372
Load Shed Battery Saver Mode	125
Load Shed Battery Saver On	125

Load Shed Electrical Load Reduction	125
Load Shed Intelligent Battery Sensor	125
Loading Vehicle	205
Tires	395
Locks	
Automatic Door	29
Child Protection	29
Power Door	27
Low Tire Pressure System	297
Lubrication, Body	366
Lug Nuts	411
Lug Nuts/Bolts	411

M

Maintenance	81, 82
Maintenance Free Battery	361
Maintenance Schedule	349, 353
Malfunction Indicator Light (Check Engine) ..	130
Manual	
Service	421
Media Hub	70
Memory Seat	31
Memory Settings	31
Methanol	413
Mirror, Digital Rearview	43
Mirror, Digital Trailer Camera	43
Mirrors	
Automatic Dimming	43
Electric Powered	47
Heated	49

Inside Rearview Mirror	43
Manual Dimming	43
Memory	31
Outside	45
Power Folding	47
Rearview	43, 332
Trailer Towing	46
Vanity	45
Modifications/Alterations	
Vehicle	12
Monitor, Tire Pressure System	297
Mopar Parts	420
MP3 Control	70
Multi-Function Control Lever	54
Multifunction Tailgate	85
N	
Navigation	121
New Vehicle Break-In Period	140
O	
Occupant Restraints	302
Octane Rating, Gasoline (Fuel)	412
Off Road Pages	275
Accessory Gauges	277
Pitch And Roll	277
Status Bar	275
Vehicle Dynamics	276

Off-Pavement Driving (Off-Road)	221
Off-Road Driving (Off-Pavement)	221
Oil Filter, Change	363
Oil Filter, Selection	363
Oil Pressure Light	128
Oil, Engine	362, 415
Capacity	414
Checking	360
Dipstick	360, 361
Disposal	363
Filter	363
Filter Disposal	363
Identification Logo	362
Materials Added To	363
Pressure Warning Light	128
Recommendation	362, 414
Synthetic	362
Viscosity	414
Onboard Diagnostic System	135
Operating Precautions	135
Operator Manual	
Owner's Manual	421
Outside Rearview Mirrors	45
Overheating, Engine	344
P	
Paint Care	407
Panic Alarm	19
Parking Brake	140
Parking Lights	55

ParkSense	
Front And Rear	175
ParkSense Active Park Assist	180
Full Assist Mode	182
Steering-Only Mode	185
ParkSense System, Rear	175
Passenger Screen	256
Passive Entry	28
Pedals, Adjustable	42
Pedestrian Warning System	288, 296
Performance Features	120
Permissions	256
Pets	328
Pickup Box	96, 98
Pinch Protection	80, 82
Placard, Tire And Loading Information	395
Power	
Distribution Center (Fuses)	373, 380
Door Locks	27
Mirrors	47
Outlet (Auxiliary Electrical Outlet)	72, 75
Outside Mirror Lights	49
Seats	34
Side Steps	27
Sliding Rear Window	79
Steering	163
Sunroof	80, 81
Windows	78
Power Seats	
Down	35
Forward	35

Rearward	35
Recline	35
Tilt	35
Up	35
Power Steering	163
Pregnant Women And Seat Belts	306
Pressure Washing	362
Pretensioners	
Seat Belts	306
Profile Settings	231

R

Radial Ply Tires	399
Radiator Cap (Coolant Pressure Cap) ...	368, 369
Radio	
Off Road Pages	275
Settings	227
Sound Setting	250
Radio Operation	274
Radio Remote Controls	255
Rain Sensitive Wiper System	60
RamBox	98
RamBox Safety	100
Rear Axle (Differential)	371
Rear Cargo Area Utility Rails	97
Rear Cross Path	291
Rear ParkSense System	175
Rear Seat Reminder Alert	289
Reclining Rear Seats	34
Recreational Towing	218
Four-Wheel Drive Models	219
Shifting Into Transfer Case Neutral (N)	219
Shifting Out Of Transfer Case Neutral (N)	220
Two-Wheel Drive Models	218
Reformulated Gasoline	412
Refrigerant	364
Release, Hood	82
Release, Tailgate	83
Reminder, Seat Belt	303
Remote Keyless Entry	
Panic Alarm	19
Programming Additional Key Fobs	21
Remote Lowering	
Air Suspension	20
Remote Sound System (Radio) Control	255
Remote Start (Gasoline)	23
Remote Starting	
Comfort Systems	25
Exit Remote Start Mode	24
Remote Starting System	23
Remove, Tailgate	86, 90
Replacement Bulbs	389
Replacement Tires	400
Reporting Safety Defects	421
Restraints, Child	317
Restraints, Head	38
Rotation, Tires	405
Rough Road Cruise Control	174

S

Safety Checks Inside Vehicle	328
Safety Checks Outside Vehicle	329
Safety Defects, Reporting	421
Safety Information, Tire	391
Safety Tips	328
Safety, Exhaust Gas	329
Schedule, Maintenance	349, 353
Screen, Passenger	256
Seat Belt Reminder	128
Seat Belts	302, 328
Adjustable Shoulder Belt	305
Adjustable Upper Shoulder Anchorage	305
Adjustable Upper Shoulder Belt	
Anchorage	305
Automatic Locking Retractor (ALR)	306
Child Restraints	317
Extender	306
Front Seat	302-304
Inspection	328
Lap/Shoulder Belt Operation	304
Lap/Shoulder Belt Untwisting	305
Lap/Shoulder Belts	303
Operating Instructions	304
Pregnant Women	306
Pretensioners	306
Rear Seat	303
Reminder	303
Seat Belt Extender	306
Seat Belt Pretensioner	306

Seat Belt Reminder	303	Sliding Rear Window, Power	79	Sunglasses Storage	68
Untwisting Procedure	305	Snow Chains (Tire Chains)	403	Sunshade Operation	81, 82
Seat Belts Maintenance	409	Snow Tires	401	Surround View Camera	201
Seats	32, 33, 35	Spare Tires	401, 402	Suspension	
Adjustment	32, 35	Starting	137, 138	Air	157, 160
Easy Entry	36	Automatic Transmission	137	Sway Control, Trailer	287
Head Restraints	38	Button	22	Symbol Glossary	12
Lumbar Adjustment	35	Engine Fails To Start	139	Synthetic Engine Oil	362
Memory	31	Starting And Operating	138		
Power	34	Starting Procedures	138		
Power Massage	36	Steering			
Rear Folding	32	Power	163		
Reclining Rear	34	Tilt Column	30	Tailgate	83
Tilting	32	Wheel, Heated	30	Tailgate Removal	86, 90
Second Row USB	70	Wheel, Tilt	30	Tailgate, Electronic Lowering	84
Security System	25, 129	Wheel, Voice Recognition	41	Tailgate, Multifunction	85
Selec - Speed Control	154, 286	Steering Wheel Audio Controls	255	Telescoping Steering Column	30
Selection Of Coolant (Antifreeze)	415	Steering Wheel Mounted Sound System	255	Temperature Control, Automatic (ATC)	65
Sentry Key (Immobilizer)	22	Steps, Power Side	27	Tilt	
Service Assistance	418	Stop/Start	164	Down	35
Service Contract	420	Storage	66	Up	35
Service Manuals	421	Below Seat	70	Tilt Steering Column	30
Shifting	143	Door	66	Tip Start	138
Automatic Transmission	144	Front Bench Seat	68	Tire And Loading Information Placard	395
Transfer Case, Shifting Into Transfer		Glove Compartment	66	Tire Identification Number (TIN)	393
Case Neutral (N)	219	In Floor	69	Tire Markings	391
Transfer Case, Shifting Out Of Transfer		Rear Console	69	Tire Safety Information	391
Case Neutral (N)	220	Storage Compartment, Center Seat	67	Tire Terminology And Definitions	394
Shoulder Belts	303	Storage, Vehicle	65, 406	Tires	329, 397, 401, 405
Side Steps, Power	27	Storing Your Vehicle	406	Aging (Life Of Tires)	400
Signals, Turn	56, 133, 329	Sun Roof	80-82	Air Pressure	397
				Chains	403

T

Compact Spare	401	Weight	209	Tri-Fold Tonneau Cover	102
Dual	411	Towing Behind A Motorhome	218	Cleaning	108
General Information	397, 401	Traction	220	Install	106
High Speed	398	Traction Control	287	Removal	103
Inflation Pressure	398	Traffic Sign Recognition System	132, 173	Turn Signals	56, 133, 389, 390
Life Of Tires	400	Trailer Reverse Steering Control	209, 211		
Load Capacity	395, 396	Trailer Sway Control (TSC)	207, 287		
Pressure Monitoring System (TPMS)	131, 297	Trailer Tire Pressure	300		
Quality Grading	405	Trailer Tow Pages	279		
Radial	399	Trailer Towing	206		
Replacement	400	Frontal Area	207	U	
Rotation	405	Hitches	208	Uconnect	
Run Flat	399	Minimum Requirements	213	Uconnect Settings	227
Safety	391, 397	Mirrors	46	Uconnect (Radio)	227
Sizes	392	Tips	217	Uconnect Settings	
Snow Tires	401	Trailer And Tongue Weight	209	Customer Programmable Features	28, 228
Spare Tires	401, 402	Weight Carrying Hitch	207	Passive Entry Programming	28
Spinning	399	Weight Distributing Hitch	207	Uniform Tire Quality Grades	405
Trailer Towing	213	Wiring	216	Unleaded Gasoline	412
Tread Wear Indicators	399	Trailer Towing Guide	209	Untwisting Procedure, Seat Belt	305
Types	400	Trailer Weight	209	USB	70
Wheel Nut Torque	411	Transfer Case	372	Utility Rails, Rear Cargo Area	97
To Open Hood	82	Electronically Shifted	147, 149, 151		
Tongue Weight/Trailer Weight	207, 209	Fluid	417	V	
Tonneau Cover	102, 407	Transmission	144	Vehicle Identification Number (VIN)	411
Tonneau Cover Cleaning	407	Automatic	144, 371	Vehicle Loading	205, 396
Tow/Haul Mode	146	Fluid	417	Vehicle Maintenance	362
Towing	206, 346	Maintenance	371	Vehicle Modifications/Alterations	12
Disabled Vehicle	346	Shifting	143	Vehicle Settings	227
Guide	209	Transporting Pets	328	Vehicle Storage	65, 406
Recreational	218	Tread Wear Indicators	399	Ventilated Seats	37

Voice Command	41
Voice Recognition System (VR)	41

W

Warranty Information	420
Washers, Windshield	361
Washing Vehicle	407
Water	
Driving Through	221
Wheel And Wheel Tire Care	402
Wheel And Wheel Tire Trim	402
Wind Buffeting	80
Window Fogging	65
Window Lockout Switch	79
Windows	78
Power	78
Reset Auto-Up	79
Windshield Defroster	328
Windshield Washers	59, 361
Fluid	361
Windshield Wiper Blades	366
Windshield Wipers	59
Wipers Blade Replacement	366
Wipers, Rain Sensitive	60
Wireless Charging Pad	76

DRIVING AND ALCOHOL

Drunk driving is one of the most frequent causes of accidents. Your driving ability can be seriously impaired with blood alcohol levels far below the legal minimum. If you are drinking, don't drive. Ride with a designated non-drinking driver, call a cab, a friend or use public transportation.

WARNING

Driving after drinking can lead to an accident. Your perceptions are less sharp, your reflexes are slower and your judgment is impaired when you have been drinking. Never drink and then drive.



The driver's primary responsibility is the safe operation of the vehicle. Driving while distracted can result in loss of vehicle control, resulting in an accident and personal injury. FCA US LLC strongly recommends that the driver use extreme caution when using any device or feature that may take their attention off the road. Use of any electrical devices, such as cellular telephones, computers, portable radios, vehicle navigation or other devices, by the driver while the vehicle is moving is dangerous and could lead to a serious accident. Texting while driving is also dangerous and should never be done while the vehicle is moving. If you find yourself unable to devote your full attention to vehicle operation, pull off the road to a safe location and stop your vehicle. Some states or provinces prohibit the use of cellular telephones or texting while driving. It is always the driver's responsibility to comply with all local laws.

This Owner's Manual has been prepared to help you get acquainted with your new Ram brand vehicle and to provide a convenient reference for common questions.

Not all features shown in this manual may apply to your vehicle. For additional information on accessories to help personalize your vehicle, visit mopar.com/om (USA), owners.mopar.ca (Canada) or your local Ram brand dealer.

This Owner's Manual is intended to familiarize you with the important features of your vehicle. Your most up-to-date Owner's Manual, Radio Instruction Manual and Warranty Booklet can be found by visiting the website on the back cover.



Whether it is providing information about specific product features, taking a tour through your vehicle's heritage, knowing what steps to take following an accident or scheduling your next appointment, we know you will find the app an important extension of your Ram vehicle. Simply download the app, select your make and model and enjoy the ride. To get this app, go directly to the App Store® or Google Play® Store and enter the search keyword "ram toolbox" (U.S. residents only).

DOWNLOAD THE MOST
UP-TO-DATE OWNER'S
MANUAL, RADIO AND
WARRANTY BOOKS

US



[MOPAR.COM/OM](https://mopar.com/om)

CANADA



[OWNERS.MOPAR.CA](https://owners.mopar.ca)